

Contents Nutrient Management (NM)

Nutrient Management Fundamentals

Nutrient Management Practices for WI Corn Production & Water Quality Protection (UWEX A3557)
Sampling Soils for Testing (UWEX A2100)
Optimum Soil Test Levels for Wisconsin (A3030)
Soil and Applied Nitrogen (UWEX A2519)
Soil and Applied Phosphorus (UWEX A2520)
Soil and Applied Potassium (UWEX A2521)
Plant Nutrient Deficiency Symptoms
Nutrient Deficiencies and Application Injuries in Field Crops Bulletin
Sampling for Plant Analysis (UWEX A2289)
Soil Compaction: Causes, Concerns and Cures (UW3367)
Soil Quality Resource Concerns: Compaction
Soil Quality Indicators: Soil Crusts
Soil Quality Indicators: Aggregate Stability
Soil Quality Indicators: Organic Matter
Indicators for Soil Quality Evaluation

Nutrient Management Planning

Nutrient Management Standard 590: Criteria Summary - ver. 7/02
Nutrient Management Standard 590: Criteria Summary - ver. 3/99
A Step by Step Guide to Nutrient Management (UWEX A3568)
What is a Farm Nutrient Management Plan

Publications

Know How Much You Haul
Nutrient Management Fast Facts
Soil Testing Basics
Nitrogen Guidelines for Corn in Wisconsin

A3557

University of Wisconsin-Extension - Cooperative Extension
College of Agricultural and Life Sciences, University of Wisconsin - Madison

Nutrient Management

Practices for Wisconsin Corn Production and Water Quality Protection



Introduction

Soil nutrients, like all agricultural inputs, need to be managed properly to meet the fertility requirements of corn without adversely affecting the quality of our water resources. The corn nutrients of greatest concern relative to water quality are nitrogen (N) and phosphorus (P). Nitrogen not recovered by a corn crop can contribute nitrate to groundwater through leaching. Nitrate is the most common groundwater contaminant found in Wisconsin, and the United States as a whole. Nitrate levels that exceed the established drinking water standard of 10 ppm nitrate-N have the potential to adversely affect the health of infants and livestock. Surface water quality is the concern with P management. Erosion and runoff from fertile cropland add nutrients to surface waters that stimulate the excessive growth of aquatic weeds and algae. Of all crop nutrients, P is the most important to prevent from reaching surface water since the biological productivity of aquatic plants and

algae is most limited by its availability. Consequences of increased aquatic plant and algae growth include the depletion of dissolved oxygen contents of lakes resulting in fish kills, as well as reduced aesthetic and recreational values of lakes.

Appropriate nutrient management practices for corn production vary widely due to cropping, topographical, environmental, and economic conditions. With the variety of factors to consider in corn fertility management, it is nearly impossible to recommend best management practices applicable to all Wisconsin farms. Nutrient management practices for preserving water quality while maintaining or improving farm profitability must be tailored to the unique conditions of individual farms. A number of options for improved nutrient management are available to Wisconsin corn growers and are discussed in this publication.

Nutrient Application Rates

The most important consideration in sound nutrient management for corn production is application rate. Nutrient applications in excess of crop needs are unwise from both an environmental and economic viewpoint. Applications of N greater than corn requirements increase the potential for nitrate leaching to groundwater. Similarly, over-applications of P can increase the detrimental impacts of cropland runoff and erosion on surface water quality.

Soil nutrients removed from cropping systems via leaching or erosion are investments lost by the grower. However, soil nutrient levels that are inadequate to meet the requirements of a crop often result in yields below those needed for reasonable profit. Because of the overall importance of nutrient application rates, accurate assessments of corn nutrient needs are essential for minimizing threats to water quality while maintaining economically sound production. Soil testing is imperative in the accurate determination of supplemental fertilizer requirements of corn.

Wisconsin Soil Test Recommendations

The importance of a regular soil testing program has long been recognized by most corn growers. The goals of Wisconsin's soil testing program are to determine existing levels of available soil nutrients and recommend fertilizer applications to prevent any nutrient deficiency which may hinder crop production. Proper soil testing will give a relative index of soil supplied nutrients and nutrients previously supplied from manure, legume crops or commercial fertilizer. When the nutrient supply drops below a "critical" level for a particular soil and crop, yield reduction will occur. Since nutrient demands are not uniform throughout the entire growing season, an adequate supply must be planned for the period of peak demand. Supplemental fertilizer applications based on soil test results allow the nutrient demand to be met. As farmers apply increasing amounts of nutrients, and as soil fertility levels increase, water quality problems associated with excess nutrients may become evi-



dent. At this point, soil tests are needed to keep soils within optimum nutrient supply ranges.

The Wisconsin soil testing program is research-based, reflects environmental concerns, and recognizes the need for profitability in crop production. Soil testing has some limitations, but it is the best available tool for predicting crop nutrient needs. Nutrient application recommendations can only be accurate if soil samples representative of the field of interest are collected. Complete instructions for proper soil sampling are included in UWEX publication A2100, *Sampling Soils for Testing*. Samples that are unrepresentative of fields often result in recommendations that are misleading. In addition, field history information must be provided with the soil samples in order to accurately adjust the fertility recommendations to account for nutrient credits from field-specific activities such as manure applications and legumes in the rotation.

Table 1. Nitrogen recommendations for corn.

Soil organic matter (%)	Sands and loamy sands		Other soils	
	Irrigated	Non-irrigated	Medium and low yield potential ¹	Very high and high yield potential ¹
	----- (lbs N/a) -----			
< 2.0	200	120	150	180
2.0 – 9.9	160	110	120	160
10.0 – 20.0	120	100	90	120
> 20.0	80	80	80	80

¹ To determine soil yield potential, see Table 16 of UWEX bulletin A2809, **Soil Test Recommendations for Field, Vegetable, and Fruit Crops**, or contact your agronomist or county agent.

Users of the University of Wisconsin N recommendations should be aware of the relationship between increased returns from the use of N at rates needed for economic optimum yields and the risk of nitrate loss to groundwater. The data illustrated in Table 2 provide a typical example of the relationships among N rate, yield, profitability, and crop recovery of applied N. In this case, it is clear that yields and economic return increase up to the 160 lb N/acre rate. However, crop recovery of N decreases and the potential

for nitrate loss to the environment increases as N rates are increased to, and especially above, the economic optimum. Although the risk of nitrate loss to groundwater is lower at N rates below the economic optimum, yields and economic returns are also likely to be lower.

Methods for Improving Nitrogen Recommendations

The recent development of soil tests for assessing soil N levels has provided new tools for improving the efficiency of N fertilizer applications to corn. Soil testing for N allows corn N recommendations to be adjusted for the numerous year and site-specific conditions that can influence N availability. Two soil N tests are currently available. One is a technique for assessing N requirements based on measuring the residual soil profile nitrate present before planting. The other is a pre-sidedress soil nitrate test that provides an index of N availability and predicts sidedress N requirements.

In humid climates such as Wisconsin, it had been assumed that N applied to crops was utilized, immobilized, or lost through leaching or denitrification prior to the following growing season. However, research has shown that in some years, significant amounts of residual nitrate remain in the root zone where it can be utilized by subsequent crops. Soil nitrate testing can determine the amount of nitrate-N that has “carried-over” from the previous growing season and is available to crops. Nitrogen fertilizer recommendations in fields where a soil nitrate test has been used can be reduced to reflect the soil’s residual nitrate content. Crediting residual nitrate not only reduces fertilizer costs; it also aids in reducing risks of nitrate movement to groundwater due to N application in excess of crop needs.

Figure 2. The separation of very high/high and medium/low yield potential soils according to 2,300 growing degree day (GDD) accumulation and county boundaries (2,300 GDD = May 1 to Sept. 30, 50° base).

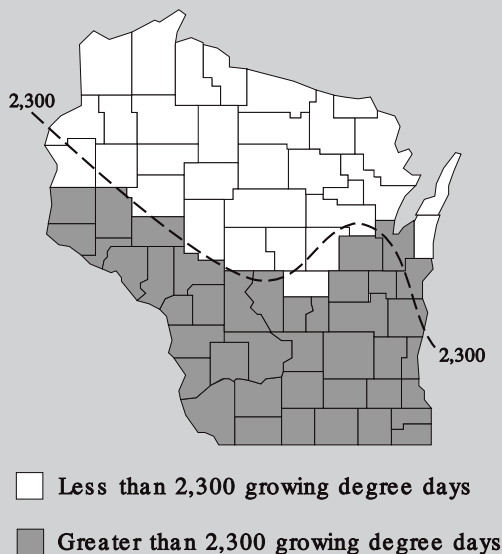

The potential for nitrate to remain in a soil profile from the previous growing season is affected by soil texture and precipitation amounts (Table 3). Generally, nitrate is more likely to accumulate on silt loam or heavier textured soils. Nitrate-N carry-over on sandy soils is not expected, and neither the preplant or pre-sidedress nitrate test is recommended on sands. The potential for nitrate carry-over is greatest when:

- ❑ precipitation during the previous growing season and over-winter period is normal or below normal
- ❑ the amount of previously applied N (including manure and legumes) was greater than the crop's need
- ❑ pest problems or climatic conditions limited crop uptake of N during the previous growing season.

Preplant Soil Nitrate Test

A preplant soil nitrate test involves deep soil sampling in the spring prior to both corn planting and any N applications. Soil samples need to be collected in one foot increments to a depth of two feet. Previously, the suggested sampling depth was three feet. The amount of nitrate-N in the third foot is now estimated based on the nitrate content in the top two feet—unless samples are taken to the three foot depth.

Early spring sampling measures only the nitrate form of N in the soil. Preplant soil nitrate test samples are usually collected too early in the growing season to measure N released from fall or spring manure applications, previous

legume crops, and soil organic matter. However, if background information on field management is provided with the soil samples, standard N credits for manure, legumes and organic matter are deducted from the N fertilizer recommendation. Because soil sampling occurs too early to measure the N contributions from legumes, the preplant nitrate test is most useful in years of corn following corn in a rotation. If corn follows a forage legume (alfalfa), the test is not needed; however, the standard N credit for the previous legume crop should be taken or the pre-sidedress soil nitrate test could be used.

Sampling procedures for the preplant soil nitrate test and information on sample handling are available from your local UWEX office, as well as in UWEX publication A3512 *Wisconsin's Preplant Soil Profile Nitrate Test*.

Pre-sidedress Soil Nitrate Test

The pre-sidedress soil nitrate test is another method available to corn growers for improving the efficiency of N applications. Unlike preplant soil nitrate test samples, soil samples for the pre-sidedress nitrate test are collected only to a depth of one foot when corn plants are 6 to 12 inches tall, usually four to six weeks after planting. Mineralization of organic N to the plant-available nitrate form has usually occurred by the time pre-sidedress samples are collected. Consequently, this soil test can measure the amount of N released from previous legumes, fall/spring manure applications, and soil organic matter as well as residual nitrate in the top foot of soil. The pre-sidedress soil nitrate test can be a valuable tool for growers wanting to confirm the amount of N credited from manure or previous legume crops.

Table 2. Yield, economic return, and recovery of applied N with 40 lb/a increments of fertilizer N applied to continuous corn. Janesville, Wisconsin, 1983–85.¹

N rate (lb/a)	Yield (bu/a)	Value of yield increase (\$/a)	Return (\$/a)	N recovery in grain	
				Incremental (%)	Total (%)
0	93	—	—	—	—
40	115	44	38	45	45
80	131	32	26	45	40
120	138	14	8	20	37
160	144	12	6	17	32
200	145	2	-4	0	25

¹ Assumes \$0.15/lb for N and \$2.00/bu for corn.

Table 3. Relative effects of soil texture, and previous growing season and over-winter precipitation on nitrate-N carry-over potential.

Soil Texture	Precipitation		
	Below Normal	Normal	Above Normal
Sand	Low	Low	Low
Loam	High	Medium	Low
Silt loam, & finer	High	High	Low

Pre-sidedress nitrate test results are interpreted using a critical value of 21 ppm nitrate-N. Fields testing above 21 ppm N will most likely *not* respond to additional N. Fields testing below 21 ppm N will likely respond to additional N. Recent research showing a relationship between pre-sidedress test results and soil yield potential has improved



the usefulness of the test for determining N application rates at soil test levels below the critical value of 21 ppm N. Specific N rate recommendations for corn at various pre-sidedress test results are shown in Table 4.

Growers using the pre-sidedress rather than the pre-plant nitrate test have the advantage of a less labor-intensive sample collection procedure which can reduce the amount of time spent soil sampling. However, use of the pre-sidedress nitrate test may have some disadvantages to corn growers. Obviously, growers using the pre-sidedress test are locked into applying any supplemental N as a sidedress application. This removes some flexibility in the type of N fertilizer and fertilizer application method that can be used. An additional consideration when using the pre-sidedress test is time. Use of this test requires that soil sampling, laboratory analysis, and sidedress N applications all occur during a short period of time (one to two weeks) when a grower may be committed to other farm operations, such as cultivating, haying, etc.

Nitrogen recommendations based on either soil nitrate test are offered by University of Wisconsin labs in Madison and Marshfield and by several commercial soil testing labs. The names of commercial labs performing these tests are available from county UWEX offices.

Table 4. Corn nitrogen recommendations based on the pre-sidedress soil nitrate test (PSNT).

PSNT Result	Soil Yield Potential ¹	
	Very High/High	Medium/Low
N	N Application Rate	
--- (ppm) ---	----- (lb/a) -----	
≥ 21	0	0
20–18	60	40
17–15	100	40
14–13	125	80
12–11	150	80
≤ 10	160 ²	120 ²

¹ To determine a soil's yield potential, consult UWEX publication A2809, Soil test recommendations for field, vegetable and fruit crops, or contact your agronomist or county agent.

² Unadjusted nitrogen application rate.

Phosphorus

Careful management of phosphorus (P) in corn production is essential for preventing nutrient enrichment of surface waters. Contributions of P to surface waters have been shown to increase with increasing rates of applied P. Fertilizer applications at rates higher than crop utilization are unwise from both an environmental and economic viewpoint. Using soil tests to determine crop P needs, setting realistic crop yield goals, and taking appropriate nutrient credits are techniques which will reduce environmental risk and increase economic benefits.

To avoid over-fertilization with P and other nutrients, fertilizer additions should be made according to soil test results. Regular and systematic soil testing is required for determining P application rates. The University of Wisconsin soil testing system recommends soil nutrient applications at levels which in combination with nutrients supplied by the soil result in the best economic return for the grower. This reliance on both soil-supplied and supplemental nutrients reduces threats to water quality by avoiding excessive nutrient applications. At optimum soil test levels, the recommended P and potassium (K) additions are approximately equal to anticipated crop removal and are needed to optimize economic return and maintain soil test levels in the optimum range. Additions of P and K at optimum soil test levels are *essential* to prevent reductions in yields and profits.

The soil test recommendation program de-emphasizes the former build-up/maintenance philosophy in favor of a better balance between environmental and economic con-

siderations. As a result, soil fertility levels have the potential to drop below economically productive thresholds in only a few growing seasons. To prevent this, soil test levels need to be monitored closely to detect changes in P and K status. It is recommended that soil tests be taken at least every three years and preferably every other year on sandy and other soils of low buffering capacity. Detailed information on soil test recommendations is available in UW-Extension publication A2809, *Soil Test Recommendations for Field, Vegetable and Fruit Crops*.

Optimum soil test levels for P and other nutrients for corn production in Wisconsin are given in Table 5. Corn fertilizer recommendations for P and K are based on yield goals and soil test results as shown in Table 6. Note that soil test levels for P and K are reported in parts per million (ppm).

Realistic Yield Goals

As shown in Table 6, an important criteria in the recommendation of appropriate P and K application rates for corn is the determination of realistic yield goals. Yield goal estimates that are too low will underestimate P and K needs and could inhibit corn yield. Yield goal estimates that are too high will overestimate corn needs and will result in soil nutrient levels beyond those needed by the crop which could increase the likelihood for nutrient contributions to surface waters.

Table 5. Optimum Wisconsin test levels for corn.

Soil test	Medium & fine textured soils			Sandy soils	Organic soils
	Southern & Western	Eastern Red	Northern		
	----- (ppm) -----				
Available Phosphorus	11–20	16–20	13–18	23–32	23–32
Exchangeable Potassium	81–110	81–110	101–130	66–90	66–90
Calcium	600–1,000	600–1,000	600–1,000	400–600	600–1,000
Magnesium	100–500	100–500	100–500	50–250	100–500
Sulfur	30–40	30–40	30–40	30–40	30–40
Manganese	10–20	10–20	10–20	10–20	10–20
Zinc	3–20	3–20	3–20	3–20	3–20
Boron	0.9–1.5	0.9–1.5	0.9–1.5	0.5–1.0	1.1–2.0

Yield goals must be realistic and achievable based on recent yield experience. Estimates used to determine corn P and K requirements should be cautiously optimistic but not more than 10 to 20% above the recent average corn yield from a particular field. Yield goals 10 to 20% higher than a 3-to 5-year average yield are suggested because annual yield variations due to factors other than nutrient application rates (primarily climatic factors) are often large.

Critical to successful estimation of corn yield goals is the keeping of **accurate records** containing corn yields from specific fields. Absence of crop yield records can result in other, less reliable, estimates being used in the determination of corn P and K requirements. It is strongly recommended that growers develop or maintain accurate corn yield records. The information gathered from such records can increase production efficiency and minimize threats to water quality.

Table 6. Corn fertilization recommendations for phosphate and potash at various soil test interpretation levels.

Yield goal (bu/a)	Soil test interpretation ¹				
	Very Low ²	Low ²	Optimum	High	Excessively High ³
	----- P ₂ O ₅ , (lb/a) -----				
71–90	60–90	50–70	30	15	0
91–110	70–100	60–80	40	20	0
111–130	75–105	65–85	45	25	0
131–150	85–115	75–95	55	25	0
151–170	90–120	80–100	60	30	0
171–190	100–130	90–110	70	35	0
191–220	105–135	95–115	75	40	0
	----- K ₂ O, (lb/a) -----				
71–90	50–80	40–65	25	15	0
91–110	55–85	45–70	30	15	0
111–130	60–90	50–75	35	15	0
131–150	65–95	55–80	40	20	0
151–170	70–100	60–85	45	20	0
171–190	75–105	65–90	50	20	0
191–220	80–110	70–95	55	25	0

¹ Where corn is harvested for silage, an additional 30 lb P₂O₅/a and 90 lb K₂O/a should be applied to the subsequent crop if soil tests are optimum or below.

² For phosphate, use the higher values on sandy or organic soils and lower values for other soils. For potash, use the lower values on sandy or organic soils and higher values for other soils.

³ Use a small amount of starter fertilizer on soils that warm slowly in spring (a minimum addition is considered 5, 10, 10 lb/a of N, P₂O₅, and K₂O, respectively).

Nutrient Crediting

The best integration of economic return and environmental quality protection is provided by considering nutrients from all sources. In the determination of supplemental fertilizer application rates, it is critical that nutrient contributions from manure, previous crops grown in the rotation, and land-applied organic wastes are credited. Both economic and environmental benefits can result if the nutrient supplying capacity of these nutrient sources is correctly estimated. Economically, commercial fertilizer application rates can often be reduced or eliminated entirely when nutrient credits are properly assessed. Environmentally, the prevention of over-fertilization reduces potential threats to water quality. The use of appropriate nutrient credits is of particular importance in Wisconsin where manure applications to cropland and legume crop production are common.

Manure

Manure can supply crop nutrients as effectively as commercial fertilizers in amounts that can meet the total N and P requirements of corn. In order to utilize manure efficiently, the application rate and nutrient supplying capacity need to be estimated. Guidelines for determining rates of application can be found in UWEX publication A3537, *Nitrogen Credits for Manure Applications*. The most effective method for gauging the nutrient content of manure is to have samples analyzed by a commercial or university laboratory. Large farm-to-farm variation can occur in nutrient content due to manure storage, handling, livestock feed, or other farm management differences. Unfortunately, laboratory analysis is not always convenient or available; in such instances, estimates of crop nutrients supplied by animal manures should be made. Table 7 summarizes the University of Wisconsin recommendations for average nutrient values of livestock manures common to the state.

As indicated in Table 7, not all the nutrients in manure are available in the first year following application. For example with N, manure contains both organic and inorganic N—only the inorganic form is immediately available for crop uptake. The available N contribution to corn from dairy manure is approximately 30-35% of the total N content of the manure in the first crop year. Additional amounts of nutrients are added to the soil in the second and third year following manure applications. Detailed information on the second and third year manure nutrient credits can be found in USDA-Natural Resources Conservation Service *Wisconsin Field Office Technical Guide—Sec. IV, Spec. 590*.

Table 7. Average nutrient content from various manures.¹

	Animal Type ²			
	Dairy	Beef	Swine ³	Poultry
Total Nutrient Content				
Nitrogen (N)				
Solid (lbs/ton)	10	14	14	40
Liquid (lbs/1000 gal)	24	20	25	16
Phosphate (P₂O₅)				
Solid (lbs/ton)	5	9	10	50 ⁴
Liquid (lbs/1000 gal)	9	9	23	10
Potash (K₂O)				
Solid (lbs/ton)	9	11	9	30
Liquid (lbs/1000 gal)	20	20	22	12
First Year Availability				
Nitrogen (N)				
Solid (lbs/ton)				
<i>surface applied</i>	3	4	7	20
<i>incorporated</i>	4	5	9	24
Liquid (lbs/1000 gal)				
<i>surface applied</i>	7	5	13	8
<i>incorporated</i>	10	7	16	10
Phosphate (P₂O₅)				
Solid (lbs/ton)	3	5	6	30 ⁴
Liquid (lbs/1000 gal)	5	5	14	6
Potash (K₂O)				
Solid (lbs/ton)	7	9	7	24
Liquid (lbs/1000 gal)	16	16	18	10

¹ Values are rounded to the nearest pound.

² Assumes 24, 35, 20 and 60% dry matter for solid dairy, beef, swine and poultry manure, respectively. Assumes 6, 5, 3, and 3% dry matter for liquid dairy, beef, swine, and poultry manure respectively.

³ Assumes a farrow-nursery indoor pit operation for swine liquid manure nutrient values.

⁴ For turkey, use 40 lb/ton for total nutrient content and 24 lb/ton for first-year available nutrient content.

The Wisconsin soil test recommendations account for manure (and legume) nutrient credits when the appropriate field history information is provided with soil samples. The soil test report utilizes the standard nutrient credits from Table 7 unless specific manure analyses have been performed. For analyzed manure, 35 to 60% of the total N (depending on manure type), 55% of the total P_2O_5 , and 75% of the total K_2O should be credited in the first year. The fertilizer adjustment for analyzed manure needs to be made by the individual farmer, consultant, etc. For more information on the nutrient value of manure, see UWEX fact sheet A3411, *Manure Nutrient Credit Worksheet* or A3537, *Nitrogen Credits for Manure Applications*.

Management recommendations for minimizing the threat of manure nutrient losses to surface and groundwater are described in the manure management section of this publication.

Legumes

Legume crops, such as alfalfa, clover, soybeans, and leguminous vegetables, have the ability to fix atmospheric N and convert it to a plant-available form. When grown in a rotation, some legumes can supply substantial amounts of N to a subsequent corn crop. For example, a good stand of alfalfa can often provide all of the N needed for a corn crop following it in a rotation. An efficient nutrient management program needs to consider the N contribution of a legume to the next crop.

Table 8 lists the N credits currently recommended in Wisconsin for various legume crops. With forage legumes, stand density, soil texture, and cutting schedule affect the value of the N credit. Detailed information on legume-N crediting can be found in UWEX Publication A3517 *Using Legumes as a Nitrogen Source*.

Similar to the nutrient credits for manure applications, the Wisconsin soil test recommendations account for the

nutrient contributions from legumes, provided that rotation information is included with the soil samples submitted for testing.

Whey and Sewage Sludge

Application of organic wastes such as whey and sewage sludge is common in certain areas of the state; however, the overall percentage of corn acres treated with organic wastes is relatively small. Nonetheless, the nutrient contributions from sludge and whey applications are often significant and need to be credited. Special management and regulatory considerations pertain to the land application of these and other organic waste materials. Detailed information on the nutrient values and management practices associated with sludge and whey applications to agricultural lands is available in UWEX publications R2779, *Sewage Sludge Wastes that can be Resources*, and A3098, *Using Whey on Agricultural Land—A Disposal Alternative*.

Starter Fertilizer

A minimal amount of starter fertilizer is recommended for corn planted in soils slow to warm in the spring. For corn grown on medium and fine textured soils, a minimum application of 10 lb N, 20 lb P_2O_5 , and 20 lb K_2O per acre is recommended as a starter fertilizer at planting. In most corn fields, all the recommended P_2O_5 and K_2O can be applied as starter fertilizer. On soils with test levels in the excessively high range, starter fertilizer applications in excess of 10 lb N, 20 lb P_2O_5 , and 20 lb K_2O per acre should be avoided. Any amount of N applied as starter fertilizer that exceeds 20 lb N/acre should be credited against the overall N recommendation.



Table 8. Nitrogen credits for legume crops.

Legume Crop	N Credit	Exceptions
Forages		
<i>First Year Credit</i>		
Alfalfa	190 lb N/acre for a good stand ¹ 160 lb N/acre for a fair stand ¹ 130 lb N/acre for a poor stand ¹	Reduce credit by 50 lb N/a on sandy soils ² Reduce credit by 40 lb N/acre if less than 8 inches of regrowth at time of kill
Red clover	80% of alfalfa credit	Same as alfalfa
Birdsfoot trefoil	80% of alfalfa credit	Same as alfalfa
<i>Second Year Credit</i>		
Fair or good stand	50 lb N/acre	No credit on sandy soils ²
Green manure crops		
Sweet clover	80–120 lb N/acre	Use 20 lb N/acre credit if field has less than 6 inches of growth before tillage, killing frost, or herbicide application
Alfalfa	60–100 lb N/acre	
Red clover	50–80 lb N/acre	
Soybeans	credit of 40 lb N/acre	No credit on sandy soils ²
Leguminous vegetable crops		
Peas, snap beans and lima beans	20 lb N/acre	No credit on sandy soils ²

¹ A good stand of alfalfa (70–100% alfalfa) has more than 4 plants/ft²; a fair stand (30–70% alfalfa) has 1.5 to 4 plants/ft²; and a poor stand (< 30% alfalfa) has less than 1.5 plants/ft².

² Sandy soils are sands and loamy sands.

Timing of Applications



Timing of application is a major consideration in N fertilizer management. The period between N application and corn uptake is an important factor affecting the efficient utilization of N by the crop and the amount of nitrate-N lost through leaching or other processes. Obviously, loss of N can be minimized by supplying it just prior to the period of greatest uptake by corn. In Wisconsin this typically occurs in mid-June throughout July when corn is in a rapid growth and dry matter accumulation period. Applications at such times reduce the potential for N to leach from the root zone before plant uptake can occur. On sandy soils, this kind of timely application is essential. On medium and finer textured soils, N leaching losses during the growing season are significantly less. Other factors including soil, equipment, and labor, are involved in determining the most convenient, economical, and environmentally safe N fertilizer application period for corn.

In regards to P fertilizer management, application timing is not a major factor affecting water quality protection. However, applications of P on frozen sloping soils or applications just prior to likely runoff events should be avoided to prevent P contributions to surface waters.

Fall Versus Spring N Applications

The advantages and disadvantages of fall N fertilizer applications have been discussed for many years. An increased risk of N loss during the fall and early spring needs to be weighed against the price and convenience advantages often associated with fall-applied N. The agronomic concern with fall N applications is that losses between application and uptake the following growing season will lower crop recovery of N and reduce corn yield. The environmental concern with fall application is that the N lost prior to crop uptake will leach into groundwater.

Fall to spring precipitation, soil texture, and soil moisture conditions influence the potential for fall-applied N losses. As a result, the relative effectiveness of fall N applications varies widely from one year to the next depending on climatic conditions. If a soil is wet in the fall, rain-fall may cause either leaching of nitrate in coarse soils or denitrification of nitrate in heavy, poorly drained soils. Long-term studies indicate that fall applications are usually less

effective than spring applications. Wisconsin research has shown fall applications on medium textured soils to be 10 to 15% less effective than the same amount of N applied spring preplant.

For both agronomic and environmental reasons, fall applications of N fertilizers are not recommended on coarse textured soils or on shallow soils over fractured bedrock. If fall applications are to be made on other soils, they should be limited to the application of only the ammonium forms of N (anhydrous ammonia, urea, and ammonium sulfate) on medium textured, well-drained soils where N losses through leaching or denitrification are usually low. Fall applications of N should also be delayed until soil temperatures are less than 50° F in order to slow the conversion of ammonium to nitrate by soil organisms. If fall applications must be made when soil temperatures are higher than 50° F, a nitrification inhibitor should be used. Studies have shown that nitrification inhibitors are effective in delaying the conversion of ammonium to nitrate when N is fall-applied. However, fall applications of N with an inhibitor are still not likely to be as effective as spring-applied N.

Preplant N Applications

Spring preplant applications of N are usually agronomically and environmentally efficient on medium-textured, well drained soils. The potential for N loss prior to corn uptake on these soils is relatively low with spring applications. If spring preplant applications of N are to be made on sandy soils, ammonium forms of N treated with a nitrification inhibitor should be used. Likewise, nitrification inhibitors

Table 9. Probability of corn yield response with sidedress versus preplant N application.

Soil	Relative Probability
Sands & loamy sands	Good
Sandy loams & loams	Fair
Silt loams & clay loams:	
– well-drained	Poor
– poorly drained	Fair

should be used if spring preplant N is applied to poorly drained soils. Use of nitrification inhibitors reduces the potential for N loss compared to preplant applications without them; however, sidedress or split applications are usually more effective than preplant applications with nitrification inhibitors.

Sidedress N Applications

Sidedress applications of N during the growing season are effective on all soils with the greatest benefit on sandy or heavy textured-poorly drained soils (Table 9). The efficiency of sidedress N applications can be attributed to the application of N just prior to the period of rapid N uptake by corn and a much shorter period of exposure to leaching or denitrification risks. Table 10 illustrates the higher yield

Table 10. Effect of rate and time of N application on corn yield and recovery of applied N on sandy, irrigated soil. Hancock, Wisconsin, 1981–84.

N Rate --- (lb/a) ---	Yield		N Recovery	
	Preplant	Sidedress ¹	Preplant	Sidedress
	----- (bu/a) -----		----- (%) -----	
0	38	38	—	—
70	88	105	50	73
140	120	136	44	64
210	132	143	40	49
Average	113	128	45	62

¹ Sidedress treatments applied six weeks after planting.



and crop recovery of N on sandy soils with sidedress applications. In these trials, use of sidedress N applications improved average N recovery over preplant applications by 17%. The use of sidedress or delayed N applications on sandy soils is essential for minimizing N loss to groundwater since unrecovered N on these soils will be lost through leaching. Sidedress N applications may also be of benefit on shallow soils over fractured bedrock.

Sidedressing N requires more management than preplant N applications. In order to maximize efficiency, sidedress N applications must be properly timed to provide available N during the maximum N-uptake period for corn which begins at about 6 weeks after planting and continues for an additional 4 to 6 weeks. Applications too late may result in lower yield and plant injury from root pruning and other physical damage.

Split or Multiple N Applications

Application of N fertilizer in several increments during the growing season can be an effective method for reducing N losses on sandy soils. However, a single well-timed sidedress application is often as effective as multiple applications. Ideally, split applications supply N when needed by the corn and allow for N application adjustments based on early growing season weather or plant and soil tests.

Where split or multiple applications are used, any preplant N additions should be minimized and most of the N should be applied just prior to expected crop use.

To be successful, the timing of application and placement of fertilizer materials are critical. Climatic factors, such as untimely rainfalls, may interfere with application schedules and could result in nutrient deficiencies. Split applications, as well as sidedress applications, also tend to be more time, labor, energy and equipment intensive than preplant N applications.

Fertigation

A common method for split or multiple N applications is via irrigation systems. Multiple applications of fertilizer N at relatively low rates (30-50 lb N/a) can be injected into the irrigation water and applied to correspond with periods of maximum plant uptake. Theoretically, this should make less N available for loss through leaching. The most common fertilizer applied in irrigation systems is 28% N solution because it is readily available and causes little or no equipment problems during injection to irrigation water. Anhydrous ammonia should not be used in sprinkler irrigation systems because it can cause precipitation of calcium in the water and loss of free ammonia to the atmosphere.

The success of fertigation systems is dependent on climatic factors and proper management. Fertigation should not be relied upon as a sole method of applying N in a cropping season for the following reasons:

- ❑ Adequate rainfall during the early growing season could delay or eliminate the need for irrigation water. A delay in fertilizer application could reduce yields dramatically.
- ❑ Leaching can result if N is applied through an irrigation system at a time when the crop does not need additional water.
- ❑ All N applications need to be made prior to the crop's period of major N uptake. If applied later, little of the applied N will be used and leaching potential will be increased.

It also needs to be noted that the potential for back-siphoning of N into the well exists with fertigation. Wisconsin law requires anti-siphoning check valves to be in place on irrigation systems; however, if the guards are not properly installed, maintained, or not in place at all, fertigation systems could directly contribute to groundwater contamination.

Nitrification Inhibitors

Nitrification inhibitors are used with ammonium or ammonium-forming N fertilizers to improve N efficiency

Table 11. Relative probability of increasing corn yield by using nitrification inhibitors.

Soil	Time of N Application	
	Fall	Spring Preplant
Sands & loamy sands	— ¹	Good
Sandy loams & loams	Fair	Good
Silt loams & clay loams		
– well-drained	Fair	Poor
– somewhat poorly drained	Good	Fair
– poorly drained	Good	Good

¹ Fall applications not recommended on these soils.

Note: Likelihood of response to inhibitor with spring sidedress N applications is poor.

Table 12. Effects of nitrification inhibitor on corn yield and recovery of applied N, Hancock, Wisconsin, 1982–84.

N-Serve Rate	Yield ¹	N Recovery
(lb/a)	(bu/a)	(%)
0	87	29
0.5	99	43

¹ Average of three N rates (70, 140, 210 lb/N/a).

and limit losses of fertilizer N on soils where the potential for nitrate leaching or denitrification is high. Nitrification inhibitors function by slowing the conversion of ammonium to nitrate, thereby reducing the potential for losses of N that occur in the nitrate form. At this time nitrapyrin (N-Serve) is the only nitrification inhibitor registered for use in Wisconsin.

The effectiveness of a nitrification inhibitor depends greatly on soil type, time of the year applied, N application rate and soil moisture conditions that exist between the time of application and the time of N uptake by plants. Table 11 gives relative probabilities for obtaining a corn yield increase when using a nitrification inhibitor in Wisconsin based on soil type and time of application.

Research has shown that the application of nitrification inhibitors on coarse textured, irrigated soils has the potential to increase corn yield and total crop recovery of N (Table 12). It should be noted that responses to inhibitor use on coarse-textured soils usually occur with spring preplant N applications. However, fall applications of N with an inhibitor on coarse textured soils are not recommended because the present inhibitors do not adequately control nitrification on these soils over such an extended period of time. As indicated previously, sidedress N applications are likely to be more effective on these soils. It is unlikely that sidedress applications of N will benefit from the use of a nitrification inhibitor due to the short period between application and uptake. Nitrification inhibitors have been shown to give a positive response on corn yield when used with fall or spring preplant N applications on heavy textured, poorly drained soils.

Careful management of N fertilizers even with the use of a nitrification inhibitor is required. Nitrapyrin is volatile and requires immediate incorporation. Also, fall applications of N when soil temperatures are above 50° F may result in accelerated degradation of the inhibitor which will reduce the potential for improved N recoveries.

Soil Nutrient Placement

Placement of soil nutrients on agricultural fields can be a factor in determining their potential to affect water quality. Nutrient placement is a more important consideration with respect to P management and surface water quality protection than with N and groundwater quality.

Nitrogen

The concern with N placement focuses more on preventing N loss through ammonia volatilization than movement to groundwater. Applications of N in the form of urea or N solutions need to be incorporated by rainfall, irrigation, injection or tillage. The amount of volatilization that occurs with surface N applications depends on factors such as soil pH, temperature, moisture, and crop residue cover. Minimal volatilization losses of N can be expected if spring surface applications are incorporated within 3 to 4 days—provided temperatures are low (<50°F) and the soil is moist. However, a late spring or summer application should be incorporated within a day or two because higher temperatures and the chance of longer periods without rainfall could lead to significant N volatilization losses. Recent research shows that losses may be as high as 20% under these conditions.

Phosphorus

The placement of P-containing materials directly influences the amount of P transported to lakes and streams by surface runoff. If P inputs are broadcast on the soil surface and not incorporated, P levels of runoff waters can rise sharply. Phosphorus is strongly bound to soil particles; however, adequate soil-P contact must occur to allow for adsorption. Incorporation by tillage or subsurface band placement is a very effective means of achieving this contact. Wisconsin studies have shown that eroded sediment and runoff from soil surfaces where P fertilizer was not incorporated will contribute significantly higher amounts of P to runoff and have a greater potential for impact on surface water quality than from soil surfaces where P was incorporated.

To avoid enriching surface waters with soil nutrients, it is recommended that annual fertilizer applications for corn be band-applied near the row as starter fertilizer at planting. Annual starter applications of P can usually supply all of the P required for corn. This practice reduces the chance for P enrichment of the soil surface and reduces P loads in runoff from cropland. In addition, research has shown row applications of starter fertilizer can increase corn yields on most soils. Band fertilizer placement should be 2 inches to the side and 2 inches below the seed. Rates of application should be monitored closely if placement is closer to the seed.

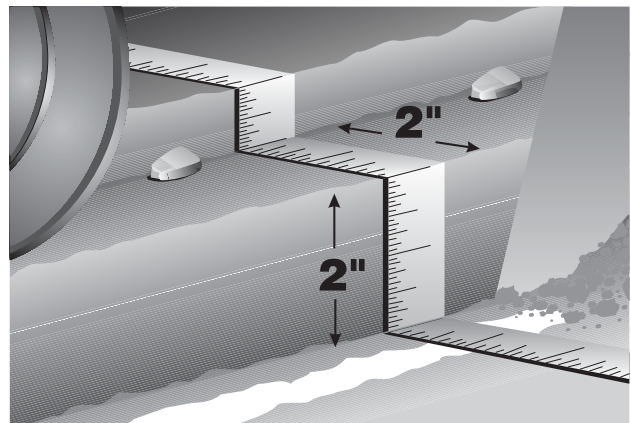

When large broadcast P fertilizer applications are needed to increase low soil P levels, these applications should always be followed by incorporation as soon as possible.

Manure Management

Manure is a valuable resource. Manure applications to cropland provide nutrients essential for crop growth, add organic matter to soil, and improve soil structure, tilth, and water holding capacity. As with other nutrient sources, improper use of manure can result in environmental damage. The major concerns associated with manure applications are related to its effects on surface and groundwater quality. In regards to groundwater, the nitrate-N contribution of manure is of greatest concern. The likelihood of nitrate reaching groundwater is increased if manure applications exceed crop N needs, N contributions to soil from manure applications are not credited in fertilizer recommendations, or manure is improperly stored or handled. With surface waters, P is the manure nutrient of importance. Runoff from manured fields can carry readily available soil nutrients to surface waters. The high soluble P content of manure can have immediate adverse effects on surface water quality by enhancing production of algae and aquatic plants, and decreasing dissolved oxygen levels.

Application Methods

Proper manure application techniques are very important for reducing contributions of P to surface waters. Agronomically, proper application of manure is important in preventing losses of N through the volatilization of ammo-

nia. Both nutrients can be conserved by incorporating or injecting manure. To protect surface water quality and reduce volatilization losses, it is recommended that surface-spread manure be incorporated within three days of application. Incorporation should reduce nutrient loss provided the tillage is sufficiently deep and does not accelerate soil loss. If a reduction in soil erosion protection appears likely from the incorporation of manure on sloping lands, a form of reduced tillage should be used. All incorporation or injection should follow the land contour when possible. When the incorporation or injection of manure is not practical, manure spreading should be directed to fields that have runoff control practices in place and which do not discharge unfiltered runoff to streams and lakes.

Application Rates

Two common strategies for manure application to cropland exist:

- a P management strategy, and
- a N management strategy.

If maximum nutrient efficiency is the goal, rates of manure application need to be based on the nutrient present at the highest level relative to crop needs. For corn, the nu-



trient is P. With this strategy, manure should be applied at a rate which will meet corn's requirement for P; additional N and potassium (K) are supplied from other nutrient sources as needed. A management strategy based on P dictates the lowest manure application rates but it is the least likely to result in degradation of water quality. It has the disadvantages of being inefficient with respect to labor, energy, and time, more costly, and may have limited practicality. This system is only possible where the farmer has adequate land to spread manure at the lower rates required for this strategy.

An alternative strategy for utilizing manure is to determine a rate of application which will fulfill the corn requirement for N. This strategy maximizes the rate of application but results in the addition of P and K in excess of corn nutrient needs. The N strategy is most commonly used since the amount of land available for application is often limited. While other environmental considerations may restrict the timing, location, and methods of application, corn N requirements are the major rationale for limiting rates with this method of utilization. The amount of available N in manure and soil can be determined by manure and soil analysis. In lieu of specific manure analysis, estimates of the amount of available nutrients from manure are given in Table 7.

A manure application strategy based on crop N requirement will lead to an accumulation of P with repeated applications. Excessive soil test levels of P can result in surface water quality problems in the event of runoff and soil erosion. When soil test levels for P reach **75 ppm**, manure applications should be reduced and P-demanding crops such as alfalfa planted. At P soil test levels of **150 ppm**, manure and other sources of P should be discontinued until soil test

levels decrease. Soil runoff and erosion control practices such as residue management, conservation tillage, contour farming and filter strips are strongly recommended on soils where P levels significantly exceed crop needs.

From strictly a water quality viewpoint, P soil test levels of 75 to 150 ppm may be too high for some agricultural sites. Soil test P levels lower than 75 ppm would significantly reduce threats to surface water quality and be adequate for most crop needs. However, with the average P soil test level of Wisconsin soils at approximately 46 ppm and P soil test levels from dairy operations approximately twice that level, a P soil test limit of 75 ppm is not realistic for livestock operations needing to dispose of animal waste. Additionally, a statewide recommendation limiting soil test levels at 75 ppm would fail to consider the diversity of the state's soils. For example, areas of sandy soils where the potential for runoff and water erosion is low, higher P soil test levels would most likely not pose a threat to surface water quality. A general recommendation for P soil test levels would be that in the absence of adequate runoff control and soil conservation practices on soils susceptible to runoff and erosion, P soil test levels of 75 ppm should not be exceeded.

For surface water quality protection, it is recommended that on fields where manure cannot be incorporated, no more than 25 tons/acre of solid dairy manure or its equivalent based on P content be applied annually. In long term cropping situations that preclude manure incorporation (i.e. continuous no-till corn) it is recommended that a cumulative total of not more than 25 tons/acre of solid dairy manure (or its equivalent in P-content) be applied over a 5-year period unless previously applied manure has been incorporated.



Application Timing

Manure application timing is of greater concern in controlling P contributions to surface waters than nitrate movement to groundwater. Manure should not be spread on sloping lands any time a runoff producing event is likely. Unfortunately, runoff producing events are impossible to predict and the elimination of manure applications to sloping lands is seldom a practical consideration for landowners. The period of major concern is the late fall, winter, and early spring months. Manure applied on frozen ground has an increased likelihood for contributing nutrients to surface waters due to spring thaws and rains causing runoff.

If winter applications of manure must be made, the risk should be minimized to the greatest extent possible. Manure applications to frozen soils should be limited to slopes of less than 6%. Preferably these soils are cornstalk covered, roughly tilled, or protected from up-slope runoff.

If applications of manure to frozen soils with slopes of 6 to 12% must be made, conservation measures need to be in place in order to protect surface waters. Grassed waterways must be well-established and maintained. Terraces should be in place, if appropriate, or fields contoured and strip-cropped with alternate strips in sod. If fields are farmed on the contour, they should be protected with an adequate residue cover from the previous year's crop.

Manure should not be applied to frozen soils on slopes greater than 12%.

Site Considerations

Most soils have a high capacity for assimilating nutrients from waste materials such as manure. Unfortunately, areas of the state exist where the soil is highly permeable or shallow over fractured bedrock. In such areas, groundwater problems from the application of manure can result. For shallow soils, manure should not be applied to soils less than 10 inches thick over fractured bedrock. Where soil cover is 10 to 20 inches thick, manure needs to be incorporated within three days of application to allow for maximum soil adsorption of nutrients. Manure should not be applied when these soils are frozen. The 10 to 20 inch recommendation is intended for livestock operations in limited areas of the state where such unique soil conditions exist.

Movement of mobile nutrients to groundwater is more likely on excessively drained (sandy) soils. Manure applications in early fall to fields where no actively growing crop is present to utilize the N, may allow for the conversion of organic N to nitrate which is then subject to movement by

leaching. Whenever possible, manure should not be applied to sands or loamy sands in the fall when soil temperatures are greater than 50° F (conversion of ammonium-N to nitrate-N is significantly reduced at soil temperatures below 50° F) unless there is an over-wintering cover crop present to utilize the N. In the absence of a cover crop, apply manure when soil temperatures are below 50° F.

The main site characteristics affecting nutrient contributions to surface waters are those that affect soil runoff and erosion. These include slope, soil erodibility and infiltration characteristics, rainfall, cropping system and the presence of soil conservation practices. Site related management practices dealing specifically with manure placement to protect surface water include:

- ❑ Do not apply manure within a 10-year floodplain or within 200 feet of lakes and streams unless incorporation follows as soon as possible—no later than 72 hours after application. Do not apply manure to frozen soils in these areas. The 200 foot set-back allows for buffer strips to slow runoff velocity and deposit nutrient and sediment loads. Do not apply manure to the soils associated with these land areas when they are saturated.
- ❑ Do not apply manure to grassed waterways, terrace channels, open surface drains or other areas where surface flow may concentrate.

Manure Storage

During periods when suitable sites for land application of manure are not available (i.e., soils are frozen or seasonally saturated), the use of manure storage facilities is recommended. Storage facilities allow manure to be stored until conditions permit land application and incorporation. In addition, storage facilities can minimize nutrient losses resulting from volatilization of ammonia and be more convenient for calibrated land applications. With the exception of those systems designed to filter leachate, storage systems should retain liquid manure and prevent runoff from precipitation on stored waste. It is imperative that manure storage facilities be located and constructed such that the risk of direct seepage to groundwater is minimized. With regards to maximum nutrient efficiency and water quality protection, it is critical that appropriate application techniques and accurate nutrient credits of the manure resource are utilized when the storage facility is emptied.

Irrigation Management



Irrigation has become a standard agricultural practice in the sandy regions of Wisconsin and in other areas where shallow groundwater is available. As a result corn production on these often droughty soils has been successful; however, water quality problems may be increasing. Over-irrigation or rainfall on recently irrigated soils can leach nitrate and other contaminants below the root zone and into groundwater. Irrigation systems management is an important practice to consider in protecting the quality of groundwater.

The N management practices previously described will not, by themselves, effectively reduce leaching on soils that are regularly over-irrigated. Excess water from irrigation or precipitation can cause nitrate movement below the root zone. Accurate irrigation scheduling during the growing season can reduce the risk of leaching losses. A good irrigation scheduling program that considers soil water holding capacity, crop growth stage, evapotranspiration, rainfall and previous irrigation in order to determine the timing and amount of irrigation water to be applied is essential. Irrigation amounts adequate to meet crop needs but less than

the amount needed to saturate the soil profile will allow for rainfall to occur without causing leaching or runoff.

To promote irrigation efficiency, the University of Wisconsin-Extension has implemented the Wisconsin Irrigation Scheduling Program (WISP). WISP uses a water budget approach to advise growers on appropriate irrigation frequencies and amounts. Parameters included in the program include those mentioned above. The program allows flexibility in irrigation scheduling due to variations in weather. Further information on WISP can be found in UWEX publication A3600, *Irrigation Management in Wisconsin—the Wisconsin Irrigation Scheduling Program (WISP)*.

Soil Conservation



Land-use activities associated with modern agriculture can increase the susceptibility for runoff and sediment transport from cropland fields to surface waters. Consequences of cropland erosion include loss of fertile topsoil, accelerated eutrophication and sedimentation of surface waters, destruction of fish and wildlife habitat, and decreased recreational and aesthetic value of surface waters.

The key to minimizing nutrient contributions to surface waters is to reduce the amount of runoff and eroded sediment reaching them. Numerous management practices for the control of runoff and soil erosion have been researched, developed, and implemented. Runoff and erosion control practices range from changes in agricultural land management (cover crops, diverse rotations, conservation tillage, contour farming, contour strip cropping, etc.) to the installation of structural devices (diversions, grade stabilization structures, grassed waterways, terraces, etc.). These practices are effective in reducing contaminant transport to surface waters.

Despite the proven effectiveness of soil conservation practices in reducing nutrient loadings to surface waters, their effect on groundwater quality is unknown. Practices that reduce surface runoff by increasing soil infiltration may, in turn, enhance the movement of soluble agricultural chemicals through the soil profile to groundwater. Trade-offs between reducing runoff and protecting groundwater quality may exist. If such is the case, decisions weighing the impact of one resource versus another will need to be made. Research on the effects of soil conservation management practices on groundwater quality is limited and often contradictory. It is clear that these relationships require further investigation.

Crop Rotation and Selection

The selection of crops to include in a rotation with corn has been shown to influence the movement of N through soil profiles and the transport of P to surface waters. Legumes and other crops that do not require supplemental N inputs can effectively “scavenge” N remaining in the soil from previous crops. Also, crops with low N fertilizer requirements used in sequence with crops that require high N inputs or inefficiently recover N can reduce the amount of N inputs applied over a number of years. On soils with excessively high P levels, including a P-demanding crop such as alfalfa in the rotation would help to draw down P levels, as well as reduce soil and runoff losses and P losses to nearby surface waters.

Legumes used in cropping rotations fix atmospheric N and serve as an organic source of N. However, legumes will utilize residual inorganic N from the soil in preference

to fixing N. Deeply rooted legumes such as alfalfa often utilize soil N located below the rooting depths of other crops such as corn. Alfalfa has the potential to root to depths greater than 18 feet and research has shown that nitrate is utilized by alfalfa from any depth where soil solution is extracted by its roots. The use of alfalfa in rotations appears to be a viable management alternative for removing nitrate from soils below the rooting depth of most crops.

The removal of subsoil nitrates by deeply rooted legumes such as alfalfa would most likely be of more significance on medium and heavy textured soils than on sands. Research has shown that N applied to sandy soils that is not utilized by the crop is often leached below rooting depths in less than one year. Thus, alfalfa following corn in a rotation on sandy soils will not be able to recover nitrate which has previously passed through the profile.

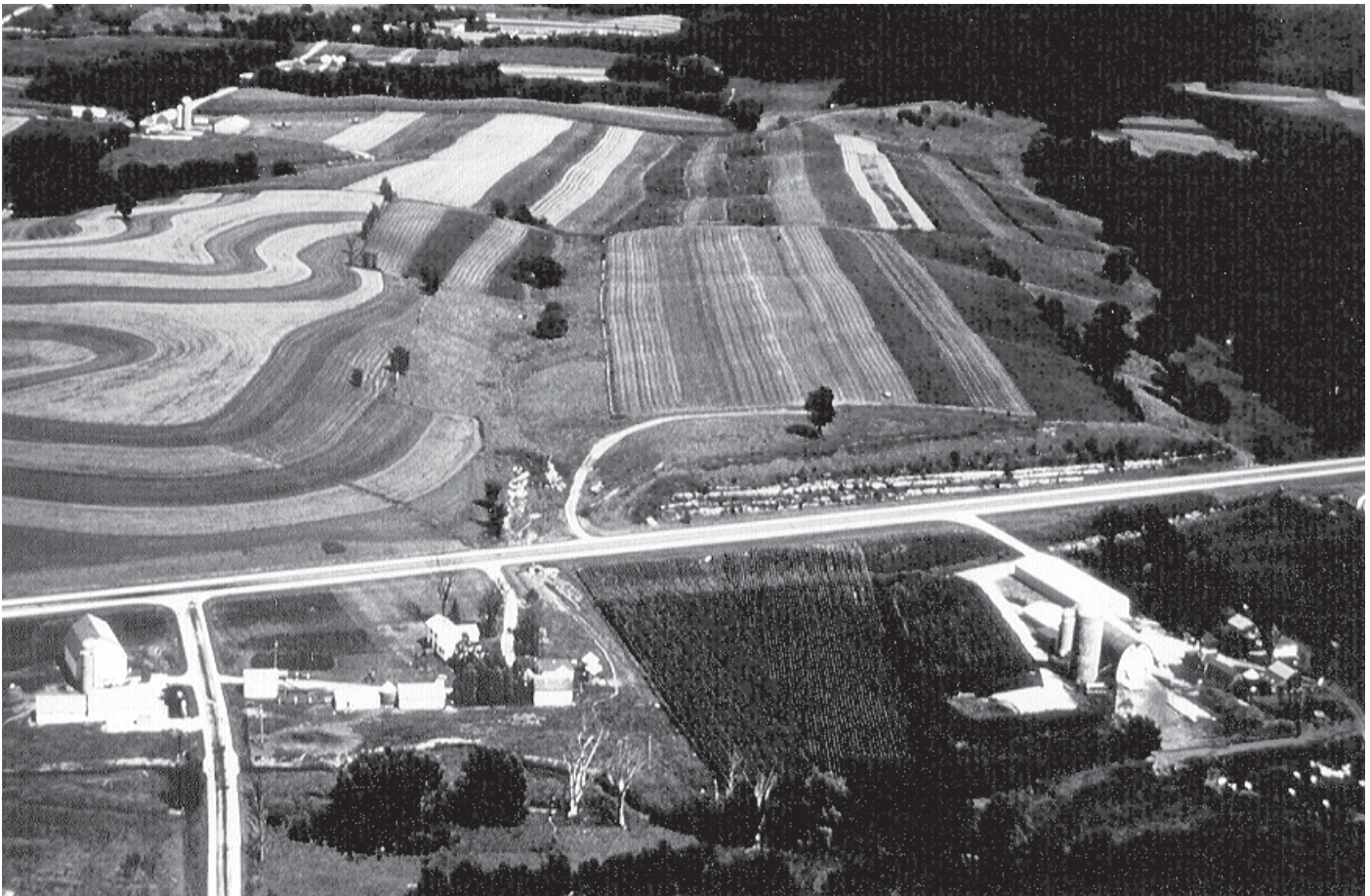

Filter Strips



Maintaining or establishing strips of close-growing vegetation adjacent to water bodies is a practice that can reduce the sediment and nutrient content of runoff waters reaching them. The velocity of runoff is reduced when passing through a buffer strip as is its capacity for transporting sediment and nutrients. Sediment is deposited and runoff infiltrates or passes through the buffer strip with a substantially reduced nutrient content.

The width of an effective buffer strip varies with land slope, type of vegetative cover, watershed area, etc. Buffer strip dimensions need to be specifically designed for given field and cropping conditions. Local Land Conservation Department or Soil Conservation Service staff can assist landowners in establishing buffer strips.

Although proven effective in improving surface water quality, buffer strips may potentially have an adverse effect on groundwater quality. Increased infiltration in an area of sediment deposition may promote the leaching of soluble contaminants such as nitrate. The extent to which this may occur needs to be investigated and evaluated against the benefits to surface water quality.

Conservation Tillage

Conservation Tillage and Fertilizers

Conservation or reduced tillage systems, while being very effective in reducing runoff and soil erosion, require some degree of specialized nutrient management. This is particularly true for no-till systems of corn production. Research evaluating the effect of conservation tillage systems on nitrate movement to groundwater is limited. However, from a corn production standpoint, it is recommended that in addition to the standard N recommendation, an additional 30 lbs/acre of N be applied to continuous no-till and ridge-till corn production systems where residue cover after planting is at least 50%. This is needed to offset N that may be immobilized in surface residues and the lower annual amount of N mineralized from soil organic matter in high residue systems.

A great deal of research has investigated the effects of conservation tillage systems on P losses to surface waters. Recommended production practices for conservation tillage in Wisconsin fit well with surface water quality objectives. It has always been recommended that required fertilizer and lime be broadcast and incorporated prior to the implementation of a conservation tillage system. Annual fertilizer additions should be band-applied once the conservation tillage system is established.

Conservation Tillage and Manure

Effective handling of manure is very important in protecting water quality. As mentioned earlier, nutrient additions to surface waters can be significantly reduced if land applied manure is incorporated. This is possible with most forms of reduced tillage but obviously not in no-till systems.

For both water quality and crop production purposes, manure applications to no-till cropland are not recommended. Research has shown that the P loadings to surface waters from manured no-till cropland can be extremely high. In addition, serious production problems can result from

the application of manure to no-till fields. A colder and wetter soil environment is created which can delay seed germination and the early growth of crops. Weed problems may also increase due to manure reducing herbicide activity and contributing weed seeds to the soil. Manure and the associated higher soil moisture content can also produce mechanical problems for planting equipment. Any or all of these conditions can cause serious production problems and reduce yields.

The problems presented with manure applications to no-till fields can be alleviated with light incorporation. After applications to no-till fields, manure should be lightly disked into the first two inches of soil. This will allow P to interact with soil particles and should reduce P contributions to runoff. In addition, the disking distributes manure more evenly and reduces the mechanical and soil temperature problems. This practice should not sacrifice erosion control because sufficient surface residues should still remain. While no longer strictly no-till, this modified practice is necessary to integrate the benefits of no-till and manure application.

Regardless of tillage, the practice of injecting manure at recommended rates with proper techniques can remove potential threats to surface water quality. Injection places soluble P in manure below the soil surface and maintains sufficient surface residue for runoff and soil erosion control in conservation tillage systems.



Conclusion

This publication provides a brief summary of general nutrient management practices for Wisconsin corn production. It is not a complete inventory but rather an overview of soil fertility management options available to corn growers for improving farm profitability and protecting water quality. The selection of appropriate nutrient management practices for individual farms needs to be tailored to the specific conditions existing at a site.

Additional information on the topics discussed in this publication is available. Consult the following reference list for other publications on soil nutrient management practices. Advice on the applicability of these practices to individual farming situations can be gained from local University of Wisconsin–Cooperative Extension Service staff.



References

- Bundy, L.G. 1985. Corn fertilization. Univ. Wis. Coop. Extn. Ser. Bull. No. A3340.
- Bundy, L.G. 1985. Understanding plant nutrients: soil and applied nitrogen. Univ. Wis. Coop. Extn. Serv. Bull. No. A2519.
- Bundy, L.G. 1987. Nitrogen management for groundwater protection and efficient crop use. Proceedings of 1987 Wis. Fert., Aglime & Pest Mgmt. Conf. 26:254-262.
- Bundy, L.G. 1988. Estimating nitrogen availability from soil and plant tests. Proc. 1988 Wis. Fert., Aglime & Pest Mgmt. Conf. 27:319-325.
- Bundy, L.G. 1989. Nitrogen management to protect groundwater resources. Ag Chem. Mgmt. Univ. Wis. Coop. Extn. Ser. Inservice Handbook.
- Bundy, L.G. 1989. The new Wisconsin nitrogen recommendations. Proc. Wis. Area Fert. and Aglime Dealer Meetings, Nov. 28 - Dec. 14, 1989.
- Bundy, L.G., T.W. Andraski, and P.C. Widen. Soil nitrate test results and corn N responses in 1989. Dept. of Soil Sci., Univ. Wis.-Madison. Mimeo.
- Bundy, L.G., K.A. Kelling, and L. Ward Good. 1990. Using legumes as a nitrogen source. Univ. Wis. Coop. Extn. Ser. Bull. No. A3517.
- Bundy, L.G., and E.S. Malone. 1988. Effect of residual profile nitrate on corn response to applied nitrogen. Soil Sci. Soc. Am. J. 52:1377-1383.
- Bundy, L.G., S.J. Sturgul, and K.A. Binning. 1994. Soil nitrate tests for Wisconsin cropping systems: A guide for using the preplant and pre-sidedress soil nitrate tests. Univ. Wis. Coop. Extn. Serv. Bull. No. A3624.
- Bundy, L.G., S.J. Sturgul, and R.W. Schmidt. 1990. Wisconsin's preplant soil profile nitrate test. Univ. Wis. Coop. Extn. Ser. Bull. No. A3512.
- Combs, S.M., E.E. Schulte, and L.G. Bundy. 1989. Summary of 1989 soil nitrate test results and outlook for 1990. Proc. 1989 Wis. Fert., Aglime, and Pest Mgmt. Conf.
- Council for Agricultural Science and Technology (CAST). 1985. Agriculture and groundwater quality. CAST Report No. 103. May, 1985.
- Curwin, D., and L.R. Massie. 1994. Irrigation management in Wisconsin-the Wisconsin irrigation scheduling program (WISP). Univ. Wis. Coop. Extn. Serv. Bull. No. A3600.
- Daniel, T.C., D.H. Mueller, B.J. Andraski, and R.E. Springman. 1989. Effect of tillage on erosion and runoff water quality. Univ. Wis. Coop. Extn. Serv. Bull. No. G3432.
- Daniel, T.C., R.C. Wendt, and F.W. Madison. 1979. Nonpoint pollution: sediment and phosphorus in agricultural runoff. Univ. Wis. Coop. Extn. Serv. Bull. No. G2966.
- Keeney, D.R., T.C. Daniel, and B. Shaw. 1986. Nitrate in Wisconsin groundwater: sources and concerns. Univ. Wis. Coop. Extn. Serv. Bull. No. G3054.
- Kelling, K.A., and A.E. Peterson. 1981. Using whey on agricultural land - a disposal alternative. Univ. Wis. Coop. Extn. Serv. Bull. No. A3098.
- Kelling, K.A., E.E. Schulte, L.G. Bundy, S.M. Combs, and J.B. Peters. The new Wisconsin soil test recommendation program: Vegetables. Proc. Processing Crops Conf. 20-22 Feb, 1990. LaCrosse, WI.
- Kelling, K.A., E.E. Schulte, L.G. Bundy, S.M. Combs, and J.B. Peters. The new Wisconsin soil test recommendation program: Forages. Proc. WI Forage Council Symp. 1990.
- Kelling, K.A., E.E. Schulte, L.G. Bundy, S.M. Combs, and J.B. Peters. 1991. Soil test recommendations for field, vegetable, and fruit crops. Univ. Wis. Coop. Extn. Ser. Bull. No. A2809.
- Hendrickson, L.L., D.R. Keeney, and L.M. Walsh. 1978. Evaluation of nitrapyrin as a means of improving nitrogen efficiency in irrigated sands. Agron. J. 70:689-703.
- Hendrickson, L.L., L.M. Walsh, and D.R. Keeney. 1978. Effectiveness of nitrapyrin in controlling nitrification of fall and spring applied anhydrous ammonia. Agron. J. 70:704-708.

- Jackson, G., D. Keeney, D. Curwen, and B. Webendorfer. 1987. Agricultural practices to minimize groundwater contamination. Univ. Wis. Coop. Extn Serv. 115p.
- Leclerc, S. 1987. Effects of residual profile nitrate accumulation on corn response to applied N. M.S. Thesis. Dept. of Soil Sci., Univ. Wis.-Madison.
- Madison, F., K.A. Kelling, J. Peterson, T.C. Daniel, G. Jackson, and L. Massie. 1986. Managing manure and waste: guidelines for applying manure to pasture and cropland in Wisconsin. Univ. Wis. Coop. Extn. Serv. Bull. No. A3392.
- Magdoff, F.R., D. Ross, and J. Amadon. 1984. A soil test for nitrogen availability to corn. Soil Sci. Soc. Am. J. 48:1301-1304.
- Mathers, A.C., B.A. Stewart, and B. Blair. 1975. Nitrate-N from soil profiles by alfalfa. J. Environ. Qual. 4:403-405.
- Mueller, D.H., T.C. Daniel, and R.C. Wendt. 1981. Conservation tillage: best management practice for nonpoint runoff. Environ. Mgmt. 5(1):33-53.
- Mueller, D.H., R.C. Wendt, and T.C. Daniel. 1984. Phosphorus losses as affected by tillage and manure application. Soil Sci. Soc. Am. J. 48:901-905.
- Olsen, R.J., R.F. Hensler, O.J. Attoe, S.A. Witzel, and L.A. Peterson. 1970. Fertilizer nitrogen and crop rotation in relation to movement of nitrate-N through soil profiles. Soil Sci. Soc. Am. Proc. 34:448-452.
- Schulte, E.E., and A.E. Peterson. 1988. Using cover crops in sustainable agriculture. Dept. of Soil Sci., Univ. Wis.-Madison.
- Schulte, E.E., and L.M. Walsh. 1993. Management of Wisconsin soils. 4th ed. Univ. Wis. Coop. Extn. Ser. Bull. No. A3588
- Stewart, B.A., F.G. Viets, and G.L. Hutchinson. 1968. Agriculture's effect on nitrate pollution of groundwater. J. Soil Water Cons. 23:13-15.
- USDA-Soil Conservation Service. 1991. Wisconsin field office technical guide, Sec. IV-Spec. 590.
- Ward Good, L., F.W. Madison, K. Cates, and K.A. Kelling. 1991. Nitrogen credits for manure applications. Univ. Wis. Coop. Extn. Ser. Bull. No. A3537.
- Wis. Dept. Ag., Trade & Cons. Protection. 1989. Nutrient and pesticide best management practices for Wisconsin farms. WDATCP Tech. Bull. 1 - Univ. Wis. Coop. Extn. Ser. Bull. No. A3466.

Authors: Larry G. Bundy, Keith A. Kelling and Emmett E. Schulte are professors of soil science, University of Wisconsin-Madison and extension soil scientists, University of Wisconsin-Extension. Sherry Combs is director of the Soil and Plant Analysis Laboratory, University of Wisconsin-Extension. Richard P. Wolkowski is an outreach program manager in the Department of Soil Science, University of Wisconsin-Extension. Scott J. Sturgul is a senior outreach specialist with the Nutrient and Pest Management Program, University of Wisconsin-Madison. Desktop publishing: Kimberly Binning is an editor and Roger Schmidt is an information processing consultant with the Nutrient and Pest Management Program, University of Wisconsin-Madison.

Partial funding provided by the Wisconsin Department of Natural Resources - Nonpoint Source Priority Watershed Program.

This Publication is available from your Wisconsin County Extension office or from: Extension Publications, Cooperative Extension Publications, 45 N. Charter Street, Madison WI 53715. Phone (608) 262-3346 or (877) 947-7827 Contact Extension Publications to determine availability before publicizing.

An EEO/Affirmative Action employer, University of Wisconsin-Extension provides equal opportunities including Title IX and ADA requirements.

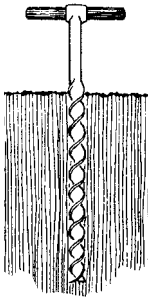

A2100

Sampling soils for testing

J.B. Peters, K.A. Kelling, and L.G. Bundy

Importance of taking good soil samples

A soil test is the only practical way of telling whether lime and fertilizer are needed. However, if a soil sample does not represent the general soil conditions of the field, the recommendations based on this sample will be useless, or worse, misleading. An acre of soil to a 6-inch depth weighs about 1,000 tons, yet less than 1 ounce of soil is used for each test in the laboratory. Therefore, it is very important that the soil sample is characteristic of the entire field. The following directions will help you collect good soil samples.

When to take soil samples

Take soil samples at any convenient time. Studies examining the effect of sampling time on soil test results suggest that test values for pH, phosphorus (P), and potassium (K) are typically slightly higher in early spring samples than in fall samples. To receive your recommendations early enough to enable you to apply the lime and fertilizer needed, it may be best to sample in the fall. Another benefit of fall testing is that fertilizer prices are more likely to be discounted then. Hayfields can be sampled after any cutting. Regardless of when you sample, it is best to be consistent from one year to the next.

Winter sampling, or sampling when the soil is frozen, is permissible only when it is possible to take a uniform boring or core of soil to the appropriate depth. This may require using a portable power boring tool. Using a pick or spade to remove a few chunks of frozen soil from the surface will give inaccurate results.

Where to take soil samples

If the field is generally uniform, fewer composite samples may be required than for fields with more variation. A composite sample consists of a core or boring taken from at least 10 different places in the area to be sampled.

Avoid sampling areas such as:

- dead furrows or back furrows
- lime, sludge, or manure piles
- animal droppings
- near fences or roads
- rows where fertilizer has been banded
- eroded knolls
- low spots

In general, do not sample any area of a field that varies widely from the rest of the field in color, fertility, slope, texture (sandy, clayey, etc.), drainage, or productivity. If the distinctive area is large enough to receive lime or fertilizer treatments different from the rest of the field, sample it separately. If manure or crop residues are on the surface, push aside these organic materials to keep from including them in the soil sample.

On contour strip fields, sample each strip separately if it is approximately 5 acres or more in size, following the sampling intensity guidelines listed in this publication. Cores from two or three small strips that have identical cropping and management histories may be combined following these same recommended sampling intensity guidelines.

Goals of a soil sampling program

When sampling soils for testing and obtaining fertilizer and lime recommendations, the most common objectives are to

1. obtain samples that accurately represent the field from which they were taken;
2. estimate the amount of nutrients that should be applied to provide the greatest economic return to the grower;
3. provide some estimate of the variation that exists within the field and how the nutrients are distributed spatially; and
4. monitor the changes in nutrient status of the field over time.

The ultimate goal of the fertility program needs to be considered before taking any samples, as that will determine how many are needed and where to sample. For example, if you intend to fertilize the entire field using a single application rate, you would need to collect fewer samples than if you plan to apply variable rates of fertilizer within the field. The second application strategy, known as site-specific management, requires special equipment to change rates of manure, lime, or fertilizer on the go. To select between the sampling strategies, consider analytical costs, field fertilization history, and the likelihood of response to variable fertilization. Each approach is outlined below.

Sampling fields for a single recommendation

With conventional sampling, you will receive a single set of results based on sample averages. The sampling guidelines in table 1 are based on when the field was last tested (more or less than 4 years) and whether the fields were responsive or non-responsive the last time they were tested (if within 4 years). The **responsive** range is considered to be where either soil test P or K levels are in the high (H) category or lower. A **non-responsive** field is one where both soil test P and K levels are in the very high (VH) or excessively high (EH) categories.

To assure accurate representation of the nutrient needs of the field, each sample should be made up of a minimum of 10 cores. Research has shown that taking 10–20 cores provides a more representative sample of the area than when samples are made up of fewer cores. Use a W-shaped sampling pattern (as shown in figure 1) when gathering composite

samples. Be sure to thoroughly mix the cores before placing approximately 2 cups in the sample bag.

It is an advantage to submit multiple samples for all fields. When at least three samples are provided, the Wisconsin soil test recommendation program will remove samples that are significantly higher than the field average. This ensures that no part of the field is under-fertilized. Where only one or two samples are submitted for a field, no sample can be discarded, whereas one sample can be discarded if three or four samples are submitted, and up to two samples may be discarded from fields having five or more samples.

Sampling fields for site-specific management

Site-specific management requires a distinct picture of the magnitude and location of soil variability. Sampling soils for site-specific management usually involves taking many more composite samples than sampling for a single recommendation. The global positioning system (GPS) is used to record the geographical coordinates of each sample. This information is used to generate an application map with mathematically derived boundaries between soil test levels. Using variable

rate application technology, these fields can be managed more intensively than the conventional approach of one fertilizer and lime rate per field.

When using a site-specific approach to soil sampling, sample handling and testing are similar to the traditional system, but recommendations may vary from one part of the field to another, and these areas must be managed separately to realize the potential advantages of intensive soil sampling.

Several sampling strategies can be used to guide variable-rate fertilizer and lime applications. **Grid sampling** uses a systematic approach that divides the field into squares of approximately equal size (grid cells). The sampling technique used is known as grid-point sampling. A grid-point sample consists of at least 10 cores collected from a small area (10-foot radius) around a geo-referenced point. When using a grid sampling approach, Wisconsin research recommends a sampling strategy based on an unaligned systematic grid (figure 2). Sampling points should be unaligned because sampling in a uniform grid arrangement may lead to biased results if aligned with row patterns. Fields that have soil test P and K levels in the non-responsive categories should be grid-point sampled on a 300-foot grid. Fields that in the past have tested in the responsive categories (interpretive levels of “high” or below) may need to be sampled on a grid no larger than 200 feet. A careful evaluation of the economics of this intensive of a sampling system needs to be done before proceeding.

Table 1. Recommended sample intensity for “uniform” fields.

Field characteristics	Field size (acres)	Suggested sample number*
Fields tested more than 4 yrs ago and fields testing in the responsive range	all fields	1 sample/5 acres
Non-responsive fields tested within past 4 yrs	5–10	2
	11–25	3
	26–40	4
	41–60	5
	61–80	6
	81–100	7

*10 cores/sample minimum.

Figure 1. Recommended W-shaped sampling pattern for a 15-acre field. Each sample should be composed of at least 10 cores.

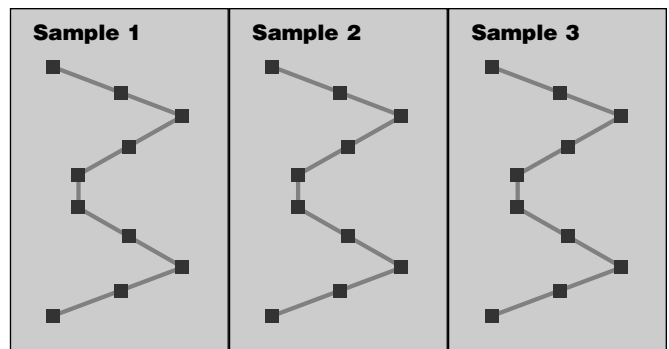

Another approach gaining support among researchers is the **management zone sampling method**, also known as directed or “smart” sampling. The basic concept of this approach is to use various layers of information that have been collected using other precision agricultural technologies such as yield maps, aerial photographs of bare soil or crop canopy, or soil electrical conductivity measurements. Directed sampling evaluates the spatial distribution of several factors that may influence nutrient availability in soil and crop productivity to help define sampling areas with similar characteristics. The grid-point method can be used in management zones with sample points clustered within the zone, rather than being uniformly dispersed in the field. If the results of grid or management zone sampling do not warrant variable-rate application (for example, relatively little between-sample variation), average them to determine the appropriate single-rate treatment.

Regardless of the strategy used, soil must be collected from several locations within the defined sampling area. Fertilizer recommendations become increasingly accurate as the number of cores per sample and the number of

samples increases. However, the value of that accuracy must be weighed against the economics of greater expense, and the practicality of taking more samples.

How to take soil samples

The following guidelines will help you take full advantage of the soil samples collected and the Wisconsin soil test recommendation program. If the soil sample is to be used in conjunction with cost-sharing programs requiring the use of a Wisconsin certified laboratory, or is being submitted as part of a nutrient management plan, these steps must be followed.

- 1. Use a sampling probe or auger to take samples.** You can obtain these tools on loan from most county Extension offices, crop consultants or fertilizer dealers.
- 2. Insert the probe or auger into the soil to plow depth or at least 6 inches.** To aid year-to-year comparisons, it is important to take repeated samplings from the same field to exactly the same depth.
- 3. Take at least 10 soil cores or borings for each composite sample** and, preferably, at least two

composite samples for every field. For non-responsive fields greater than 5 acres in size, obtain, at a minimum, the number of samples specified in table 1. For responsive fields that have not been sampled in the past 4 years, take one composite sample for every 5 acres.

- 4. Place the sample (about 2 cups) in a soil sample bag.** Sample bags are available from all soil testing labs.
- 5. Identify the bag with your name, field identification, and sample number.**
- 6. Record the field and sample location** on an aerial photo or sketch of the farm and retain for your reference.
- 7. Fill out the soil information sheet.** The more completely and carefully this sheet is filled out, the better the recommendation will be. Read the instructions on the back side of the sheet. Be sure to include the soil series name for each field. The soil series can be obtained from your Natural Resource Conservation Service (NRCS) farm plan or your country NRCS office.

What to do with soil samples

The soil samples and a completed soil information sheet can be taken to your county Extension office for forwarding to an approved soil testing laboratory. If this is not convenient, soil samples can be sent directly to the soil testing laboratory or delivered in person. Place the soil information sheet in a separate first-class envelope and attach it to the soil sample container. The soil test report containing test results and lime and fertilizer recommendations are normally returned within 2 weeks.

The University of Wisconsin-Madison, through the Department of Soil Science, operates soil testing laboratories at Madison and Marshfield. You may also use private soil testing laboratories,

Figure 2. An example of an unaligned grid pattern for sampling site-specific fields.

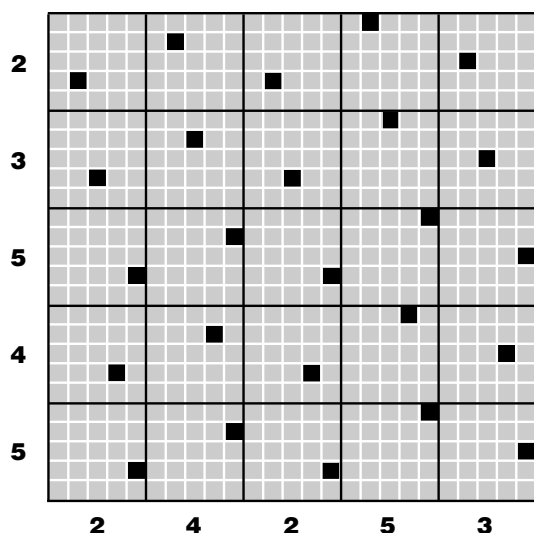

some of which are approved for cost-sharing purposes. Your county Extension office can provide you with addresses of Wisconsin Certified Labs, or you can obtain a current list at the UW Soil and Plant Analysis Laboratory web site (<http://uwlab.soils.wisc.edu>). Fee schedules for the various soil tests at the University of Wisconsin soil testing labs are available from these labs. To have your soils tested at the university laboratories send samples to either:

Soil and Plant Analysis Laboratory

5711 Mineral Point Road
Madison, WI 53705-4453
(608) 262-4364

or

Soil and Forage Analysis Laboratory

8396 Yellowstone Drive
Marshfield, WI 54449-8401
(715) 387-2523

How often to sample

For field crops, sampling the soil once every 3–4 years or once in a rotation is sufficient. Fields that are more susceptible to changes in nutrient levels, such as those with sandy soils, or those used to raise high-value crops such as potatoes should be sampled more frequently.



Tillage system considerations when sampling

Moldboard plowing. Sample to the depth of tillage.

Chisel plowing and offset disking. Take soil samples to $\frac{3}{4}$ of the tillage depth. When possible, take soil samples before spring or fall tillage. Sampling before tillage lets you determine the sampling depth more accurately and you can avoid fertilizer bands applied for the previous crop.

Till-plant and ridge tillage. Sample ridges to the 6-inch depth and furrows (between rows) to a depth of 4 inches. Combine equal numbers of soil cores from ridges and furrows to make up the composite sample.

No-till. Fields that have not been tilled for 5 years or more may develop an acid layer on the surface from the use of nitrogen fertilizer. This acid layer could reduce the effectiveness of triazine herbicides. Unincorporated phosphorus (P) and potassium (K) are also likely to build up in the surface soil. If an acid layer is suspected, take a separate sample to a depth of only 2 inches. When sending the soil to the lab, indicate that the sampling depth was only 2 inches. This sample will be tested for pH only, unless P and K are specifically requested. For fertilizer recommendations, take a separate sample to a depth of 6–7 inches. Fertilizer recommendations require this sampling depth because fertilizer calibration studies are based on plow-depth sampling. Sample between rows to avoid fertilizer bands.

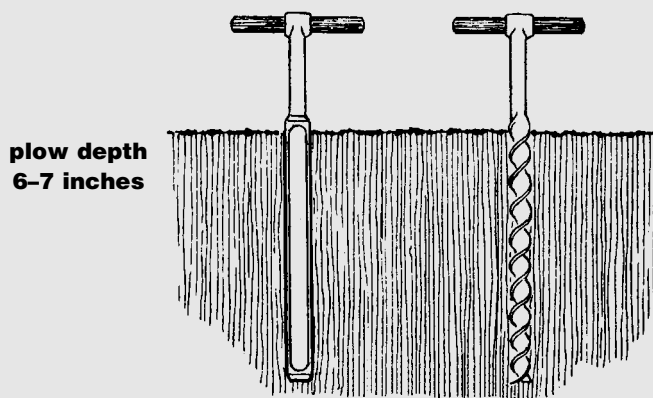

Copyright © 2002 by the Board of Regents of the University of Wisconsin System doing business as the division of Cooperative Extension of the University of Wisconsin-Extension. Send inquiries about copyright permission to: Director, Cooperative Extension Publishing, 201 Hiram Smith Hall, 1545 Observatory Dr., Madison, WI 53706.

Authors: J.B. Peters is director of the University of Wisconsin Soil and Forage Lab in Marshfield, Wisconsin, and K.A. Kelling and L.G. Bundy are professors of soil science, College of Agricultural and Life Sciences, University of Wisconsin-Madison and University of Wisconsin-Extension, Cooperative Extension. Produced by Cooperative Extension Publishing.

University of Wisconsin-Extension, Cooperative Extension, in cooperation with the U.S. Department of Agriculture and Wisconsin counties, publishes this information to further the purpose of the May 8 and June 30, 1914 Acts of Congress; and provides equal opportunities and affirmative action in employment and programming. If you need this material in an alternative format, contact the Office of Equal Opportunity and Diversity Programs or call Cooperative Extension Publishing at 608-262-2655.

This publication is available from your Wisconsin county Extension office or from Cooperative Extension Publishing, 45 N. Charter Street, Madison, WI 53715, 608-262-3346. Outside Madison, call toll free: 877-WIS-PUBS (947-7827). Before publicizing, please check on this publication's availability. To see more Extension publications, visit our web site at www1.uwex.edu/ces/pubs/.

Optimum soil test levels for Wisconsin

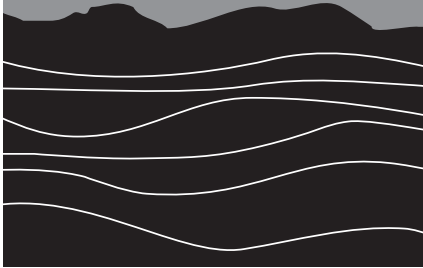

*K.A. Kelling
L.G. Bundy
S.M. Combs
J.B. Peters*

Soil test results for phosphorus, potassium, and other mineral elements are interpreted on Wisconsin soil test reports in terms ranging from very low to excessively high. This publication explains the meaning of the ratings and how they are derived for various crops and soils. Farmers and others can use this publication along with their soil test results to evaluate the overall fertility status of their farms, estimate the likelihood of profitable fertilizer responses from the fields, and decide where to invest in lime and fertilizer for the greatest economic return and crop quality.

Why test soils?

The goal of the fertilizer recommendations generated by the Wisconsin soil test program is to suggest appropriate nutrient levels for specific crops. When nutrient levels are deficient or excessive, the crop suffers.

Nutrient shortages markedly lower crop yield and quality. For example, potassium deficiencies have been linked to poor winter survival of alfalfa, lowered disease resistance, and increased lodging in corn and other grains. Insufficient amounts of nitrogen or sulfur can reduce protein levels in forages. Low calcium levels in fruits and vegetables can increase their susceptibility to several diseases.

Excesses of some elements can reduce yields by causing imbalances. Excessive amounts of boron, manganese, copper, and zinc can lead to toxicities. Also, once soil tests reach the high level, adding more nutrients is of little economic benefit. Excess nutrients build up when more fertilizer or manure is added than is removed by the harvested portions of the crop. It is important to know when to cut back on certain nutrients as well as when to add more.

Maintaining nutrients at optimum levels avoids economically damaging nutrient stress throughout the growing season while avoiding excesses that can cause agronomic or environmental problems. The best combination of economic return and maintenance of environmental quality is provided by considering nutrients from all sources. This means storing somewhat lower quantities of nutrients in the soil and meeting nutrient needs from both fertilizer applications and soil reserves.

Understanding soil test interpretations

Soil test interpretations estimate the likelihood of a profitable yield increase when a given nutrient is added. The interpretation categories are described in table 1. The tests have been calibrated so that the addition of recommended amounts of nutrients are strongly suggested when the tests are at or below the optimum level. At these levels, the likelihood of obtaining a profitable economic response to applied nutrients is very good (greater than 30%).

The optimum soil test level for a given nutrient depends on a number of factors, including crop to be grown, soil type, and contributions from the subsoil.

Interpretive levels for soil pH are given graphically on the soil test report in relation to the target pH for the most acid-sensitive crop in the indicated rotation. Table 2 lists the optimum pH levels for crops grown in Wisconsin.

Most routine soil testing programs give no interpretations for nitrogen or organic matter. Under normal or higher rainfall and optimum fertilization programs, nitrogen usually does

not accumulate in soil. Because nitrogen may leach over winter, attempting to build up nitrogen in the soil is neither practical nor environmentally wise. Recommended application rates given in the routine soil test report are estimates of crop nitrogen needs for the indicated soil and assume good soil management practices are used. The recommended rates of nitrogen were determined through experiments that measured plant response on various soils. These studies showed that for some crops, including corn, the optimum rate of nitrogen on a given soil was similar in both high- and low-yielding years. For this reason, recommended nitrogen rates for corn are not based on expected yield but are soil specific. Use of special tests (e.g., spring preplant profile nitrate test and presidedress nitrogen test) can more precisely determine the specific nitrogen need.

Soil organic matter levels are controlled by factors such as soil aeration, drainage and tillage systems and cannot be increased easily without large additions of manure or other organic material or by switching to reduced tillage.

Crop demand levels

Crops differ in their need for nutrients. The optimum potassium level for alfalfa is higher than that needed for red clover. To account for different phosphorus and potassium needs, crops have been placed in one of six demand levels: (1) corn; (2) soybeans and low-demand field crops; (3) alfalfa, irrigated field crops, and low-demand vegetable crops; (4) red clover and other medium-demand field crops; (5) high-demand vegetable crops; and (6) potatoes.

The demand level assignments for the various crops are given in table 2. These demand levels were established so that if the soil test is in the optimum range, then crop yield and profit are optimized by adding the quantity

of nutrients approximately equivalent to the amount present in the harvested part of the crop.

Subsoil contributions

Nutrients present in the subsoil can contribute significantly to the nutrition of crops. Roots that reach down into the subsoil can use the nutrients stored there, so the level of phosphorus and potassium present in the plow layer becomes slightly less important. For example, recent research at Arlington showed that alfalfa obtained about 100 lb of potash (K_2O equivalent) per year from the subsoil.

Some subsoils are higher in phosphorus and potassium than others. To reflect this difference, the soil test report uses the subsoil fertility groups illustrated in figure 1 to distinguish different soils. These groups are based on soil samples collected at a depth of 8–30 inches from every county in a 1960 statewide survey.

When sending in soil samples for testing and fertilizer recommendations, include the soil name on the information sheet. The soil name is used to assign the correct subsoil group and to interpret soil test phosphorus and potassium data (tables 3 and 4). If the name is not given, the computer “guesses” the soil group based on soil pH, soil texture, organic matter, and county of origin. This procedure obviously does not permit as precise a fertilizer recommendation as when soil name is given. For soil name information contact your county Extension office or Natural Resource Conservation Service (NRCS). A list of the subsoil fertility groups for each of the 699 soil types currently recognized in Wisconsin may be found in Extension publication *Soil Test Recommendations for Field, Vegetable, and Fruit Crops* (A2809).

Subsoil fertility groups are also used to determine nutrient buffering capacities or how much phosphate or potash is required to raise soil test P or K to the optimum level. As shown in figure 1, soil in subsoil group D requires 18 pounds of P_2O_5 per acre to change soil test P by 1 part per million (ppm). A soil in subsoil group E, on the other hand, requires only 12 pounds of P_2O_5 per acre to raise soil test P by 1 ppm.

Secondary nutrients and micronutrients

Soil tests are available upon request for secondary nutrients calcium, magnesium, and sulfur as well as trace nutrients zinc, boron, and manganese. The interpretations for these tests are given in table 5.

The sulfur availability index in table 5 is calculated by summing sulfur contributions from estimates of sulfur released from organic matter, precipitation, subsoil, and manure as well as sulfate sulfur (SO_4-S) determined by the soil test. The procedures for estimating the amounts of sulfur contributed from these sources are described in Extension publication *Soil Test Recommendations for Field, Vegetable, and Fruit Crops* (A2809).

Available manganese is influenced both by soil pH and organic matter. When organic matter exceeds 6%, manganese availability is predicted from soil pH rather than the manganese test itself. This interpretation is shown in table 5.

Presently, there are no soil tests for copper, iron, molybdenum, and chlorine calibrated for Wisconsin soil conditions. The likelihood of deficiencies of these micronutrients is too rare to justify developing soil tests for them. If you suspect deficiencies of these nutrients, plant analysis should be used to confirm the need for making an application.

Figure 1. General subsoil fertility groups, based on available phosphorus and potassium in subsoils

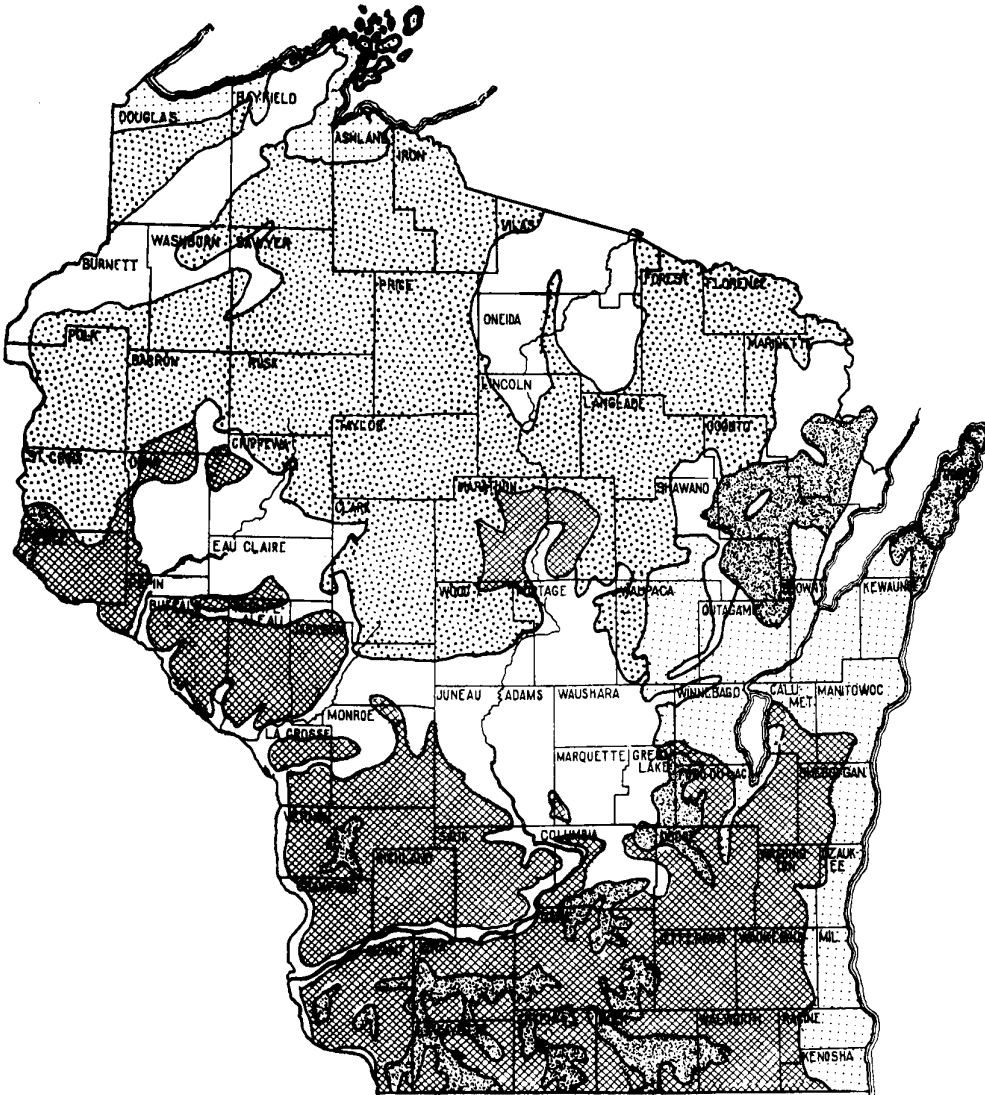

Subsoil group	Legend	Nutrient supplying power ^a	Nutrient buffering capacity ^b	
			P ₂ O ₅	K ₂ O
A		P high, K medium	18	7
B		P medium, K medium	18	7
C		P low, K high	18	7
D		P medium, K low	18	7
E		P variable, K low	12	6
O	*	P variable, K low	18	5
X	*	P low	18	—

*Scattered throughout the state.

^aAll data refer to subsoils (8" to 30") only. Low, medium and high ratings are relative and are not defined in absolute units. Adapted from M.T. Beatty and R.B. Corey, 1961.

^bThe soil nutrient buffering capacity is the approximate amount of fertilizer in lb/a (oxide basis) required to change the soil test level (elemental basis) by 1 ppm.



Table 1. Codes and descriptions of soil test interpretation categories

—Category—			Probability of yield increase ^a (%)
Name	Symbol	Description	
Very low	VL	Substantial quantities of nutrients are required to optimize crop yield. Buildup should occur over a 5- to 8-year period. Response to secondary or micronutrients is likely or possible for high or medium demanding crops, respectively.	>90
Low	L	Somewhat more nutrients than those removed by crop harvest are required. Response to secondary or micronutrients is possible for high demanding crops, but unlikely for medium or low demanding crops.	60–90
Optimum	Opt	This is economically and environmentally the most desirable soil test category. Yields are optimized at nutrient additions approximately equal to amounts removed in the harvested portion of the crop. Response to secondary or micronutrients is unlikely regardless of crop demand level.	30–60
High	H	Some nutrients are required, and returns are optimized at rates equal to about one-half of nutrient removal by the crop.	5–30
Very high	VH	Used only for potassium. Soil tests are above the optimum range and gradual draw-down is recommended. Approximately one-fourth of nutrient removal is recommended.	≈5
Excessively high	EH	No fertilizer is recommended for most soils since the soil test level will remain in the nonresponsive range for at least two to three years. On medium- and fine-textured soils, a small amount of starter fertilizer is advised for row crops.	<2

^a Percentage of fields that can be expected to show a profitable yield increase when recommended nutrients are applied.

Table 2. Crop codes, optimum soil pH values, and phosphorus and potassium demand levels for each crop

Crop code and name	Lime rec. Target pH		P and K demand level	Crop code and name	Lime rec. Target pH		P and K demand level
	Mineral	Organic			Mineral	Organic	
1 Alfalfa	6.8	—	3	35 Pea, canning	6.0	5.6	3
2 Alfalfa seeding	6.8	—	3	36 Pea (chick, field, cow)	6.0	5.6	3
3 Asparagus	6.0	5.6	5	37 Pepper	6.0	5.6	5
4 Barley	6.6	5.6	4	38 Popcorn	6.0	5.6	3
5 Bean, dry (kidney, navy)	6.0	5.6	3	39 Potato	5.2/6.0	5.2/5.6	6
6 Bean, lima	6.0	5.6	3	40 Pumpkin	6.0	5.6	5
7 Beet, table	6.0	5.6	5	41 Reed canarygrass	6.0	5.6	2
8 Brassica, forage	6.0	5.6	3	42 Red clover	6.3	5.6	4
9 Broccoli	6.0	5.6	5	43 Rye	5.6	5.4	4
10 Brussels sprout	6.0	5.6	5	44 Snapbean	6.8	5.6	3
11 Buckwheat	5.6	5.4	2	45 Sod	6.0	5.6	2
12 Cabbage	6.0	5.6	5	46 Sorghum, grain	5.6	5.4	2
13 Canola	5.8	5.6	1	47 Sorghum-sudan forage	5.6	5.4	2
14 Carrot	5.8	5.6	5	48 Soybean	6.3	5.6	2
15 Cauliflower	6.0	5.6	5	49 Spinach	6.0	5.6	5
16 Celery	6.0	5.6	5	50 Squash	6.0	5.6	5
17 Corn, grain	6.0	5.6	1	51 Sunflower	6.0	5.6	1
18 Corn, silage	6.0	5.6	1	52 Tobacco	5.8	5.6	5
19 Corn, sweet	6.0	5.6	3	53 Tomato	6.0	5.6	5
20 Cucumber	5.8	5.6	5	54 Trefoil, birdsfoot	6.0	5.6	4
21 Flax	6.0	5.6	2	55 Triticale	6.0	5.6	4
22 Ginseng	6.3	5.6	5	56 Truck crops	6.0	5.6	5
23 Lettuce	5.8	5.6	5	57 Vetch (crown, hairy)	6.0	5.6	4
24 Lupine	6.3	5.6	4	58 Wheat	6.0	5.6	3
25 Melon	5.8	5.6	5	59 Miscellaneous	—	—	—
26 Millet	5.6	5.4	2	60 Apple ^c	6.0	—	3
27 Mint, oil	6.0	5.6	5	61 Blueberry	4.5	4.5	3
28 Oat	5.8	5.6	4	62 Cherry ^c	6.0	—	3
29 Oatlage ^a	6.8	—	4	63 Cranberry	4.5	4.5	3
30 Oat-pea forage ^a	6.8	—	4	64 Raspberry	6.0	5.6	3
31 Onion	5.6	5.4	5	65 Strawberry	6.0	5.6	3
32 Pasture, unimproved	6.0	5.6	2	66 CRP, alfalfa	6.6	—	3
33 Pasture, managed ^b	6.0	5.6	1	67 CRP, red clover	6.3	5.6	4
34 Pasture, legume-grass	6.0	—	4	68 CRP, grass	5.6	5.4	2

^aAssumes alfalfa underseeding.

^bIncludes bromegrass, fescue, orchardgrass, ryegrass, and timothy.

^cLime recommendations for apples and cherries apply only to preplant tests. Adjustment of pH is impractical once an orchard is established.

Table 3. Soil test interpretation ranges for phosphorus

Subsoil fert. group	Soil test category				
	Very low (VL)	Low (L)	Optimum (Opt)	High (H)	Excessively high (EH)
soil test P, ppm ^a					
Demand level 1 (corn)					
A	<5	5–10	11–15	16–25	>25
B	<10	10–15	16–20	21–30	>30
C	<10	10–15	16–20	21–30	>30
D	<8	8–12	13–18	19–28	>28
E	<12	12–22	23–32	33–42	>42
O	<12	12–22	23–32	33–42	>42
X	<5	5–8	9–15	16–25	>25
Demand level 2 (soybeans and low-demand field crops)					
A	—	<6	6–10	11–20	>20
B	—	<6	6–10	11–20	>20
C	—	<8	8–13	14–23	>23
D	—	<6	6–10	11–20	>20
E	—	<10	10–15	16–25	>25
O	—	<10	10–15	16–25	>25
X	—	<6	6–10	11–17	>17
Demand level 3 (alfalfa, irrigated field crops, and low-demand vegetable crops)					
A	<10	10–15	16–23	24–32	>32
B	<10	10–17	18–23	24–30	>30
C	<12	12–17	18–25	26–35	>35
D	<10	10–15	16–23	24–30	>30
E	<18	18–25	26–37	38–55	>55
O	<18	18–25	26–37	38–55	>55
X	<5	5–10	11–15	16–23	>23
Demand level 4 (red clover and medium-demand field crops)					
A	<10	10–15	16–20	21–25	>25
B	<10	10–15	16–20	21–25	>25
C	<12	12–17	18–23	24–30	>30
D	<8	8–12	13–18	19–23	>23
E	<15	15–22	23–30	31–38	>38
O	<15	15–22	23–30	31–38	>38
X	<5	5–10	11–15	16–20	>20
Demand level 5 (high-demand vegetable crops)					
A	<15	15–30	31–45	46–75	>75
B	<15	15–30	31–45	46–75	>75
C	<15	15–30	31–45	46–75	>75
D	<15	15–30	31–45	46–75	>75
E	<18	18–35	36–50	51–80	>80
O	<18	18–35	36–50	51–80	>80
X	<10	10–25	26–40	41–60	>60
Demand level 6 (potato)					
A	<100	100–160	161–200	>200	—
B	<100	100–160	161–200	>200	—
C	<100	100–160	161–200	>200	—
D	<100	100–160	161–200	>200	—
E	<60	60–90	91–125	126–160	>160
O	<60	60–90	91–125	126–160	>160
X	<36	36–60	61–75	76–120	>120

^appm (wt/vol; g/m³)

Table 4. Soil test interpretation ranges for potassium

Subsoil fert. group	Soil test category					
	Very low (VL)	Low (L)	Optimum (Opt)	High (H)	Very high (H)	Excessively high (EH)
soil test K, ppm ^a						
Demand level 1 (corn)						
A	<60	60–80	81–100	101–140	—	>140
B	<70	70–90	91–110	111–150	—	>150
C	<60	60–70	71–100	101–140	—	>140
D	<70	70–100	101–130	131–160	—	>160
E	<45	45–65	66–90	91–130	—	>130
O	<45	45–65	66–90	91–130	—	>130
Demand level 2 (soybeans and low-demand field crops)						
A	<50	50–80	81–100	101–120	121–140	>140
B	<50	50–80	81–100	101–120	121–140	>140
C	<40	40–70	71–90	91–110	111–130	>130
D	<70	70–100	101–120	121–140	141–160	>160
E	—	<60	60–80	81–100	101–120	>120
O	—	<60	60–80	81–100	101–120	>120
Demand level 3 (alfalfa, irrigated field crops and low-demand vegetable crops)						
A	<70	70–90	91–120	121–150	151–170	>170
B	<70	70–90	91–120	121–150	151–170	>170
C	<55	55–70	71–100	101–130	131–150	>150
D	<90	90–110	111–140	141–170	171–200	>200
E	<50	50–80	81–120	121–160	161–180	>180
O	<50	50–80	81–120	121–160	161–180	>180
Demand level 4 (red clover and medium-demand field crops)						
A	<55	55–70	71–100	101–120	121–150	>150
B	<55	55–70	71–100	101–120	121–150	>150
C	<50	50–65	66–90	91–110	111–130	>130
D	<60	60–80	81–120	121–140	141–160	>160
E	<45	45–60	61–90	91–110	111–130	>130
O	<45	45–60	61–90	91–110	111–130	>130
Demand level 5 (high-demand vegetable crops)						
A	<60	60–120	121–180	181–200	201–220	>220
B	<60	60–120	121–180	181–200	201–220	>220
C	<50	50–110	111–160	161–180	181–200	>200
D	<80	80–140	141–200	201–220	221–240	>240
E	<50	50–100	101–150	151–165	166–180	>180
O	<50	50–100	101–150	151–165	166–180	>180
Demand level 6 (potato)						
A	<80	80–120	121–160	161–180	181–210	>210
B	<80	80–120	121–160	161–180	181–210	>210
C	<70	70–100	101–150	151–170	171–190	>190
D	<80	80–120	121–170	171–190	191–220	>220
E	<70	70–100	101–130	131–160	161–190	>190
O	<70	70–100	101–130	131–160	161–190	>190

^appm (wt/vol; gm/m³)



Table 5. Interpretation of soil test values for secondary nutrients and micronutrients

Element	Soil texture code ^a	Soil test category				
		Very low (VL)	Low (L)	Optimum (Opt)	High (H)	Excessively high (EH)
		soil test, ppm				
Calcium	1	0–200	201–400	401–600	>600	—
	2,3,4	0–300	301–600	601–1000	>1000	—
Magnesium	1	0–25	26–50	51–250	>250	—
	2,3,4	0–50	51–100	101–500	>500	—
Boron	1	0–0.2	0.3–0.4	0.5–1.0	1.1–2.5	>2.5
	2,4	0–0.3	0.4–0.8	0.9–1.5	1.6–3.0	>3.0
	3	0–0.5	0.6–1.0	1.1–2.0	2.1–4.0	>4.0
Zinc	1,2,3,4	0–1.5	1.6–3.0	3.1–20	21–40	>40
Manganese	1,2,3,4	—	0–10	Soil pH		—
				11–20	>20	
O.M. less than 6.1%	1,2,3,4	—	>6.9	6.0–6.9	<6.0	—
O.M. more than 6.0%	1,2,3,4	—	>6.9	6.0–6.9	<6.0	—
		SAI ^b				
Sulfur	1,2,3,4	—	<30	30–40	>40	—

^aSoil texture codes: 1 = sandy soils; 2 = loams, silts, and clays; 3 = organic soils; 4 = red soils.

^bSulfur availability index (SAI) includes estimates of sulfur released from organic matter, sulfur in precipitation, subsoil sulfur and sulfur in manure if applied, as well as sulfate sulfur (SO₄-S) determined by soil test.



Copyright © 1999 by the Board of Regents of the University of Wisconsin System doing business as the division of Cooperative Extension of the University of Wisconsin-Extension. Send inquiries about copyright permission to: Director, Cooperative Extension Publishing, 201 Hiram Smith Hall, 1545 Observatory Dr., Madison, WI 53706.

Authors: K.A. Kelling and L.G. Bundy are professors of soil science, College of Agricultural and Life Sciences, University of Wisconsin-Madison and University of Wisconsin-Extension, Cooperative Extension. S.M. Combs is director of the University of Wisconsin Soil and Plant Analysis Lab-Madison, and J.B. Peters is director of the University of Wisconsin Soil and Forage Lab-Marshfield. Produced by Cooperative Extension Publishing.

University of Wisconsin-Extension, Cooperative Extension, in cooperation with the U.S. Department of Agriculture and Wisconsin counties, publishes this information to further the purpose of the May 8 and June 30, 1914 Acts of Congress; and provides equal opportunities and affirmative action in employment and programming. If you need this material in an alternative format, contact the Office of Equal Opportunity and Diversity Programs or call Cooperative Extension Publishing at 608-262-2655.

This publication is available from your Wisconsin county Extension office or from Cooperative Extension Publishing, Rm. 170, 630 W. Mifflin Street, Madison, WI 53703, 608-262-3346. Outside Madison, call our toll-free number: 877-WIS-PUBS (947-7827). Before publicizing, please check on this publication's availability. To see more Extension publications, visit our web site at www.uwex.edu/ces/pubs/.

Soil and Applied Nitrogen

L.G. Bundy

The atmosphere contains about 78% nitrogen gas (N_2). This is the equivalent of more than 30,000 tons/a. However, most plants cannot use nitrogen as it exists in the atmosphere. It must first be converted through biological or chemical fixation.

1. Biological fixation—Rhizobia and other bacteria that live in the roots of legumes take nitrogen from the air and fix it in a form that plants can use. This mutually beneficial relationship between microorganisms and plants is called symbiosis.

Figure 1. The nitrogen cycle. Biological transformations of nitrogen in soil are numbered and explained under “Nitrogen Reactions in Soils.”

2. Chemical fixation—In the manufacture of chemical nitrogen fertilizer, atmospheric nitrogen (N_2) is combined with hydrogen (H_2) to form ammonia (NH_3). Ammonia can be sold for direct application, or it can be used to manufacture other forms of nitrogen fertilizer such as ammonium nitrate (NH_4NO_3) or urea ($CO(NH_2)_2$).

Nitrogen exists in many different forms. Several physical, chemical, and biological processes affect its availability to plants. Collectively, these transformations make up the nitrogen cycle, illustrated in Figure 1.

NITROGEN REACTIONS IN SOILS

Biological Transformations

Symbiotic fixation. Legumes inoculated with the proper strain of nodule-forming bacteria use atmospheric nitrogen (Reaction 1 in Figure 1). Most legumes fix all the nitrogen they need and do not need nitrogen fertilizer. In addition, many legumes supply substantial amounts of nitrogen to the succeeding crop.

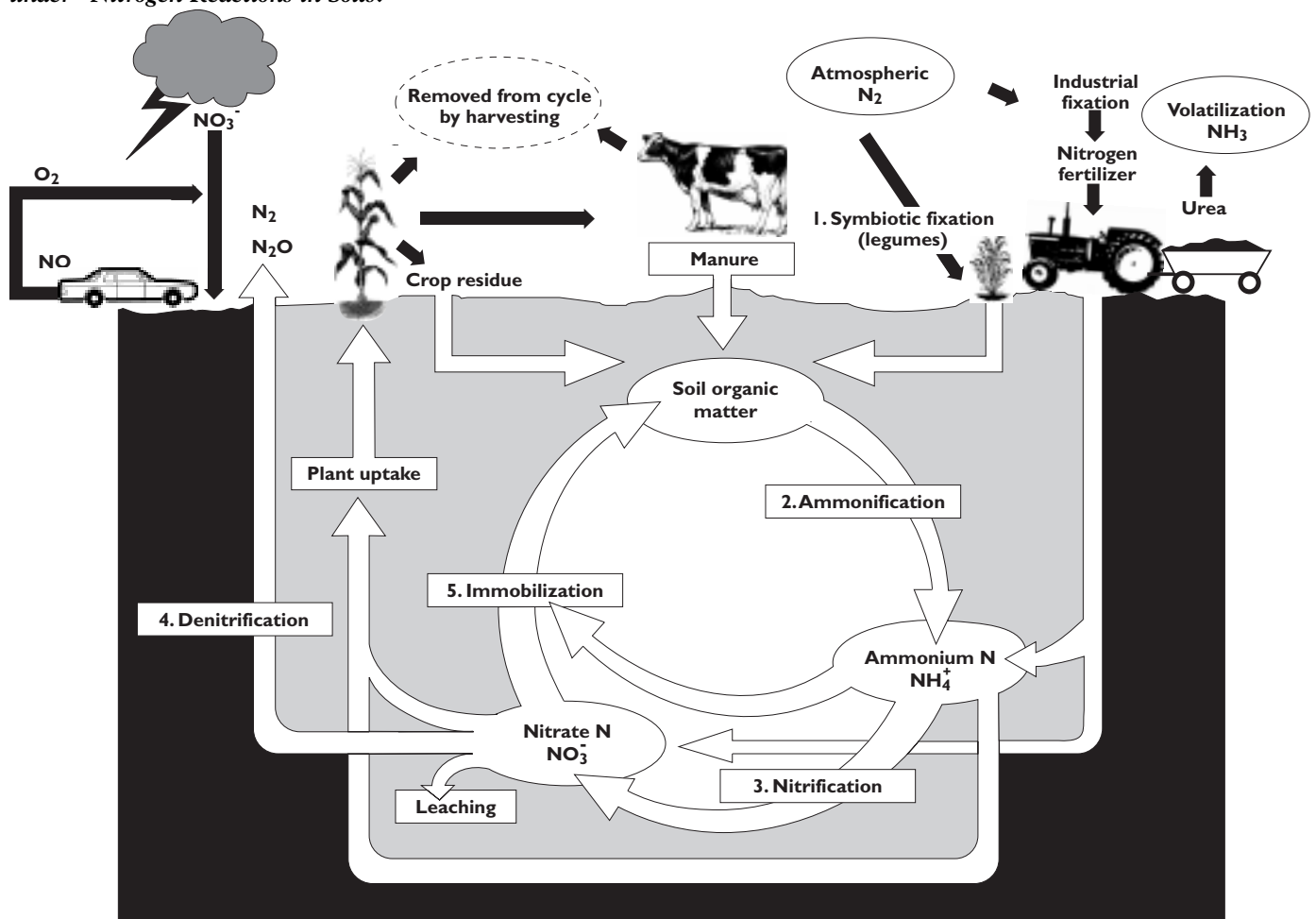



Ammonification. This is the conversion of organic nitrogen into ammonium by soil microbes (Reaction 2 in Figure 1). Plants can use ammonium nitrogen, and it is not lost by leaching. Negatively charged particles of clay minerals and soil organic matter hold the positively charged ammonium ion (NH_4^+). This greatly restricts its movement by percolating water.

Nitrification. This is the conversion of ammonium nitrogen to nitrate nitrogen by soil bacteria (Reaction 3 in Figure 1). Nitrate ions (NO_3^-) are readily available to plants. However, their negative charge causes them to remain in solution in the soil, and they can be leached below the root zone by percolating water.

Nitrification occurs rapidly in warm, well-aerated, and properly limed soils (pH of 6.5–7.0). When conditions are favorable, the ammonium form of nitrogen in fertilizers is changed to the nitrate form within 1–2 weeks after application.

Denitrification. In poorly aerated, water-logged soils, soil bacteria change available nitrate nitrogen into unavailable atmospheric nitrogen (Reaction 4 in Figure 1). Decomposable organic matter must be present as a source of energy for denitrification to occur. This energy requirement often limits denitrification deep in the subsoil or in groundwater.

Denitrification takes place very rapidly. If water stands on the soil for only 2–3 days during the growing season, most of the nitrate nitrogen will be lost through denitrification. Yellowing of corn and other crops grown on poorly aerated soils is often due to a nitrogen deficiency.

Immobilization. Carbon-rich crop residues, such as straw or corn stalks, can cause temporary nitrogen deficiency because the bacteria that decompose the residues temporarily immobilize or “tie up” available ammonium or nitrate nitrogen (Reaction 5 in Figure 1). Most of the

nitrogen immobilized as microbial protein becomes part of the soil organic matter and is slowly released in a plant-available form as the organic matter decomposes.

The addition of nitrogen fertilizer sometimes is recommended to hasten decomposition of crop residues. However, most well-managed soils contain enough nitrogen to break down the crop residue. The size of the residue particles usually is more important than the amount of nitrogen in determining how fast residues will decompose in soil: small particles decompose much more rapidly than large particles. For rapid decomposition, chop or shred corn stalks and other crop residues.

NITROGEN LOSSES

Leaching

Leaching of nitrate nitrogen can be a serious problem, especially on sandy soils. Because sandy soils retain only about 1 inch of water per foot of soil, relatively small amounts of rain or irrigation water readily move nitrate below the root zone. Well-drained silt and clay soils retain about 3 inches of water per foot of soil, so rapid leaching occurs in these soils only when rainfall is abnormally high.

Ammonium nitrogen is held on soil particles and is essentially non-leachable. Nitrate nitrogen is not held by soil particles and can be leached below the root zone. This does not mean that ammonium nitrogen is more effective than nitrate nitrogen. Ammonium nitrogen quickly changes to nitrate nitrogen under optimum soil conditions. As a result, nitrogen loss through leaching can occur even where nitrogen is initially applied as ammonium.

Volatilization

When manure, urea fertilizer, or solutions containing urea are surface applied and not worked into the soil, some nitrogen can be lost as ammonia

gas. Direct loss of ammonia from anhydrous ammonia occurs if the material is not properly injected into the soil. Proper injection of solutions containing ammonia and immediate incorporation of manure and urea-containing fertilizer eliminate volatilization losses. A light rainfall (0.1–0.2 inches) within 1–2 days after surface application of urea-containing fertilizers will greatly reduce or eliminate ammonia volatilization. Little ammonia loss will occur when ammonium nitrate, ammonium sulfate, or ammonium phosphate are surface applied on acid or neutral soils. Incorporate ammonium sulfate or ammonium phosphate on high-pH soils. (See also “Urease Inhibitors” on page 4.)

Denitrification

As previously noted, most of the available nitrate nitrogen in soil converts to unavailable atmospheric nitrogen when soils are poorly aerated. It is important, therefore, to provide adequate surface or subsoil drainage on soils that tend to be poorly drained.

SOURCES OF NITROGEN

Organic Matter

Soils often contain 2,000–6,000 lb/a of organic nitrogen, but almost all of this nitrogen is combined in stable organic matter (humus) that decomposes very slowly. Mineral soils in Wisconsin supply only about 25–75 lb/a of available nitrogen annually. Nonlegume crops usually require additional nitrogen from fertilizer, previous legumes, or manure to achieve optimum yields.

Nitrogen Fertilizers

Many different chemical and physical forms of nitrogen fertilizer are available. If properly applied, the various forms are equally effective, although one form may have an advantage over another under certain conditions. Table 1 lists the general characteristics of the important fertilizer sources of nitrogen.

Table 1. Nitrogen fertilizers.

FERTILIZER	CHEMICAL FORMULATION	ANALYSIS (N-P ₂ O ₅ -K ₂ O)	PHYSICAL FORM	METHOD OF APPLICATION
Ammonium nitrate	NH ₄ NO ₃	33-0-0	dry prills	Broadcast or sidedress. Can be left on the soil surface.
Ammonium sulfate	(NH ₄) ₂ SO ₄	21-0-0	dry granules	Broadcast or sidedress. Can be left on the soil surface. ^a
Anhydrous ammonia	NH ₃	82-0-0	high-pressure liquid	Must be injected 6–8 inches deep on friable ^b moist soil. Excessive loss will occur from wet soils.
Aqua ammonia	NH ₄ OH	20-0-0 to 24-0-0	low-pressure liquid	Must be injected 2–3 inches deep on friable ^b moist soils. Excessive loss will occur from wet soils.
Calcium nitrate	Ca(NO ₃) ₂	15.5-0-0	dry granules	Broadcast or apply in the row. Can be left on the soil surface.
Diammonium phosphate	(NH ₄) ₂ HPO ₄	18-46-0	dry granules	Broadcast or apply in the row. Can be left on the soil surface. ^a
Low-pressure nitrogen solutions	NH ₄ NO ₃ + NH ₃ + H ₂ O	37-0-0 41-0-0	low-pressure liquid	Must be injected 2–3 inches deep on friable ^b moist soils. Excessive loss will occur from wet soils.
Potassium nitrate	KNO ₃	13-0-44	dry granules	Broadcast or apply in the row. Can be left on the soil surface.
Pressureless nitrogen solutions	NH ₄ NO ₃ + urea + H ₂ O	28-0-0 32-0-0	pressureless liquid	Spray on surface or sidedress. Incorporate surface applications to prevent volatilization loss of NH ₃ from urea.
Urea	CO(NH ₂) ₂	45-0-0	dry prills or granules	Broadcast or sidedress. Incorporate surface applications to prevent volatilization loss of NH ₃ from urea.

^aIncorporate on high pH soils.

^bFriable soils are those which are easily crumbled or pulverized.

Timing of application. The timing of nitrogen fertilizer applications can markedly affect their efficiency and the potential for nitrogen losses. Supplying the needed nitrogen just prior to the crop's greatest demand maximizes the efficiency of nitrogen applications. For spring-planted crops, sidedress and spring preplant applications provide greater nitrogen efficiency than fall applications, which are usually 10–15% less effective in increasing crop yields.

Fall applications are most effective on medium-textured, well-drained soils, where nitrogen loss through leaching and denitrification is usually

low. They are *not* effective on sandy soils, shallow soils over fractured bedrock, or fine-textured, poorly drained soils. Price and convenience advantages frequently associated with fall-applied nitrogen must be weighed against the possibility of lower effectiveness and nitrate nitrogen losses.

Sidedress nitrogen applications during the growing season are effective on all soils. Proper timing of these applications is essential to provide available nitrogen during the period in which the crop uses nitrogen rapidly. Benefits from using sidedress instead of preplant applications are greatest on

sandy soils or on fine-textured, poorly drained soils.

Spring preplant applications are usually as effective as sidedress treatments on medium-textured, well-drained soils, because the risk of leaching or denitrification on these soils is low.

Nitrification inhibitors. Using a nitrification inhibitor such as nitrapyrin (N-Serve) or dicyandiamide (DCD) with ammonium forms of nitrogen fertilizer can reduce nitrogen losses on soils where leaching or denitrification is likely. Nitrification inhibitors slow the conversion of ammonium to nitrate by soil organisms (Reaction 3 in

Figure 1). Because leaching and denitrification occur through the nitrate form of nitrogen, maintaining fertilizer nitrogen in the ammonium form should reduce nitrogen losses through these processes.

Nitrification inhibitors are likely to increase crop yields when used with spring preplant nitrogen applications on sandy soils or fine-textured, poorly drained soils. Yield increases are also likely from inhibitor use with fall-applied nitrogen on medium-textured, well-drained soils. However, spring-applied nitrogen fertilizer is usually more effective than fall-applied nitrogen even with use of a nitrification inhibitor. Using nitrification inhibitors with spring preplant nitrogen on medium-textured, well-drained soils or with sidedress applications on any soil type is not likely to improve yields.

Urease inhibitors. Use of urease inhibitors such as NBPT (Agrotain) with surface-applied urea-containing fertilizers can reduce ammonia losses and improve nitrogen efficiency. However, they do not consistently increase yields. The decision to use a urease inhibitor will depend on the risk of nitrogen loss that could be controlled, the cost of using the inhibitor, and the cost and convenience of other nitrogen sources or placement methods that are not subject to ammonia loss. Alternatives include injecting or incorporating the urea-containing fertilizers or using non-urea nitrogen sources.

Nitrogen management recommendations. To minimize leaching or denitrification losses, follow these general recommendations.

1. Sandy soils—Apply nitrogen as a sidedress treatment. Fall or spring preplant treatments result in excessive

losses on sandy soils. If you must use spring preplant applications, apply ammonium forms of nitrogen treated with a nitrification inhibitor. For irrigated crops, apply part of the nitrogen through the irrigation water.

2. Well-drained silty or clayey soils—Spring preplant or sidedress applications can contain any form of nitrogen. If you must make fall applications, use ammonium forms of nitrogen with a nitrification inhibitor.

3. Poorly drained soils—Use sidedress applications or apply nitrification inhibitors with spring preplant treatments.

Legumes

Legumes can supply substantial amounts of nitrogen to the succeeding crop. Table 2 indicates the nitrogen credit that should be given to various legume crops. For additional information, see Extension publication *Using Legumes as a Nitrogen Source* (A3517).

Table 2. Nitrogen credits for previous legume crops.^a

LEGUME CROP	NITROGEN CREDIT	EXCEPTIONS
Forages		
First-year credit		
Alfalfa	190 lb/a N for a good stand ^b 160 lb/a N for a fair stand ^b 130 lb/a N for a poor stand ^b	Reduce credit by 50 lb/a N on sandy soils. ^c Reduce credit by 40 lb/a N if plant regrowth was less than 6–10 inches prior to tillage or plant death.
Birdsfoot trefoil, red clover	Use 80% of alfalfa credit.	Same as alfalfa.
Second-year credit		
Fair or good stand	50 lb/a N	No credit on sandy soils. ^c
Green manure crops		
Alfalfa	60–100 lb/a N	Use 40 lb/a N credit if field has less than 6 inches of growth before tillage.
Red clover	50–80 lb/a N	
Sweet clover	80–120 lb/a N	
Soybean	40 lb/a N	No credit on sandy soils. ^c
Leguminous vegetable crops		
Pea, lima bean, snap bean	20 lb/a N	No credit on sandy soils. ^c

^aLegume credits to a following corn crop can be confirmed by using the presidedress nitrogen test (PSNT) when corn is 6–12 inches tall.

^bA good stand of alfalfa (>70% alfalfa) has more than 4 plants/ft²; a fair stand (30–70% alfalfa) has 1.5–4 plants/ft²; and a poor stand (<30% alfalfa) has less than 1.5 plants/ft².

^cSandy soils are sands and loamy sands.

Table 3. Nitrogen content and first-year credits for solid and liquid manure.

TYPE OF MANURE	% OF TOTAL N AVAILABLE IN FIRST YEAR	APPLICATION METHOD	NITROGEN CONTENT OF MANURE			
			SOLID (lb/ton)		LIQUID (lb/1000 gal)	
			TOTAL	N CREDIT	TOTAL	N CREDIT
Beef	25%	Surface	14	4	40	10
	30%	Incorporated ^a	14	4	40	12
Dairy	30%	Surface	10	3	28	8
	35%	Incorporated ^a	10	4	28	10
Poultry	50%	Surface	25	13	70	35
	60%	Incorporated ^a	25	15	70	41
Swine	40%	Surface	10	4	55	22
	50%	Incorporated ^a	10	5	55	28

^aInjected or incorporated within 72 hours of application.

Adapted from: USDA-SCS. Wisconsin Field Office Technical Guide. Sec. IV. Spec. 590.

Manure

Manure contains substantial amounts of nitrogen, but much of the nitrogen is in the organic form and is not all available in the first year following application. The amount of manure nitrogen available to a crop depends on the type of manure, the application rate, the method of application, and the consecutive years of application. Reduce or eliminate fertilizer nitrogen applications when you apply manure. Table 3 lists first-year nitrogen credits for solid and liquid manure. For additional information, see Extension publication *Guidelines for Applying Manure to Cropland and Pastures in Wisconsin* (A3392).

Precipitation

In rural areas in Wisconsin, precipitation accounts for about 10 lb/a of available nitrogen (ammonium + nitrate nitrogen) annually. This is a small addition on a per-acre basis, but it is a significant contribution to the total nitrogen budget for the state.

DIAGNOSTIC TECHNIQUES

Deficiency Symptoms

Lack of nitrogen first appears as a light green coloring of the plant. As the deficiency becomes more severe, leaves turn yellow and may “fire.” Nitrogen deficiency first appears on the

plant’s lower leaves and gradually progresses up the plant. On corn, this yellowing starts at the midrib of the leaf with the edge of the leaf remaining green. Corn, small grains, and forage grasses all require relatively high amounts of nitrogen and show deficiency symptoms whenever nitrogen is in short supply. Yellowing of the bottom few leaves as corn plants approach physiological maturity is normal and usually does not indicate a nitrogen deficiency.

Soil Analysis

Nearly all nitrogen in the soil is in the unavailable organic form. The amount of organic nitrogen that soil bacteria convert to an available form depends on such environmental factors as temperature, rainfall, and soil oxygen levels. Soil organic matter content provides a general indication of the soil’s nitrogen-supplying capability, and nitrogen recommendations in Wisconsin take this source of nitrogen into account.

Soil nitrate testing allows nitrogen fertilizer recommendations to be adjusted for field-specific conditions that can influence crop nitrogen needs. Two nitrate tests, a preplant soil nitrate test and a presidedress soil nitrate test, are available for improving the efficiency of nitrogen fertilizer applica-

tions. These tests offer economic and environmental benefits. Economically, tailoring nitrogen applications to crop needs saves fertilizer dollars. Environmentally, avoiding over-application of nitrogen reduces the potential for nitrate movement to groundwater.

A preplant soil profile nitrate test (PPNT) is useful for predicting site-specific nitrogen fertilizer needs, particularly for corn production. Soil samples, taken in 1-foot increments to a depth of 2 feet, are used to measure residual nitrate nitrogen in the crop root zone in early spring. The factors that influence the amount of residual nitrate nitrogen in the soil include October-to-April precipitation, soil texture, crop sequence, and repeated manure applications. The PPNT is likely to be most beneficial when corn follows corn on medium- and fine-textured soils and when October-to-April precipitation is normal or below normal. Even in years of above-normal winter precipitation, the test is likely to be beneficial in second-year corn following alfalfa, in continuous corn, and in fields with a history of manure applications. The test is not useful on sandy soils because potential nitrate nitrogen carryover is almost always low in these soils.

Table 4. Nitrogen plant analysis interpretations for common Wisconsin field crops.

CROP	PLANT PART SAMPLED	TIME OF SAMPLING	INTERPRETATION			
			DEFICIENT	LOW	SUFFICIENT	HIGH
			% N			
Alfalfa ^a	Top 6 inches	Early bud	<1.25	1.25–2.50	2.51–3.70	>3.70
Barley, oat, wheat	Top leaves	Boot stage	<1.50	1.50–2.00	2.01–3.00	>3.00
Corn	Ear leaf	Silking	<1.75	1.75–2.75	2.76–3.75	>3.75

^a First crop.

A presidedress soil nitrate test (PSNT) allows adjustments to nitrogen recommendations based on the soil's nitrate content. Soil samples, taken to a depth of 1 foot, are collected after planting is completed. This test measures the amount of nitrogen released from previous legume crops, manure applications, and soil organic matter as well as part of the nitrogen carried over from the previous growing season. The PSNT is a beneficial tool for confirming nitrogen contributions from fall, winter, and spring manure applications and from forage legume crops preceding first-year corn. This test is not recommended on sandy soils. For more information see Extension publication *Soil Nitrate Tests for Wisconsin Cropping Systems* (A3624).

Plant Analysis

Although plant tissue analysis can indicate whether a plant is deficient in nitrogen, it is difficult to detect small differences in nitrogen availability with a tissue sample alone. Many environmental factors such as moisture stress, light intensity, and time of day can

affect the amount of nitrogen in plant tissue. In addition, the amount of total nitrogen (crude protein) in a plant decreases as the plant grows. It is important to specify the stage of growth when sampling a crop for nitrogen analysis. Table 4 gives an approximate interpretation of nitrogen plant analyses for the major agronomic crops grown in Wisconsin. For additional information about plant analysis, see Extension publication *Sampling for Plant Analysis: A Diagnostic Tool* (A2289).

ENVIRONMENTAL EFFECTS

Excessive nitrate in drinking water can cause human and animal health problems. Nitrate and other nitrogen compounds also can hasten deterioration of lakes and streams by promoting excessive growth of weeds and algae. The following recommendations can minimize these adverse environmental effects.

- Use recommended rates of nitrogen fertilizer; give credit to nitrogen from manures and

legumes and to residual nitrate nitrogen as measured by the Wisconsin preplant soil profile nitrate test.

- When possible, time the application of nitrogen fertilizer with nitrogen uptake by the crop, especially on irrigated sandy soils.
- Practice good conservation to minimize erosion losses.
- Maintain a rotation that includes a deep-rooted crop, such as alfalfa.
- Eliminate winter and fall applications of fertilizer.
- Avoid winter application of manure when feasible.
- Locate rural wells as far as possible from farm lots and other areas where manure accumulates.

For additional information on the environmental effects of nitrogen see Extension publication *Nitrate in Wisconsin Groundwater: Sources and Concerns* (G3054).



©1998 University of Wisconsin System Board of Regents and University of Wisconsin-Extension

Author: L.G. Bundy is professor of soil science, College of Agricultural and Life Sciences, University of Wisconsin-Madison and University of Wisconsin-Extension, Cooperative Extension. Produced by Cooperative Extension Publications, University of Wisconsin-Extension.

University of Wisconsin-Extension, Cooperative Extension, in cooperation with the U.S. Department of Agriculture and Wisconsin counties, publishes this information to further the purpose of the May 8 and June 30, 1914 Acts of Congress. An Equal Employment Opportunity/Affirmative Action employer, University of Wisconsin-Extension provides equal opportunities in employment and programming, including Title IX requirements. If you need this material in an alternative format, contact the Office of Equal Opportunity and Diversity Programs or call Cooperative Extension Publications at 608-262-2655.

This publication is available from your Wisconsin county Extension office or from Cooperative Extension Publications, Rm. 170, 630 W. Mifflin St., Madison, Wisconsin 53703. Phone 608-262-3346.



Soil and Applied Phosphorus

E.E. Schulte and K.A. Kelling

Soils generally contain 500–1000 parts per million (ppm) of total phosphorus (inorganic and organic), but most of this is in a “fixed” form that is unavailable for plant use.

Furthermore, soluble phosphorus in fertilizer or other nutrient sources is quickly converted to less-available forms when added to the soil. Although some Wisconsin soils may require large phosphorus additions for best yields, the past use of phosphorus fertilizer and applications of manure have led to unnecessarily high phosphorus levels in many soils. Based on Wisconsin soil test recommendations for field crops, the average soil test phosphorus (44 ppm of extractable phosphorus) for 450,000 Wisconsin soil samples analyzed between 1982 and 1985 was in the excessively high range.

PHOSPHORUS REACTIONS IN SOILS

The two main categories of phosphorus (P) in soils are organic and inorganic. The organic form is found in humus and other organic materials. The inorganic portion occurs in various combinations with iron, aluminum, calcium, and other elements, most of which are not very soluble in water. Both organic and inorganic forms of phosphorus are important sources of phosphorus for plant growth, but their availabilities are controlled by soil characteristics and environmental conditions.

Phosphorus Fixation

One of the unique characteristics of phosphorus is its immobility in soil. Practically all soluble phosphorus from fertilizer or manure is converted in the soil to water-insoluble phosphorus within a few hours after application.

Phosphorus occurs in the soil solution as the negatively charged phosphate ion H_2PO_4^- in acid soils or $\text{HPO}_4^{=}$ in alkaline soils. These ions react readily with iron, aluminum, and manganese compounds in acid soils and with calcium compounds in neutral and alkaline soils. They become strongly attached to the surfaces of these compounds or form insoluble phosphate precipitates. These reactions remove immediately available phosphate ions from the soil solution. Phosphate ions do not leach, as do nitrate ions, even in sandy soils. Studies of highly fertilized, intensively farmed land indicate that the annual loss of phosphorus in drainage water seldom exceeds 0.1 lb/a. The plow layer of the soil usually retains almost all (98–99%) of the applied phosphorus. This means that very little phosphorus moves into or through the subsoil. Acid soils fix more phosphorus than neutral soils; liming acid soils to a pH of 6.0–6.8 increases the availability of both soil and fertilizer phosphorus.

Phosphorus in Organic Matter

The relative amounts of organic and inorganic phosphorus vary considerably. In Wisconsin, organic phosphorus accounts for 30–50% of the total phosphorus in most mineral soils. Decomposition (mineralization) of organic matter converts organic forms of phosphorus to inorganic available forms. As with the mineralization of organic nitrogen, organic phosphorus is released more rapidly in warm, well-aerated soils. This explains why crops grown in cold, wet Wisconsin soils often respond to row-applied phosphorus even though the soil may be well supplied with phosphorus or broadcast phosphorus fertilizer has been added.

ENVIRONMENTAL HAZARDS

Aquatic weeds and algae respond to increasing amounts of phosphorus just as land plants do. Luxurious growth of weeds and algae often results when additional phosphorus enters a lake or stream. Of all plant nutrients, phosphorus is usually the most closely associated with accelerated production of weeds and algae. However, runoff water usually contains very low quantities of soluble phosphorus, even when phosphorus is surface-applied, because of phosphorus immobility in soil. Also, only negligible amounts of phosphorus in soil water percolate through soils. Phosphorus enters surface water mainly by erosion of phosphorus-holding soil particles and organic residues. For these reasons, excessive buildup of soil phosphorus should be avoided, especially in erodible soils. Contact your county Extension agent for further information on recommended practices to minimize phosphorus losses from agricultural land.

FERTILIZER SOURCES OF PHOSPHORUS

Rock phosphate is the original source of nearly all phosphorus fertilizer sold in the United States. Mined rock phosphate is too insoluble to be a useful source of phosphorus for crops, except when very finely ground and when soil pH is below 6.0. During the manufacture of fertilizer, insoluble rock phosphate is treated with an acid to convert it to more-available superphosphate or ammonium phosphate. This process neutralizes the acid; application of phosphate fertilizer results in very little residual acidity when it is applied to the soil. The



common phosphate fertilizers, listed in Table 1, are seldom applied alone in Wisconsin. Usually they are manufactured or blended with nitrogen, potassium, or both to form a mixed fertilizer such as 6-24-24 or 9-23-30.

Orthophosphate versus Polyphosphate

Sources of phosphorus containing the H_2PO_4^- or HPO_4^{2-} ions are called orthophosphates. Polyphosphates contain a mixture of orthophosphate and some long-chain phosphate ions such as pyrophosphate, $(\text{HP}_2\text{O}_7)_3^-$. Commercially produced polyphosphate contains approximately 50% orthophosphate and 50% long-chain phosphate compounds.

Claims that polyphosphates are superior to orthophosphates exaggerate their ability to partially chelate or combine with certain micronutrients and hold them in an available form. Research has not demonstrated that this difference improves yields or increases nutrient uptake in most soils. Polyphosphate ions react with soil moisture to form orthophosphates relatively rapidly (1–2 weeks). On almost all soils, orthophosphate and

polyphosphate fertilizers are equally effective.

Effect of Water Solubility

The amount of water-soluble phosphorus in the different sources of available phosphorus varies considerably (Table 1). When phosphorus is broadcast and incorporated or when it is topdressed on forages, the amount of water solubility makes little or no difference. University of Wisconsin research shown in Table 2 illustrates that the differences in water solubility among concentrated superphosphate (85% soluble), ammoniated superphosphate (60% soluble), and monoammonium phosphate (92% soluble) did not influence yields. Increasing the amount of water-soluble phosphorus above 60% did not increase yields. All commonly used phosphorus fertilizers presently sold in Wisconsin (except rock phosphate) contain at least 85% water-soluble phosphorus.

Liquid versus Dry Phosphate

Compared to conventional dry fertilizers, liquid fertilizers are easier to handle, mix, and apply. Despite claims to the contrary, research has shown that liquid phosphate does not improve fertilizer phosphorus availability or recovery. It is the soil interactions that control phosphorus uptake, not the physical form of the fertilizer applied.

Rock Phosphate versus Superphosphate

Rock phosphate is sometimes recommended instead of superphosphate for building up the “reserve” level of phosphate in soil. The phosphorus in rock phosphate becomes available only when the soil is acid (below pH 5.5), and therefore its use by Wisconsin dairy farms is not recommended. The pH should be about 6.8 for high-quality alfalfa and at least 6.0–6.2 for most other agronomic crops. Research in the 1950s clearly demonstrated that rock phosphate is not an effective phosphorus source in most soils.

Table 1. Fertilizer sources of phosphorus.

NAME OF FERTILIZER	CHEMICAL FORMULA	FERTILIZER ANALYSIS	WATER SOLUBILITY
		EQUIVALENT N-P ₂ O ₅ -K ₂ O	
		%	
Ammonium polyphosphate	$\text{NH}_4\text{H}_2\text{PO}_4 + (\text{NH}_4)_3\text{HP}_2\text{O}_7$	10-34-0	100
Liquid		15-62-0	100
Dry			
Diammonium phosphate	$(\text{NH}_4)_2\text{HPO}_4$	18-46-0	>95
Monoammonium phosphate	$\text{NH}_4\text{H}_2\text{PO}_4$	11-48-0	92
Ordinary superphosphate	$\text{Ca}(\text{H}_2\text{PO}_4)_2 + \text{CaSO}_4$	0-20-0	85
Rock phosphate	$3\text{Ca}_3(\text{PO}_4)_2 \cdot \text{CaF}_2$	0-32-0	<1
Triple superphosphate	$\text{Ca}(\text{H}_2\text{PO}_4)_2$	0-46-0	87



METHOD OF APPLICATION

Plants need relatively large amounts of phosphorus early in the life cycle. Root development is limited in cool, wet soils, and very little phosphorus is released from soil organic matter. Some studies have found banded phosphorus to be nearly twice as efficient as broadcast phosphorus in cold soils. In well-drained, fertile soils that warm up early in the spring, however, row and broadcast applications are often equally effective. Since phosphorus moves very little from the point of application, place the row fertilizer 1–2 inches to the side and below the seed. Be careful not to apply excessive rates of starter fertilizer, particularly when using highly ammoniated fertilizers on high-pH soils. Optimum starter rates depend on soil test levels, the distance between fertilizer and seed, soil texture, and the salt index of the fertilizer applied.

DIAGNOSTIC TECHNIQUES

Deficiency Symptoms

The leaves of phosphorus-deficient plants most often appear dark bluish green, frequently with tints of purple or bronze. On corn, purpling occurs around the margins of the lower leaves, and the plant is short and dark green. Some corn hybrids exhibit a purple tinge on the lower stalk of young plants, a condition that can be confused with phosphorus deficiency. Reddening of corn leaves and stalks in the fall is not an indication of phosphorus deficiency, but of a process that occurs naturally as corn matures. Phosphorus-deficient alfalfa is stunted and dark bluish green, but purpling does not occur.

Soil Analysis

Many methods exist for measuring available phosphorus in soils. The Bray P_1 test, developed at the University of Illinois, is common in Wisconsin and throughout most of the Midwest. The interpretation of this test depends on the soil type and intended crop. See Extension publication A3030, *Optimum Soil Test Levels for Wisconsin*, for details. In general, soil-test phosphorus should be 10–30 ppm for field crops and somewhat higher for potato and some vegetable crops, including cabbage, carrot, melons, and tomato. Recommendations for phosphorus fertilizer vary with crop species, yield goal, and soil type. If soil phosphorus is below the optimum level, the amount of phosphate recommended will permit a gradual buildup (over 5–8 years) of the available supply. If soil phosphorus is high, the amount recommended will be less than the amount removed in the harvested portion of the crop, allowing some decrease in the soil test. For excessively high tests, elimination of part or possibly all of the phosphorus fertilizer allows the soil test to drop to the optimum range.

Table 2. Effect of various sources of row-applied phosphorus on the yield of corn (Arlington, WI).

FERTILIZER GRADE	SOURCE OF PHOSPHORUS IN COMMERCIAL 6-24-24 ^a	WATER SOLUBILITY	YIELD OF CORN ^b
		%	bu/a
Control	No phosphorus applied	—	96
6-24-24	Ammoniated superphosphate	60	109
6-24-24	Concentrated superphosphate	85	112
6-24-24	Monoammonium phosphate	92	112

^aThe 6-24-24 was applied at a rate of 167 lb/a to supply 40 lb/a of P_2O_5 (17 lb/a P).

^bThe differences in yield between the various sources of phosphorus are not significant.

Plant Analysis

Analysis of plant tissue gives a good indication of the phosphorus nutrition of the plant. Because phosphorus levels in the plant change with age and plant part, it is important to indicate the stage of maturity when sampling the plants. Table 3 interprets phosphorus levels for the major Wisconsin field crops. See Extension publication A2289, *Plant Analysis: A Diagnostic Tool*, for additional information.

ADDITIONAL INFORMATION

These publications in the *Understanding Plant Nutrients* series are available from your county Extension office:

Soil and Applied Boron	(A2522)
Soil and Applied Calcium	(A2523)
Soil and Applied Chlorine	(A3556)
Soil and Applied Copper	(A2527)
Soil and Applied Iron	(A3554)
Soil and Applied Magnesium	(A2524)
Soil and Applied Manganese	(A2526)
Soil and Applied Molybdenum	(A3555)
Soil and Applied Nitrogen	(A2519)
Soil and Applied Phosphorus	(A2520)
Soil and Applied Potassium	(A2521)
Soil and Applied Sulfur	(A2525)
Soil and Applied Zinc	(A2528)

Table 3. Phosphorus plant-analysis interpretations for common Wisconsin field crops.

CROP	PLANT PART SAMPLED	TIME OF SAMPLING	INTERPRETATION				
			DEFICIENT	LOW	SUFFICIENT	HIGH	EXCESSIVE
			————— % —————				
Alfalfa	Top 6 inches	Bud	<0.20	0.20–0.25	0.26–0.70	0.71–1.00	>1.00
Corn	Whole plant	6–16 in	<0.20	0.20–0.39	0.40–0.60	0.61–1.20	>1.20
Corn	Earleaf	Silking	<0.16	0.16–0.24	0.25–0.50	0.51–0.80	>0.80
Oat	Top leaves	Boot stage	<0.15	0.15–0.20	0.21–0.50	0.51–0.75	>0.75
Soybean	First trifoliolate	Early flower	<0.15	0.15–0.25	0.26–0.50	0.51–0.80	>0.80

Copyright © 1996 University of Wisconsin-System Board of Regents and University of Wisconsin-Extension, Cooperative Extension

Authors: E.E. Schulte is professor emeritus and K.A. Kelling is professor of soil science, College of Agricultural and Life Sciences, University of Wisconsin-Madison and University of Wisconsin-Extension, Cooperative Extension. The authors wish to thank L.M. Walsh, professor emeritus of soil science, University of Wisconsin-Madison and University of Wisconsin-Extension, Cooperative Extension, for contributions from an earlier edition of this publication and P.P. Motavalli for editorial assistance. Produced by Cooperative Extension Publications, University of Wisconsin-Extension.

University of Wisconsin-Extension, Cooperative Extension, in cooperation with the U.S. Department of Agriculture and Wisconsin counties, publishes this information to further the purpose of the May 8 and June 30, 1914 Acts of Congress; and provides equal opportunities in employment and programming. If you need this information in an alternative format, contact the Office of Equal Opportunity and Diversity Programs or call Cooperative Extension Publications at 608-262-2655.

This publication is available from your Wisconsin county Extension office or from Cooperative Extension Publications, Rm. 170, 630 W. Mifflin St., Madison, Wisconsin 53703. Phone 608-262-3346.



Soil and Applied Potassium

E.E. Schulte and K.A. Kelling

Soils commonly contain over 20,000 parts per million (ppm) of total potassium (K). Nearly all of this is a structural component of soil minerals and is unavailable to plants. Plants can use only the exchangeable potassium on the surface of soil particles and potassium dissolved in the soil water. This often amounts to less than 100 ppm.

Large quantities of potassium are removed with harvests of such plants as alfalfa, certain vegetables, other forages, and corn silage. Grain and seed harvests remove much less potassium. Most Wisconsin soils need relatively large quantities of applied potassium because of removal by crops and because Wisconsin soils have little native exchangeable potassium.

POTASSIUM REACTIONS IN SOILS

Forms of Soil Potassium

The three forms of soil potassium are unavailable, slowly available or fixed, and readily available or exchangeable potassium.

Unavailable soil potassium is contained within the crystalline structure of micas, feldspars, and clay

minerals. Plants cannot use the potassium in these insoluble forms. Over long periods, these minerals weather or break down, releasing their potassium as the available potassium ion (K^+). This process is far too slow to supply the full potassium needs of field crops. However, trees and long-term perennials obtain a substantial portion of potassium from the weathering of minerals containing potassium.

Slowly available potassium is trapped between the layers or plates of certain kinds of clay minerals. This is sometimes called fixed potassium. Plants cannot use much of the slowly available potassium during a single growing season. However, the supply of fixed potassium largely determines the soil's ability to supply potassium over extended periods of time. The red soils of eastern Wisconsin are examples of soils that contain significant amounts of slowly available potassium.

Readily available potassium is that which is dissolved in soil water or held on the surface of clay particles. Dissolved potassium levels in the soil water are usually 5–10 ppm. Plants absorb dissolved potassium readily, and as soon as the concentration of potassium in the soil solution drops,

more is released into the solution from the exchangeable forms. Most soil tests for available potassium measure the readily available forms but not the unavailable and slowly available forms.

Movement of Soil Potassium

Since clay and organic matter particles hold potassium ions in an exchangeable or available form, potassium does not leach from silty or clayey soils. Some leaching may take place in very sandy soils because sandy soils do not contain enough clay to hold the potassium.

Organic matter particles hold most positively charged nutrients tightly. Potassium is an exception because the attraction between potassium ions and organic matter particles is relatively weak. Consequently, some potassium leaches from organic soils (peats and mucks). Loss of potassium by leaching is one reason sandy and organic soils often test relatively low in available potassium, especially when tested in the spring. These soils require precise annual potassium applications, since it is not possible to build up high potassium reserves.

Table 1. Fertilizer sources of potassium.

NAME OF FERTILIZER	CHEMICAL FORMULA	FERTILIZER ANALYSIS EQUIVALENT N-P ₂ O ₅ -K ₂ O	SALT INDEX
		%	
Potassium chloride (muriate of potash)	KCl	0-0-60 to 0-0-62	116
Potassium magnesium sulfate	K ₂ SO ₄ •2MgSO ₄	0-0-22	43
Potassium nitrate	KNO ₃	13-0-44	74
Potassium sulfate	K ₂ SO ₄	0-0-50	46

Table 2. Potassium plant-analysis interpretations for common Wisconsin field crops.

CROP	PART SAMPLED	TIME OF SAMPLING	INTERPRETATION				
			DEFICIENT	LOW	SUFFICIENT	HIGH	EXCESSIVE
			%				
Alfalfa	Top 6 inches	Bud	<1.8	1.8–2.4	2.5–3.8	3.9–4.5	>4.5
Corn	Earleaf	Silking	<1.3	1.3–1.7	1.8–2.3	2.4–2.9	>2.9
Oat	Top leaves	Boot stage	<1.3	1.3–1.5	1.6–2.5	2.6–3.0	>3.0
Soybean	First trifoliate	Early flower	<1.3	1.3–1.7	1.8–2.5	2.6–4.5	>4.5

FERTILIZER SOURCES OF POTASSIUM

The most common potassium fertilizer for use on field crops is potassium chloride, or muriate of potash. Both red- and white-colored potash are often available. (See Table 1 for the primary fertilizer sources of potassium.) These materials are equivalent as sources of potassium. The red color is due to iron impurities that have no effect on the availability of potassium or other nutrients. Most of the U.S. supply of potassium chloride is mined from vast underground deposits in Saskatchewan, although some is also mined in the western U.S. This is the least expensive source of potassium and is as effective as the other materials for most cropping situations, except where very high rates are to be used, where the burning quality of tobacco is important, or where the solids content of potatoes are of primary concern. When high rates of potassium are needed or when soil salinity is a problem, potassium fertilizer applications should be split or materials with a lower salt index, such as potassium sulfate (K_2SO_4) or potassium magnesium sulfate ($K_2SO_4 \cdot 2Mg SO_4$), should be used.

DIAGNOSTIC TECHNIQUES

Deficiency Symptoms

On corn, soybean, and other field crops, potassium deficiency appears as a yellowing or scorching of the margins of older leaves. In alfalfa, the deficiency appears as whitish-grey spots along the outer margin of the recently matured and older leaflets. As the deficiency becomes more severe, the affected area increases and the leaves or leaflets may become completely yellow and/or drop off. Because potassium is a very mobile element within the plant, deficiency appears on the older leaves first.

Soil Analysis

Available potassium is estimated by measuring the solution and exchangeable potassium. Extension publication A3030, *Optimum Soil Test Levels for Wisconsin*, provides an interpretation of the exchangeable or available potassium test for Wisconsin soils. In general, available potassium should be 60–120 ppm for most field crops and somewhat higher for potato and some vegetable crops, including cabbage, carrot, melons, and tomato. Recommendations for potassium fertilizer vary with crop species, yield goal, and soil type. If soil tests are below

optimum levels, the amount of potash recommended will permit a gradual buildup (over 5–8 years) of the available supply. If soil potassium is high, the amount recommended will be less than the amount removed in the harvested portion of the crop, allowing some decrease in the soil test. For excessively high tests, elimination of part or possibly all of the potassium fertilizer allows the soil test to drop to the optimum range.

Plant Analysis

Critical concentrations of potassium for economically important crops are fairly well known. Like nitrogen, the amount of potassium in the plant decreases as it matures; it is therefore important to know the plant's stage of growth to properly interpret the results of potassium analysis. Also, the potassium concentration usually decreases from top to bottom of the plant, so the portion of the plant sampled affects the interpretation as well. Interpretations of potassium levels in the leaf tissue of several major Wisconsin field crops are given in Table 2. See Extension publication A2289, *Sampling for Plant Analysis: A Diagnostic Tool*, for additional information.

Authors: E.E. Schulte and K.A. Kelling are professors of soil science, College of Agricultural and Life Sciences, University of Wisconsin-Madison and University of Wisconsin-Extension, Cooperative Extension. The authors wish to thank L.M. Walsh, professor of soil science, University of Wisconsin-Madison and University of Wisconsin-Extension, Cooperative Extension, for contributions from an earlier edition of this publication and P.P. Motavalli for editorial assistance. Produced by Cooperative Extension Publications, University of Wisconsin-Extension.

University of Wisconsin-Extension, Cooperative Extension, in cooperation with the U.S. Department of Agriculture and Wisconsin counties, publishes this information to further the purpose of the May 8 and June 30, 1914 Acts of Congress. An Equal Employment Opportunity/Affirmative Action employer, University of Wisconsin-Extension provides equal opportunities in employment and programming, including Title IX requirements.

This publication is available from your Wisconsin county Extension office or from Cooperative Extension Publications, Rm. 245, 30 N. Murray St., Madison, Wisconsin 53715. Phone 608-262-3346.

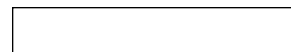

Plant Nutrient Deficiency Symptoms

Plants that are not supplied with adequate amounts of one of the essential plant nutrients often develop specific visual characteristics that can be associated with a deficiency of that nutrient. These specific visual characteristics or nutrient deficiency symptoms are one method of identifying nutrient deficiencies in plants.

When visual symptoms are used to diagnose plant problems, it is essential to recognize that nutrient deficiencies are only

one of many factors that can affect the overall appearance of plants. Other factors such as drought stress and other weather-related events, plant diseases, insect damage, nutrient toxicities, and injury from fertilizer or pesticide applications can also influence plant characteristics and appearance.

Nutrient deficiency symptoms in several of the major agricultural crops in Wisconsin are described below.

Crop	Nutrient	Deficiency Symptoms
Corn	Nitrogen	Yellowing or "firing" of the lower leaves. Yellowing starts at the tip of the leaf and proceeds up the midrib. Leaf margins may remain green.
	Phosphorous	Purpling or reddening along the lower leaves early in the growing season. Discoloration usually disappears before corn reaches 18 to 24 inches in height.
	Potassium	Yellowing or browning of the lower leaves. Yellowing or browning occurs along the margin or edge of the leaf. Midrib will remain green.
	Sulfur	Plants are stunted and have an overall lighter or yellowish color. Symptoms are not localized and the entire plant is spindly and pale in color. Yellowing between veins in leaves is sometimes apparent. Deficiency is most likely on soils with low organic matter located away from industrial areas.
	Zinc	Broad bands of bleached or yellow tissue on each side of the midrib beginning at the base of the leaf. Midrib and leaf margins remain green. Zinc deficiency is the most common micronutrient deficiency in corn, and is most likely on light colored eroded or scalped soils, especially sands. High pH, medium textured soils can also be zinc deficient.
Alfalfa	Potassium	White spots around the outer edges of lower leaves. With severe deficiency, size and number of spots increase, and leaves eventually become yellow and die. Lower leaves may drop off of plant.
	Boron	Top leaves turn yellow with a reddish cast. Bunched or bushy appearance of plants. Growing tips of plants are yellow and severely retarded while side stems and lower leaves remain green. Boron deficiency is the major micronutrient problem in alfalfa production, and is most likely on soils with low organic matter content. Deficiency is promoted by dry weather.
	Phosphorus	No distinct symptoms except for stunted growth. In extreme deficiency, plants may develop a bluish-green color.
	Sulfur	Stunted plants, light yellow color, spindly growth. Deficiency is most likely on sandy soils with low organic matter contents.

Crop	Nutrient	Deficiency Symptoms
Soybeans	Potassium	Yellow bands along edges and tips of leaves. Center of leaf may remain green after leaf edges are dead. Grain is wrinkled and misshapen.
	Manganese	Areas between leaf veins turn pale green and then yellow. Veins remain green and in sharp contrast to pale inter-veinal areas. Deficiency is most likely on high pH soils.
Potato	Nitrogen	Pale green color, edges of leaflets roll upward. In severe deficiency, leaf margins lose green color and curl upward at the edges.
	Potassium	Bronzing of leaf surfaces and edges of leaves turn brown.

USING PLANT ANALYSIS AS A DIAGNOSTIC TOOL^{1/}

K.A. Kelling, S.M. Combs, and J.B. Peters^{2/}

The information provided through plant analysis helps farmers with decisions on fertilizer effectiveness, the need for additional nutrients, and planning fertilizer programs for future years. If used properly, plant analysis can be an important guide to efficient crop production because it provides a nutritional profile of the growing plant at the time that the sample was taken.

Essential Elements

Plants require 17 elements for normal vegetative growth and reproduction. In addition, there are some elements that improve plant growth in some situations but are not essential. Table 1 shows the main function of the essential elements and their primary sources. Different amounts of each element are required by different plant species. Plant growth is restricted when: 1) not enough of one or more elements is present; 2) too much of one or more elements is present, including toxic levels of nonessential elements such as aluminum, arsenic, selenium, or sodium; 3) the levels of one or more elements are adequate but out of balance with other elements.

The first result of nutrient deficiency, toxicity, or imbalance is a reduction in plant growth. If the condition persists, visible symptoms of deficiency or toxicity appear, and plant yield is reduced even further. A nutrient deficiency or imbalance may result in a yield reduction without showing visible symptoms but is detectable by plant analysis.

^{1/} Presented at the Fertilizer Dealer Meetings, November 28 to December 7, 2000.

^{2/} Extension Soil Scientist and Professor, Dept. of Soil Science, Univ. of Wisconsin-Madison; Director, UW-Madison Soil and Plant Analysis Lab; Director; Soil and Forage Analysis Lab,

Marshfield, WI.

Table 1. Concentration, function, and primary source of essential plant elements.

Element (chemical symbol)	Approximate concentration in plants	Main function in plants	Primary sources
<u>Essential plant nutrients</u>			
Carbon (C)	45%	Part of all organic compounds	Carbon dioxide in air
Hydrogen (H)	6%	Forms main structural components	Water
Oxygen (O)	43%	Forms main structural components	Water, air
Nitrogen (N)	1-6%	Components of proteins, chlorophyll, nucleic acids	Soil organic matter; microbial fixation of atmospheric nitrogen (legumes)
Phosphorus (P)	0.05-1%	Energy transfer; metabolism, nucleic acids, phospholipids	Soil organic matter, soil minerals
Potassium (K)	0.3-6%	Protein synthesis; translocation of carbohydrates; enzyme activation; universal cation	Soil minerals
Calcium (Ca)	0.1-3%	Structural component of cell walls; cell elongation; affects cell permeability	Soil minerals, limestone
Magnesium (Mg)	0.05-1%	Component of chlorophyll; enzyme activator; metabolism; cell division	Soil minerals; dolomitic limestone
Sulfur (S)	0.05-1.5%	Constituent of proteins; involved in respiration and nodule formation	Soil organic matter; rainwater
Iron (Fe)	10-1000 ppm	Chlorophyll synthesis; oxidation-reduction reactions; enzyme activator	Soil minerals; soil organic matter
Manganese (Mn)	5-500 ppm	Oxidation-reduction reactions; nitrate reduction; enzyme activator	Soil minerals
Copper (Cu)	2-50 ppm	Enzyme activator; nitrate reduction; respiration	Soil minerals; soil organic matter

Table 1. (continued).

Element (chemical symbol)	Approximate concentration in plants	Main function in plants	Primary sources
<u>Essential plant nutrients (continued)</u>			
Zinc (Zn)	5-100 ppm	Enzyme activator; regulates pH of cell sap	Soil minerals; soil organic matter
Boron (B)	2-75 ppm	Cell maturation and differentiation; translocation of carbohydrates	Soil organic matter; tourmaline
Molybdenum (Mo)	0.01-10 ppm	Nitrate reduction; fixation of atmospheric nitrogen by legumes	Soil organic matter; soil minerals
Chlorine (Cl)	0.05-3%	Photochemical reactions in photosynthesis	Rainwater
Nickel (Ni)	0.1-10 ppm	Metal component of urease; seed fertility	Soil minerals
<u>Enhancing or beneficial nutrients</u>			
Sodium (Na)	0.05-2%	Influences mesophyll chloro- plasts of some C ₄ halophytes; substitutes for K; increases cell expansion	Soil minerals
Silicon (Si)	0.1-10%	May affect spikelet fertility of some species; contributes to cell wall stability	Soil minerals
Cobalt (Co)	0.01-10 ppm	Nitrogen fixation, component of vitamin B ₁₂	Soil minerals
Selenium (Se)	2-1000 ppm	Component of enzyme co- factor responsible for peroxide in animals; essential for animals; insect defense	Soil minerals
Aluminum (Al)	10-1000 ppm	May alleviate toxicities from other elements	Soil minerals

What is Plant Analysis

Plant analysis is the quantitative determination of many of the essential nutrients in plant tissue. Carbon, hydrogen, and oxygen are not analyzed routinely because they come from air or water and plant analysis is not helpful for these elements. Chlorine is normally sufficient under field conditions, but it may become excessive in saline soils. It is usually analyzed in special cases only. Similarly, molybdenum and nickel deficiency or toxicity are rare, and these elements are not analyzed routinely. Thus, plant analysis usually refers to analysis of nitrogen (N), phosphorus (P), potassium (K), calcium (Ca), magnesium (Mg), sulfur (S), iron (Fe), manganese (Mn), copper (Cu), zinc (Zn), and boron (B). Aluminum (Al) and sodium (Na) are sometimes included even though they are not essential elements. Aluminum can be toxic in very acid soils, and sodium can improve the quality of some crops such as beets and celery.

Plant analysis is distinguished from tissue testing in that it is a quantitative laboratory analysis, whereas tissue testing refers to semi-quantitative or quantitative “quick” tests of crushed tissue or plant sap carried out in the field for trouble-shooting purposes.

The general relationship between plant tissue nutrient levels and crop growth is shown in Figure 1. When a nutrient is deficient, addition of that nutrient results in increased crop growth and usually an increase in the concentration of that element in the plant. As the level of the deficient nutrient increases, crop growth increases until some maximum yield is reached. Further additions of the element will cause the concentration of that element in the plant to rise more rapidly because it is not being diluted by added dry matter accumulation. Eventually, toxicity of that element may occur.

Uses of Plant Analysis

Plant analysis has proven useful in confirming nutrient deficiencies, toxicities or imbalances, identifying “hidden hunger,” evaluating fertilizer programs, determining the availability of elements not tested for by other methods, and studying interactions among nutrients.

Determining nutritional problems — One of the major uses of plant analysis is troubleshooting crop problems. Plant analysis defines nutrient problems more precisely than does an examination of deficiency symptoms, soil tests, or quick tissue tests. In addition to confirming suspected deficiencies, plant analysis can also detect toxicities or hidden deficiencies when visible symptoms are not evident. The second most common use is crop monitoring to evaluate potential nutritional problems while they can still be corrected or so they can be avoided in subsequent seasons.

Evaluating fertilizer programs — Scientists and others use plant analysis to study uptake from fertilizer or other nutrient sources and to evaluate different methods and times of fertilizer application. Farmers can also use plant analysis to determine whether their fertilizer program is performing according to expectations. Adding nutrients is no guarantee that they have been utilized as other factors may restrict uptake. Plant analysis can establish treatment effectiveness.

Determining nutrient availability where soil tests are not available — Most laboratories routinely test soils for lime needs, phosphorus, and potassium. Some have optional tests for calcium, magnesium, and some of the minor elements. However, reliable soil tests have not been developed for all of the elements. Furthermore, a test for iron developed in one state is not necessarily applicable to the soils of another state until the test has been calibrated for the soils in that state. Plant analysis can be particularly advantageous in determining the availability of nutrients for which there are no reliable soil tests, or for those areas where soil test calibration has not been done.

Deficiencies of most micronutrients and sulfur are identified more accurately by plant analysis than by soil test. The soil test commonly used for sulfur, for example, measures only the amount of sulfate-sulfur present in the sampled area at that point in time. It does not include possible contributions from other sources such as rainfall. A high sulfur soil test indicates adequate sulfur is present, but a low test may mean either the sulfur is not there or it was not measured by the soil test. Plant analysis gives an accounting of all of the sulfur available to the plant.

Studying nutrient interactions — Plant analysis helps detail the relationships among essential elements. This use may have rather limited applicability for most routine users.

Plant Analysis Complements Soil Testing

Sometimes adequate nutrient levels may be present in the soil, but because of other problems—such as cool temperatures at planting, insect feeding, or root damage—inadequate amounts of nutrients get into the plant. Plant analysis along with soil tests can help pinpoint the problem. For example, plant analysis of corn ear leaf samples from central Wisconsin may show high levels of manganese present, but the soil analysis identifies the actual problem is very acidic soil resulting in excessive manganese availability.

Soil tests normally are calibrated for the average depth of plowing. If a subsoil is high in a particular nutrient, the subsoil contribution will go undetected unless a subsoil sample is also analyzed. A plant analysis will not tell how much of the nutrient in the plant came from the subsoil, but it will measure the integrated effect of the entire root volume, which may include several cubic feet of soil.

The results of plant analysis alone cannot be used to make fertilizer recommendations. Although plant analysis can provide substantial additional information, plant samples should be accompanied by soil samples taken from the same area as the plants. If the plant and soil samples are taken from an abnormal area of a field, the results are applicable to that area only. Unless a field is sampled in detail, the soil sample accompanying a plant sample usually is not very representative of the entire field. Emergency recommendations for an abnormal area in a field can be made from soil and plant analyses, but field-scale recommendations should be based on appropriate soil sampling and analysis (see Extension Publication #A2100, “Sampling Soils for Testing”).

Limitations of Plant Analysis

Interpretation difficulties — In general, good relationships can be developed between soil nutrient supply, nutrient levels in the plant, and crop yield for a given plant part, time of sampling, and location in any one year. However, differences in location, variety, time, and management often cause variations in these relationships and make them difficult to interpret. Nutrient levels in plants differ depending on the plant part sampled, stage of maturity, hybrid, and climatic conditions. Interpretations of plant analysis must take these factors into consideration. For this reason, most plant analysis interpretations are based on a specific plant part sampled at a definite stage of development. Greater detail on plant sampling for tissue analysis is provided in Extension Publication A2289 “Sampling for Plant Analysis.”

For corn, the ear leaf at silking is most commonly used for diagnostic analysis. In most situations, this is too late for remedial treatment. The results of the analysis, then, can only be used to guide future management decisions. In many cases, it may be possible to identify nutrient disorders at an earlier stage of crop development if plants from a normal growing field at the same growth stage are also analyzed for comparison. The normal/abnormal

comparison is especially important for plants in early growth stages since sampling the entire plant tends to mask the differences in key plant parts, or for specialty crops that may not have an adequate calibration database developed.

Interrelationship of other factors — Interpreting plant analysis assumes that the chemical composition of the plant reflects its nutrient supply in relation to the growth of the crop. There are situations, however, when the nutrient concentrations in the plant are not the primary factor responsible for the amount of plant growth obtained. For example, any factor that limits growth may cause non-limiting nutrients to accumulate at higher than normal concentrations in the plant. In this case, there is not necessarily a direct relationship between nutrient supply and plant growth.

Progressive deficiencies — Plant analysis usually detects only the one element that most inhibits plant growth. Rarely are two or more elements acutely deficient at the same time. A corn plant, for example, may be deficient in K, but because K is limiting growth, there may be sufficient P for the reduced amount of dry-matter production even if the soil P supply is low. However, when K is added as a remedial treatment, dry-matter production increases sharply; then P becomes deficient. Nitrogen stress, on the other hand, can limit the uptake of phosphorus and some of the micronutrients to the extent that they appear to be “low.”

Secondary deficiencies — If plant growth is limited because of something other than a nutrient shortage (i.e., insect feeding or lack of water), the nutrient deficiency symptoms expressed may be a secondary effect. Adding more nutrient in this case will not increase nutrient uptake or plant growth.

Sample contamination — Contamination of a plant sample with soil particles or pesticide residue can lead to erroneously high results for iron, aluminum, manganese, zinc, or copper. Washing the sample to remove contamination can introduce other contaminants if a detergent or tap water are used. Appreciable potassium can be lost by washing.

Sample deterioration — Decomposition of a plant sample before it reaches the laboratory will result in a loss of carbon (as CO₂ through respiration and microbial activity) and the concomitant increased concentration of most other elements, thereby giving erroneously high readings. This can be prevented by refrigerating the sample until it is delivered to the laboratory or air-drying to 15 to 25% moisture.

Interpretation of Plant Analyses

Critical value and sufficiency range approaches — For most diagnostic purposes, plant analyses are interpreted on the basis of “critical or sufficiency levels” for each nutrient. The critical level has been defined as that concentration below which yields decrease or deficiency symptoms appear. For many nutrients, yield decreases even before visible deficiency symptoms are observed. Because the exact concentration of a

nutrient below which yields decline is difficult to determine precisely, some define the critical level as the nutrient concentration at 90 or 95% of maximum yield.

The nutrient composition of a plant changes as the plant matures and with the portion of the plant sampled; therefore, critical levels are defined for a specific plant part at a specified stage of maturity. For corn, the ear leaf from the period from tasseling to silking is most commonly used. For most crops, there is an optimal range of concentration over which yield will be maximized rather than a single point. Growers, therefore, usually strive for operating in the sufficiency range that corresponds to the yield plateau illustrated in Figure 1. Most nutrients have fairly broad sufficiency ranges.

Nutrient ranges representing deficient, low, sufficient, high, and excessive concentrations for corn and alfalfa used by the University of Wisconsin Soil and Plant Analysis Lab. are given in Table 2. For some nutrients, excessive nutrient levels have not been well-defined because growth is not depressed by excessive uptake. These ranges are useful guidelines for interpreting plant analyses, but they must not be used dogmatically. Knowledge of hybrid requirements, unusual soil or climatic conditions, or other extenuating information should be considered.

DRIS or nutrient ratio approach — The Diagnosis and Recommendation Integrated System (DRIS) simultaneously considered nutrients on a ratio basis in relation to crop growth. The DRIS approach to interpreting the results of plant analysis involves creating a database from the analysis of thousands of samples of a specific crop. The nutrient ratios corresponding to the highest yielding portion of the population are established as the standard (norms) and used as the basis for comparison. A ratio of plant nutrient concentrations by itself cannot be used to diagnose plant problems, but combinations of different nutrient ratios can be combined mathematically to determine what nutrients are most likely to limit yield. The results of such calculations are the “DRIS indices.”

An index of 0 is considered optimum; however, although finer-tuning may be possible, DRIS indices are normally calibrated so that those within the range of about -15 to +25 are considered normal and in balance. A DRIS index less than -25 indicates a likely deficiency, whereas those between -15 and -25 represent a possible deficiency. Values greater than +100 may be an indication of possible nutrient excess. The greater the magnitude of the nutrient index, either positive or negative, the more likely that element is out of balance in the plant.

The principal advantages of the DRIS system are that stage of maturity, plant part, and cultivar are less important than they are for the critical level or sufficiency range approaches to interpreting plant analyses. Thus, by using DRIS as a interpretative approach, it is possible to sample alfalfa at the pre-bud stage and obtain meaningful results, rather than waiting until first flower.

Table 2. Interpretive ranges for plant nutrients used by the University of Wisconsin Soil and Plant Analysis Lab.

Nutrient	Tissue nutrient interpretative level				
	Deficient	Low	Sufficient	High	Excessive
<u>Corn ear leaf at tasseling to silking</u>					
N, %	<1.75	1.75-2.76	2.76-3.75	>3.75	--
P, %	<0.16	0.16-0.24	0.25-0.50	>0.50	--
K, %	<1.25	1.25-1.74	1.75-2.75	>2.75	--
Ca, %	<0.10	0.10-0.29	0.30-0.60	0.61-0.90	>0.90
Mg, %	<0.10	0.10-0.15	0.16-0.40	>0.40	--
S, %	<0.10	0.10-0.15	0.16-0.50	>0.50	--
Zn, ppm	< 12	12-18	19-75	76-150	>150
B, ppm	<2.0	2.0-5.0	5.1-40.0	41-55	>55
Mn, ppm	< 12	12-18	19-75	>75	--
Fe, ppm	< 10	10-49	50-250	251-350	>350
Cu, ppm	--	<3	3-15	16-30	>30
<u>Top 6 inches of alfalfa at first flower</u>					
N, %	<1.25	1.25-2.50	2.51-4.00	>4.00	--
P, %	<0.20	0.20-0.25	0.26-0.45	>0.45	--
K, %	<1.75	1.75-2.25	0.26-3.40	3.41-4.25	>4.25
Ca, %	--	<0.70	0.70-2.50	>2.50	--
Mg, %	<0.20	0.20-0.25	0.26-0.70	>0.70	--
S, %	<0.20	0.20-0.25	0.26-0.50	>0.50	--
Zn, ppm	--	<20	20-60	60-300	>300
B, ppm	< 20	20-25	26-60	>60	--
Mn, ppm	< 15	15-20	21-100	101-700	>700
Fe, ppm	--	<30	30-250	>250	--
Cu, ppm	--	<3.0	3.0-30.0	>30.0	--

DRIS norms are not available for all crops and some users of the DRIS system tend to interpret the results too dogmatically. Some regard every negative index as representing a deficiency and pay no attention to positive indices. Since not all of the nutrient norms used to develop DRIS indices have been evaluated under field conditions, experience has shown that the evaluations should not be made disregarding nutrient concentrations altogether. The University of Wisconsin recommends that the two interpretative approaches be used together.

PASS — The Plant Analysis with Standardized Scores (PASS) was developed at the University of Wisconsin to combine the strengths of the sufficiency range (SR) and DRIS methods. The SR provides easily interpreted, categorical, independent nutrient indices. The DRIS gives difficult to calculate, easily interpreted, numerical, dependent nutrient indices, and a ranking of the relative deficiencies. The strengths of the SR are the weaknesses of the DRIS and vice-versa. The PASS system combines an independent nutrient section and a dependent nutrient section. Both types of indices are expressed as a standardized score and can be combined to make more effective interpretations. Research has demonstrated that PASS results in more correct diagnoses than either of the other two systems. To date, however, the PASS system has been developed only for alfalfa, corn, and soybean.

Summary

Plant analysis is a powerful tool for confirming nutrient deficiencies, toxicities and imbalances, identifying “hidden hunger,” evaluating fertilizer programs, studying nutrient interactions, and determining the availability of elements for which reliable soil tests have not been developed. The results can be misleading, however, if initial plant sampling, handling, and analysis of the sample are faulty. Experience with interpreting the overall plant analysis report is essential because of the many interacting factors that influence the concentration of any one element in plant tissue. After assessing the status of each nutrient by both interpretative methods, one needs to review possible causes of the effects observed. Thus, cropping history, sampling techniques, soil test data, environmental influences, and a knowledge of nutrient concentrations all need to be considered in the final diagnosis. If properly done, plant analysis can point the way toward more efficient nutrient management and crop production programs.

PLANT ANALYSIS INFORMATION SHEET

**Department of Soil Science
College of Agricultural and Life Sciences
University of Wisconsin-Madison/Extension**

**UW Soil & Plant Analysis Laboratory
5711 Mineral Point Road
Madison, WI 53705 (608) 262-4364**

Date Rec'd (Lab Use Only)		NAME AND ADDRESS			METHOD OF PAYMENT		
Lab No.		Name			Amount paid or Acct. ID		
		Address			Cash or Check No. PO#		
		City State Zip			Credit Card		
		County Code _____ County sample(s) came from:			Credit Card No. _____ - _____ - _____ Exp ____/____		
Sample No.	Field ID	Stage of growth Interpretations only for those listed. (Choose number on back)	Plant part sampled (Choose letter on back)	Crop	Plant appearance (Circle one)	Soil submitted for routine test (pH, OM, P and K) (Circle one)	
					Normal Abnormal	Yes No	
					Normal Abnormal	Yes No	
					Normal Abnormal	Yes No	
					Normal Abnormal	Yes No	
					Normal Abnormal	Yes No	
					Normal Abnormal	Yes No	
					Normal Abnormal	Yes No	
					Normal Abnormal	Yes No	
					Normal Abnormal	Yes No	
					Normal Abnormal	Yes No	
					Normal Abnormal	Yes No	

In addition to routine test (pH, organic matter, phosphorus, and potassium), check soil special test(s) if requested: There is an added charge per test. Report will list fields individually unless designated otherwise:

<p><u>Check special test(s) desired:</u></p> <p>Calcium/Magnesium (Ca/Mg) _____</p> <p style="padding-left: 40px;">Boron (B) _____</p> <p style="padding-left: 20px;">Manganese (Mn) _____</p> <p style="padding-left: 20px;">Sulfur (SO₄-S) _____</p> <p style="padding-left: 20px;">Zinc (Zn) _____</p>	<p style="text-align: center;"><u>List fields</u></p> <p>_____</p> <p>_____</p> <p>_____</p> <p>_____</p>
--	---

DRIS indices available for: alfalfa, apple, corn, celery, lettuce, millet, oat, potato, grain sorghum, tomato and wheat

- PASS indices available for: alfalfa, corn and soybean
- Best information for non-diagnostic stage of growth/plant part can be obtained by comparing good and bad appearing plants from the same field.

If you would like to have results emailed please provide email address below:
Email to: _____

Comments, special instructions, billing information (if different from above):

<u>Field Crops</u>	<u>Stage of Growth</u>	<u>Plant Part Sampled</u>	<u>Number of Plants</u>
Alfalfa, red clover, birdsfoot trefoil, crown vetch	1 Bud to first flower	A Top 6"	30-40
Alfalfa hay, red clover hay	2 Harvest	B Whole plant	15-20
Corn, field	3 12" tall	C Whole plant	10-15
	4 Pre-tassel	D Leaf below whorl	15-20
	5 Tassel to silk	E Ear leaf	15-20
	6 Ensiled/chopped	F Whole plant	10-15
Corn, sweet	7 Tassel to silk	G Ear leaf	15-20
Beans, soybeans, dry lima, snapbeans, peas (canning, chick peas)	8 Prior to or at initial flowering	H 4 th petiole and leaflet or 4 th petiole only	20-25
Potato	9 Prior to or at initial flowering	I 4 th petiole and leaflet or 4 th petiole only	40-50
	10 Tuber bulking	J 4 th petiole and leaflet or 4 th petiole only	40-50
Wheat	11 Tillering	K Newest fully developed leaf	30-40
Wheat, barley, rye, canary grass, triticale, brome grass, oat, orchard grass	12 Prior to heading	L Newest fully developed leaf	30-40
Sorghum, grain	13 Prior to heading	M 2 nd fully developed leaf	15-20
Sorghum-sudan	14 Prior to heading	N Newest fully developed leaf	15-20
<u>Fruits</u>	<u>Stage of growth</u>	<u>Plant part sampled</u>	<u>Number of Plants</u>
Apple, cherry (sour)	15 Current season's shoots	O Fully developed leaf at midpoint of new shoots	10-20
Strawberry	16 At renovation before mowing	P Fully developed leaflets and petioles	10-20
Raspberry	17 August 10 to September 4	Q 6 th and 12 th leaf blade and petiole from trifoliate	10-20
Cranberry	18 August 15 to September 15	R Current season's growth above berries	35-50
<u>Vegetables</u>	<u>Stage of growth</u>	<u>Plant part sampled</u>	<u>Number of Plants</u>
Onion	19 Midseason	S Tops, no white	10-20
Carrots, celery, ginseng, cauliflower	20 Midseason	T Youngest mature leaves	10-20
Tomato	21 Midseason	U Newest fully developed leaf	10-20
Cabbage, lettuce	22 Midseason	V Wrapper leaf	10-20
Pepper	23 Prior to or at early fruit development	W Petiole and leaflet	10-20

SAMPLING FOR PLANT ANALYSIS

K.A. Kelling, S.M. Combs, and J.B. Peters

Sample collection is critical for plant analysis as plant nutrient composition varies with age, the portion of the plant sampled, and many other factors. Mistakes or carelessness in selecting, collecting, handling, preparing, or shipping plant tissue for analysis can result in unreliable data, which may lead to incorrect interpretations and recommendations. Standards, against which the sample is evaluated, have been selected to represent the plant part and time of sampling that best define the relationship between nutrient composition and plant growth. Deviation from the prescribed protocol severely limits this interpretation capability. It is, therefore, critical to follow a standard sampling procedure.

When and How to Sample Plants

Table 1 and Figure 1 outline the proper stage of growth, plant part, and number of plants to sample for major agronomic and horticultural crops. Similar information is depicted in figures on the last page of this publication. If a crop is sampled at other times in the growing season, the analysis will be provided but may not be interpreted on the University of Wisconsin plant analysis report. However, when plant analysis is being used to confirm a suspected nutrient deficiency, the samples should be taken as early in the season as possible so that the deficiency can be corrected and minimize the potential yield loss. Plants showing abnormalities usually continue to accumulate nutrients even if growth is impaired by some limiting factor.

Samples should not be taken from plants that obviously have been stressed from causes other than nutrients. Do not take samples from plants that —

- Are dead or insect damaged;
- Are mechanically or chemically injured;
- Have been stressed by too much or too little moisture (i.e., flooding or drought);
- Have been stressed by abnormally high or abnormally low temperature.

Sample Normal and Abnormal Areas

When a nutrient deficiency is suspected (even without visual symptoms), or there is a need to compare different areas in a field, it is recommended that similar plant parts be collected separately from both the affected plants and adjacent normal plants that are at the same stage of

growth. In this way, a better evaluation can be made between the nutritional status of healthy and abnormal plants of the same variety grown under the same conditions.

Plant Tissue Sample Preparation

After a plant sample has been collected, it should be prepared for shipment or delivery to the laboratory. Roots or foreign material attached to the sample should be removed and discarded. Plant tissue must then be dusted off to remove soil particles. DO NOT WASH tissue since soluble nutrients will be leached out of the sample.

If tissue is to be mailed, the sample should be air-dried above a heating vent or in the sun for one to two days to avoid mold formation during shipment. Place the plant sample in a paper bag in a large paper envelope for shipment. Do not pack

Table 1. Recommended sampling stage of growth, plant part, and sample size for diagnostic plant tissue analysis.

Crop	Stage of growth	Plant part to sample	# of plants to sample
Field Crops			
alfalfa	bud to first flower	top 6 inches	35
alfalfa, hay	harvest	whole plant	25
barley	prior to heading	newest fully developed leaf	50
bean, dry	prior to or at initial flower	newest fully developed leaf	25
bean, lima	prior to or at initial flower	newest fully developed leaf	25
bean, snap	prior to or at initial flower	newest fully developed leaf	25
bluegrass	prior to heading	newest fully developed leaf	50
bromegrass	prior to heading	newest fully developed leaf	50
buckwheat	boot stage	whole plant	20
canary grass	prior to heading	newest fully developed leaf	50
canola	flowering	mature upper leaves	25
corn, field	12 inches tall	whole plant	20
corn	pre-tassel	leaf below whorl	15
corn	tassel to silk	ear leaf	15
corn, silage	ensiled or chopped	whole plant	2 qt
corn, sweet	tassel to silk	ear leaf	15
corn, pop	tassel to silk	ear leaf	15
fescue, fine	new summer growth	clippings	50
lupine	early flower	whole plant	25
millet	4 weeks after clipping	whole plant	25
mint	flowering	whole plant	25
oat	prior to heading	whole plant	50
orchard grass	prior to heading	newest fully developed leaf	50
pea, canning	prior to or at initial flower	newest fully developed leaf	25
pea, chick, field	prior to or at initial flower	newest fully developed leaf	25
potato	prior to or at initial flower	4th petiole & leaflet (whole lvs)	40
potato	tuber bulking	4th petiole & leaflet (whole lvs)	40
potato	prior to or at initial flower	4th petiole from top	50
potato	tuber bulking	4th petiole from top	50
red clover	bud to first flower	top 6 inches	35
red cover hay	harvest	whole plant	25
rice, wild	prior to heading	newest fully developed leaf	50
rye	prior to heading	newest fully developed leaf	50
sorghum, grain	prior to heading	2nd fully developed leaf	20
sorghum-sudan	prior to heading	newest fully developed leaf	50
soybean	prior to or at initial flower	newest fully developed leaf	25
sugar beet	prior to or at initial flower	newest fully developed leaf	25
sunflower	florets about to emerge	newest fully developed leaf	20
tobacco	45 to 60 days after planting	newest fully developed leaf	15
tobacco	early flower	newest fully developed leaf	15
tobacco	mature	leaves	15
trefoil, birdsfoot	bud to first flower	top 6 inches	35
triticale	prior to heading	newest fully developed leaf	50
vetch, crown	bud to first flower	top 6 inches	35
wheat	tillering	newest fully developed leaf	50
wheat	prior to heading	newest fully developed leaf	50

Crop	Stage of growth	Plant part to sample	# of plants to sample
Vegetable Crops			
asparagus	mature fern	fern 17 to 35 inches up	20
beet, red	mid-season	youngest mature leaves	20
broccoli	heading	youngest mature leaves	20
brussels sprouts	heading	youngest mature leaves	20
cabbage	mid-season	wrapper leaves	20
carrot	mid-season	youngest mature leaves	20
cauliflower	mid-season	youngest mature leaves	20
celery	mid-season	youngest mature leaves	20
cucumber	prior to or at early fruit development	youngest mature leaves	20
ginseng	mid-season	youngest mature leaves	35
lettuce	mid-season	wrapper leaves	20
melon	prior to or at early fruit development	newest fully developed leaf	25
muskmelon	prior to or at early fruit development	newest fully developed leaf	25
onion	mid-season	tops, no white portion	20
pepper	prior to or at early fruit development	petiole and leaflet	40
pumpkin	prior to or at early fruit development	newest fully developed leaf	25
spinach	mid-season	newest fully developed leaf	25
squash	prior to or at early fruit development	newest fully developed leaf	25
tomato	mid-season	newest fully developed leaf	40
watermelon	prior to or at early fruit development	newest fully developed leaf	25
Fruit Crops			
apple	current season's shoots (1-15 July)	fully developed leaf at mid- point of new shoots	4 lvs
blueberry	new summer growth	fully developed leaves	35
cherry, sour	current season's shoots (1-15 July)	fully developed leaf at mid- point of new shoots	4 lvs
cranberry	15 Aug to 15 Sept	current season growth above berries	200 uprights
grape	full bloom	newest fully developed	5 from each of 10 vines
petiole			
raspberry	10 Aug to 4 Sept	6th and 12th leaf blade and petiole from tip	2-3 lvs from 10 canes
strawberry	at renovation before mowing	fully developed leaflets and petioles	40

the sample tightly into the mailing container or put samples in plastic or polyethylene bags as this will also promote mold development. Plant samples that are delivered to the laboratory do not need to be air-dried if they are delivered within one day after sampling. Samples to be delivered directly to the laboratory at a later date may be kept frozen or air-dried until they are delivered.

Include Soil Sample

Soil test results for pH, organic matter, phosphorus, and potassium (routine test) can be useful for correlating with plant analysis results to pinpoint a nutrient problem. A composite soil sample, consisting of five or more cores, should be taken from the same area where the plant sample was collected. For row crops, avoid the fertilizer band by sampling from the middle of the row. Put the sample into a soil sample bag or other waterproof container and label the soil sample with the same field and sample number as that assigned to the tissue sample. Package corresponding plant and soil samples together, but make certain soil sample bags do not open in transit as spilled soil will contaminate plants. No additional fee is charged for routine soil analysis when submitting along with a plant sample. Special soil test requests for Ca, Mg, S, B, Mn, or Zn are assessed an extra fee. For further details on proper soil sampling procedures, refer to UWEX Publication A21, "Sampling Soils for Testing."

What To Do With Samples

A "Plant Analysis Information Sheet" should be filled out for any samples submitted. Use a separate information sheet for each sample. Plant samples, corresponding soil samples, and accompanying information sheets can be obtained and turned in at your County Extension Office. Samples may also be sent or delivered to the laboratory directly. The University of Wisconsin laboratory that conducts the plant analysis program is the Soil and Plant Analysis Laboratory at Madison. The address and telephone number are:

UW Soil and Plant Analysis Laboratory
5711 Mineral Point Road
Madison, WI 53705
608-262-4364

Some, but not all, private laboratories also analyze plant tissues; therefore, you should check with your laboratory on the specific services they provide before submitting the samples.

What the Analysis Report Will Include

The report will show the concentration of N, P, K, Ca, Mg, S, Zn, Mn, B, Cu, Fe, Al, and Na in the plant sample. If a soil was submitted with the plant sample, soil analyses for pH, organic matter, P, K, and any special soil test results will also be reported. In addition, the analytical levels of nutrients in the plant and soil will be interpreted to reflect nutrient deficiencies, toxicities, or imbalances by the sufficiency range approach, and if calibration data are available, the nutrient ratio method. When warranted, fertilizer recommendations will be made based on the analytical results. Most commonly grown field vegetables and fruit crops will receive these interpretations and recommendations. For those plant materials where calibration data are not available, these analytical results will be provided without interpretation.

Wisconsin's Nutrient Management Standard 590

- Summary -

September 2005 Revision

Criteria for All Sites

1. General Cases

- A. Annual field-specific nutrient application plan consistent with UWEX soil fertility recs. (A2809).
- B. Plan shall be based on realistic yield goals – no higher than 15% above the previous 3-5 year average.
- C. Routine soil testing shall be conducted at least once every four years.
 - 1) Sample soils according to UWEX recs (A2100).
 - 2) Analysis by a WDATCP-certified lab.
- D. Annual phosphorus (P) and potassium (K) recommendations may be combined into a single application to meet the total nutrient needs over the crop rotation.
 - 1) Combined annual application not allowed on frozen or snow-covered ground.
 - 2) Commercial P fertilizer shall not be applied to fields with soil test P in the excessively high (non-responsive) range.
 - Exception of up to 20 lb/a of P₂O₅ starter for corn.
 - 3) Credit all P and K starter fertilizer against crop needs.
- E. Soil pH should be adjusted to optimum ranges.
- F. Nitrogen (N) applications shall not exceed annual crop need (or uptake).
 - 1) Exception: If legumes, manures, and/or organic byproducts are the only sources of N, N rate may exceed crop need by 20%.
 - 2) Credit any starter N fertilizer in excess of 20 lbs/a.
- G. First- and second-year legume-N credits shall be accounted and utilized.
- H. First-year available manure nutrient credits shall be accounted and utilized using either:
 - 1) Laboratory manure-nutrient analysis.
 - 2) UW estimates of first-year available nutrient content of manure.
- I. Other organic byproducts applied to fields need to be analyzed for nutrient content and applied according to existing regulations.
- J. Nutrients shall not run off fields during or immediately after application.
- K. Nutrient applications based on plant tissue analysis shall be done in accordance with UW sampling, testing, and interpretation guidelines.
- L. Where gleaming/pasturing occurs, do not allow the N and P manure additions to exceed the requirements of this standard.

2. Nutrient Application Prohibitions

- A. Nutrients shall not be spread on:
 - 1) Surface water, concentrated flow channels, vegetative buffers, non-farmed wetlands, sinkholes, gravel/sand pits, wells.
 - 2) Non-cropland and/or non-pastured land.
 - Exception: Establishment and maintenance nutrient requirements are allowed.
 - 3) Areas within 50 feet of a well - - applies to manure only.
 - 4) Areas contributing runoff 200 feet upslope of direct conduits to groundwater (wells, sinkholes, surface fractured bedrock, tile inlets, or gravel/sand mines) unless nutrients are incorporated within 3 days.
 - 5) Fields exceeding tolerable soil loss (T).
- B. Frozen or snow-covered soil nutrient application prohibitions:
 - 1) 1,000 feet of a lake, pond, flowage or within 300 feet of a river/perennial stream (SWQMAs),
 - 2) Areas identified as direct conduits to groundwater or surface water,
 - 3) P removal of the following growing season's crop is not to be exceeded when applying manure. Liquid manure applications limited to 7,000 gallons/acre,
 - 4) Slopes greater than 9%.
 - Exception: Up to 12% for manure applications on contoured or contour stripped fields.
 - 5) No commercial N or P fertilizer.
 - Exception: Grass pastures and winter grains not contained in above prohibition areas.

3. Nutrient Application Restrictions

- A. Application rates for unincorporated liquid manure on non-frozen soils within a SWQMA are not to exceed Table 1 values.
 - 1) No applications allowed on saturated soils.
 - 2) Subsequent manure applications possible (as standard allows) after 7 days or after soil evaluation (Table 1).
- B. All nutrient applications on non-frozen soil within a SWQMA shall be in conjunction with one or more of the following practices:
 - 1) Permanent vegetative buffers,
 - 2) Greater than 30% crop residue or vegetative cover after nutrient application,
 - 3) Incorporation within 3 days of application leaving adequate residue to meet "T",
 - 4) Cover crops established promptly following application.

Criteria for Groundwater Protection

Applies to high permeability soils (sands, etc.), soils with less than 20 inches to bedrock, or soils with less than 12 inches to apparent water table. Also fields within 1,000 feet of a municipal well

1. N Application Restrictions:

- A. No fall applications of commercial N.
 - **Exception:** Establishment of fall-seeded crops - 30 lb N/acre maximum.
- B. Apply one of the following practices on irrigated fields, includes irrigated manure:
 - 1) Apply majority of N after crop establishment (sidedress or split), *or*
 - 2) Utilize a nitrification inhibitor with ammonium forms of N.

2. Manure-N Application Restrictions:

- A. When manure is applied in late summer/fall when soil temperatures are greater than 50° F, meet one of the following:
 - 1) Use a nitrification inhibitor with liquid manure and limit rate to 120 lbs N/acre,
 - 2) Apply after Sept. 15 and limit rate to 90 lbs N/acre,
 - 3) Apply to perennial or fall-seeded crops and limit rate to 120 lbs N/acre *or* the crop's N requirement – whichever is less.
- B. When manure is applied in fall and soil temperatures are 50° F or lower, limit rate to 120 lbs N/acre *or* the crop's N requirement – whichever is less.

3. P Leaching Restrictions:

- A. Where P additions to groundwater are identified, implement practices to reduce P delivery.

Criteria for Surface Water Protection

1. Where manure, fertilizers, or organic byproducts are applied:

- A. Avoid building soil test P values beyond the excessively high range for the most demanding crop in the rotation (30 to 50 ppm for most agronomic crops).
- B. Establish perennial vegetative cover in all areas of concentrated flow where gullies occur.

2. Develop a plan for managing P when manure or organic byproducts are applied using one of the following strategies. Selected strategy must be applied uniformly to all fields within a farm or tract.

- A. Phosphorus Index (PI) Strategy:
 - 1) The PI assesses P delivery to surface waters from fields. See <http://wpindex.soils.wisc.edu>,
 - 2) The planned PI value for up to an 8-year rotation of each field shall be 6 or lower.
 - 3) P applications on fields with a PI > 6 are allowed only if needed according to UWEX soil fertility recs.

B. Soil Test P Strategy:

- 1) P applications from all sources must be based on the following soil test P values:
 - a) < 50 ppm P - Nutrient applications allowed up to crop N need/removal,
 - b) 50 – 100 ppm P - Applications of P shall not exceed crop removal of P over a rotation (8 year max),
 - c) > 100 ppm P - Eliminate P applications, unless required by highest P-demanding crop in the rotation.
 - **Exception:** If P (i.e. manure-P) must be applied, applications shall be 25% less than the cumulative annual crop P removal over the rotation (8 year max).
 - **Exception:** For potatoes, P applications shall not exceed rotational crop removal (8 year max) if soil tests are optimum, high, or excessively high for potatoes.

Criteria for Air Quality Protection

Where air quality is identified as a concern, a management plan that minimizes N volatilization and particulate emissions while maintaining "T" shall be applied.

Criteria for Soil Quality Protection

1. Nutrients shall be applied in a manner that does not permanently degrade the soil's physical, chemical, or biological conditions.
2. To the extent practical, nutrients shall not be applied to flooded or saturated soils when the potential for soil compaction is high.

Table 1. Maximum unincorporated liquid manure application rate within a SWQMA.

Soil Texture Class ¹	Maximum Application Rate		Allowable Soil Moisture Description for Applications
	< 30% ²	> 30% ²	
	----- gal/acre -----		
Fine	3,000	5,000	Easily ribbons out between fingers, slick feel.
Medium	5,000	7,500	Forms a ball, very pliable, slicks readily with clay.
Coarse	7,000	10,000	Forms a weak ball, breaks easily.

¹ Fine – clay, silty clay, silty clay loam, clay loam; Medium – sandy clay, sandy clay loam, loam, silt loam, silt; Coarse – loamy sand, sandy loam, sand. The coarse category also includes peat and muck.

² Crop residue or vegetative cover on the soil surface after manure application.

Nutrient Management Standard 590: Criteria Summary - ver. 3/99

I. Minimum Requirements

A. General cases

1. Soils tested at least every four years
2. Field by field nutrient budget - consistent with UWEX recommendations
 - * Starter N in excess of 20 lb N/a is credited
 - * Credit nutrients according to UWEX recommendations
3. N applications not to exceed crop need (*Exception: If the only source of N is legumes, manures, etc., N rate may exceed crop need by 20%*)
4. No commercial fertilizer applications on frozen or snow covered ground
(*Exceptions: Grass pastures of 6% or less slope north of Hwy. 29, Winter grains, statewide*)

B. Manure & organic byproducts applied to crops

1. Organic byproducts other than manure or septage shall be analyzed for nutrient content
2. Follow existing regulations
3. Surface applied manures and organic byproducts shall not run off the intended site during application

C. Manure & organic byproduct applications to non-cropland

1. Liquid must be injected across slopes of 3% or greater
2. Application rates not to exceed 75 lb P₂O₅/acre total for 5 years unless incorporated
3. Apply after July 15 and before freeze-up

II. Additional Criteria for Groundwater Protection

A. On sands & loamy sands, fall liquid manure shall contain a nitrification inhibitor if applied when soil temperatures are above 50°

B. No fall applications of commercial N on sands & loamy sands

C. Manure & organic byproducts shall not be applied to the following areas unless injected or incorporated within 72 hours:

1. 200 ft upgradient of sinkholes, cracked bedrock, wells
2. Locally identified areas having a high potential to pollute groundwater

D. Commercial N rates not to exceed UWEX recommendations

(continued on next page)

III. Additional Criteria for Surface Water Protection

- A. Manure shall not be applied at rates exceeding 75 lb P₂O₅/acre/year unless incorporated within 72 hours. If incorporated, N becomes the restricting nutrient**
- B. Soil loss tolerance (T) not to be exceeded on fields receiving manure and organic byproducts**
- C. Manure & organic byproducts shall not be spread in waterways, wetlands, terrace channels, etc.**
- D. Manure & organic byproducts shall not be applied to the following areas unless injected or incorporated within 72 hours:**
 - 1. 10-year floodplain or within 200 feet of streams, rivers, or lakes, whichever is greater
 - 2. 200 feet upgradient of sinkholes, cracked bedrock, wells
- E. Manure & organic byproducts shall not be applied on frozen or snow covered ground in the following areas:**
 - 1. III (D) - above
 - 2. Slopes greater than 9% (Exception: Up to 12% is allowed if contour stripped with sod, or contour farmed with all corn residue remaining)
 - 3. Locally identified areas with a high potential to pollute surface water
- F. Manure & organic byproducts can be applied on frozen or snow covered ground on locally identified areas having a low potential to pollute surface water**
- G. Commercial P applications not to exceed UWEX recommendations**

Natural Resources Conservation Service

Nutrient Management:

Standard-590 - ver. 3/99

Definition

Managing the amount, form, placement, and timing of applications of plant nutrients.

Scope

This standard establishes the minimum acceptable requirements for the application of plant nutrients associated with organic wastes (manure and organic byproducts), commercial fertilizer, legume crops, and crop residues.

Purposes

This practice may be applied as part of a conservation management system to support one or more of the following purposes:

- Supply plant nutrients for crop production.
- Minimize entry of nutrients to surface water.
- Minimize entry of nutrients to groundwater.

Conditions Where Practice Applies

On lands where plant nutrients are applied.

Criteria

Because this is the first conservation practice standard designed to use the new SCS planning procedure, a short explanation of the application of criteria based on identified purpose is provided.

In order to address the purpose of supplying nutrients for crop production, criteria I must be applied.

It would be extremely rare in Wisconsin to find a field with an identified concern of nutrients applied for production where there would not also be a concern for the entry of nutrients to either surface or groundwater. Criteria I would only be used alone where Total Resource Planning did not identify a surface or groundwater concern. Food Security Act and Farmland Preservation Plans are not Total Resource Plans.

In order to address the purpose of minimizing the entry of nutrients to surface water, criteria I and II must be applied.

The criteria for minimizing the entry of nutrients to surface water will be applied to the majority of the fields in Wisconsin.

In order to address the purpose of minimizing entry of nutrients into groundwater, criteria I and II must be applied.

The criteria for minimizing the entry of nutrients to groundwater will be applied in areas with groundwater concerns, ie, Lower Wisconsin River Valley, Central Sands, Atrazine Prohibition Areas, etc.

This practice would be used to treat these identified resource concerns:

Soil	Soil Contaminants: Excess Animal wastes and other organics Excess Fertilizer
Water	Quality: Nutrients and Organics in Groundwater Nutrients and Organics in Surface Water
Plant	Management: Nutrient Management

I. Minimum Criteria To Provide Nutrients For Crop Production And To Minimize Entry Of Nutrients To Surface Water And Groundwater.

A. General Cases:

1. Soils shall be tested a minimum of once every four years.
2. Develop field by field nutrient budget for all major nutrients consistent with UWEX Publication "A-2809". Conservation Planning Tech Note WI-1 spells out the minimum requirements for a Nutrient Management Plan.
3. Available nitrogen, including nitrogen from legumes, manure, sludge, organic byproducts, and commercial sources, shall not exceed nonlegume crop needs, except that, available nitrogen may exceed crop needs by up to 20% if legumes, manures and organic byproducts are the only sources of nitrogen.
4. Commercial fertilizer shall not be applied to frozen or snow covered ground except for grass pastures on slopes of six percent or less north of Wisconsin Highway 29 and winter grains throughout the state.

B. Manure and organic byproducts applied to crops for harvest

1. Organic byproducts other than manure or seepage shall be analyzed for nutrients. Other analyses may be required as prescribed by state, federal, or local regula-

tions. These materials shall be spread as prescribed by federal, state, or local regulations (see Wis. Department of Natural Resources Code, NR214 (industrial wastes), NR204 (municipal sludges), NR113 (septage)). Required documentation shall be maintained by the applicator. These materials may require injection or incorporation within specified time periods.

2. Surface spread liquid manures and organic byproducts shall not run off the intended site during application. Application must be stopped if ponding or runoff begins.

C. Manure and organic byproducts applied on land where vegetation is not harvested. This does not include non-farmed wetlands.

1. Liquid materials shall be injected across slopes that are 3% or greater or be surface spread.

2. Application rates shall not exceed 75 lb available P_2O_5 /acre (32.8 lb P/acre) total for a 5-year period unless incorporated.

3. Application of manure shall occur between July 15 and freeze-up to minimize damage to wildlife habitat.

II. Additional Criteria To Minimize Entry Of Nutrients To Groundwater

A. Manure shall contain a nitrification inhibitor if it is injected in the fall on sands, and loamy sands when the soil temperature is above 50 degrees F.

B. Commercial nitrogen fertilizer for spring seeded crops shall not be fall applied on sands and loamy sands.

C. Manure and organic byproducts shall not be applied to the following areas unless injected or incorporated with 72 hours:

1. Within 200 feet up gradient of sinkholes, creviced bedrock at the surface, or other direct conduits to the groundwater, such as gravel pits and wells.

2. Other locally identified areas documented as having a high potential to pollute groundwater resources.

D. Commercial nitrogen application rates shall not exceed recommendations based on crop need.

75 lb available P_2O_5 /acre/year (32 lb P/acre) unless these materials are incorporated within 72 hours after application, in which case, the nitrogen content of the manure becomes the restricting nutrient. Applications of manure cannot be at a level which delivers more nitrogen than the crop needs. The nutrient content of manure shall be determined through a laboratory analysis or from SCS Conservation Planning Technical Note 1.

B. The soil loss tolerance will not be exceeded on soils receiving manure and organic byproducts.

C. Manure and organic byproducts shall not be spread in established waterways, non-farmed wetlands, terrace channels or other areas where runoff concentration occurs.

D. Manure and organic byproducts shall not be applied to the following areas unless injected or incorporated within 72 hours:

1. Within the 10-year floodplain or within 200 feet of streams, rivers, or lakes, whichever is greater,

2. Within 200 feet up gradient of sinkholes, creviced bedrock at the surface, or other direct conduits to the groundwater, such as gravel pits and wells.

E. Manure and organic byproducts shall not be applied on frozen or snow-covered ground in the following areas:

1. Areas identified in III (D) (above),

2. Slopes of greater than 9%, except for manure on slopes up to 12% with well grassed waterways, that are either contour strip cropped with alternate strips in sod, or contour farmed with all the residue from a corn crop taken for grain remaining on the surface.

3. Other locally identified areas documented as having a high potential to pollute surface water resources.

F. Manure and organic byproducts may be applied on frozen or snow covered ground on locally identified areas documented as having a low potential to pollute surface water.

G. Commercial phosphorus application rates shall not exceed recommendations based on crop need.

H. Additional guidance for reducing entry of nutrients into surface water may be found in

III. Additional Criteria To Minimize Entry Of Nutrients To Surface Water

A. Manure shall not be applied at rates exceeding

Conservation Planning Technical Note 1.

Planning Considerations

1. Manure should not be winter spread on sites that are likely to deliver nutrient runoff to surface waters and/or groundwater. *(See Conservation Planning Technical Note 1 for guidelines concerning areas with high pollution hazard for surface runoff.)*
2. Manure should be stored in properly located and constructed facilities during periods when land application is not suitable. *(See UWEX Publication A-3466 for more information)*
3. Manure applications to no-till cropping systems should be injected to avoid nutrient runoff and maximize nutrient availability. Surface applications should be avoided.
4. Vegetative filter strips, along with other erosion control practices, should be maintained adjacent to surface water, wetlands, sinkholes, and rock outcrops in order to reduce the amount of sediment and nutrients which actually reach surface water and/or groundwater.
5. Evaluate federal, state, and local water quality standards and designated use limitations, such as city, county, and township zoning ordinances.

Plans And Specifications

Plans and specifications will be prepared for a specific site based on this standard, and planning instructions provided in Conservation Planning Technical Note 1.

1. Nutrients shall be applied consistent with federal, state, and local regulations.
2. Industrial wastes and byproducts are regulated under NR214, Wisconsin Administrative Code. They must be spread in accordance with a Wisconsin pollution Discharge Elimination System (WPDES) Permit as obtained from the Wisconsin Department of Natural Resources (WDNR).

Operation, Safety And Maintenance

1. Minimize operator exposure to potentially toxic gases associated with manure, organic wastes and chemical fertilizers, particularly in enclosed areas. Wear protective clothing appropriate to the material being handled.
2. Protect commercial fertilizer from weather, and agricultural waste storage facilities from accidental leakage or spillage.

See Chapter Ag 162 of Wisconsin Administrative rules and County Waste Storage Facilities Ordinances concerning regulations on siting, design, operation and maintenance of these facilities.

3. When cleaning equipment after nutrient application, remove and save fertilizers or wastes in an appropriate manner. If system is flushed, use rinse water in the following batch of nutrient mixture, where possible, or dispose of according to state and local regulations. Always avoid cleaning equipment near high runoff areas, ponds, lakes, streams, and other water bodies. Extreme care must be exercised to avoid contaminating wells.
4. Application equipment must be calibrated to achieve the desired application rate.

Working Tools

1. SCS Conservation Planning Technical Note 1
2. University of Wisconsin-Extension (UWEX) Publication "A2809, Soil Test Recommendations for Field, Vegetable, and Fruit Crops", Rev. 1991.
3. University of Wisconsin-Extension (UWEX) Publication "A3512, Wisconsin's Preplant Soil Profile Nitrate Test".
4. University of Wisconsin-Extension (UWEX) - Wisconsin Department of Agriculture, Trade, and Consumer Protection (UWEX-DATCP) Publication "A-3466, Nutrient and Pesticide Best Management Practices for Wisconsin Farms", June 1989.
5. University of Wisconsin-Extension (UWEX) Publication "A2100, Sampling Soils for Testing".
6. University of Wisconsin-Extension (UWEX) Publication "A3517, Using Legumes as a Nitrogen Source", May 1991.
7. University of Wisconsin-Extension (UWEX) Publication "A3537, Nitrogen Credits for Manure Applications", May 1991.
8. University of Wisconsin-Extension (UWEX) Publication "A3557, Nutrient Management: Practices for Wisconsin Corn Production", May 1992.
9. University of Wisconsin-Extension (UWEX) Publication "A3568, A Step-by-Step Guide to Nutrient Management", May 1992.
10. University of Wisconsin-Extension (UWEX) Publication "A3600, Wisconsin's Irrigation Scheduling Program".
11. Wisconsin Department of Natural Resources Codes NR214, (Land Treatment of Industrial Liquid Wastes, By-product Solids and Sludges); NR204 (Municipal Sludge Management) and NR113 (Septage).
12. WISPer Model, The Wisconsin Interpretive Soil Test Program Ver. 2.0 for Economic Recommendations, University of Wisconsin-Extension.

A Step-by-Step Guide to Nutrient Management

Richard P. Wolkowski



Introduction

This publication is designed to help farmers, consultants, governmental agencies, fertilizer dealers, and others determine the crop nutrient requirements of individual fields. The assessment will focus on the primary nutrients – nitrogen (N), phosphorus (P), and potassium (K) – because they represent the largest cost to the farmer and present the greatest risk to the environment when improperly managed. A logical, step-wise process is used to calculate the amount of nutrients needed to grow a crop by accounting for nutrients that are available from several sources.

The assessment begins with the fertilizer recommendations found on the soil test report. The soil test recommendations are based on the level of available nutrients in the soil and the nutrient demand of the crop(s) to be grown. Nutrient credits for soil organic matter, manure, legumes, and/or residual soil nitrate need to be subtracted from the fertilizer recommendation to determine the adjusted nutrient need. Worksheets for conducting field-specific nutrient assessments can be found near the end of this publication. Once completed, this worksheet can be filed with the

soil test report to furnish a record of fertilization and cropping information. Recommendations and credits used in this publication are identical to those used by the University of Wisconsin Soil Testing Program and can also be developed by using the Wisconsin Interactive Soil Program for Economic Fertilizer Recommendations (WISPer) computer program.

Where the University of Wisconsin soil test recommendation program is used, and accurate manure and legume crediting information is provided with the soil samples, nutrient credits are subtracted from the total nutrient requirement. In this case, the adjusted nutrient need has been calculated and the farmer can determine a fertilization program. Where other soil testing programs are used or when a change in management plans occur, the adjusted nutrient need may have to be calculated by the individual grower, farm manager, or crop consultant.

Ideally, nutrients should be applied to fields at rates matching the adjusted nutrient need. However, for reasons of practicality it is expected that fields with similar nutrient recommendations will be grouped together. Then a whole-farm fertilization program can

be developed using the adjusted field nutrient needs from the worksheet to determine a reasonable number of rates and blends of fertilizer materials. An additional worksheet, found at the end of this publication, tallies the adjusted nutrient requirements from individual fields. This can serve as a nutrient management plan for the entire farm.

Completing the Worksheet

Step 1. Field Information

Fill in the appropriate information for field identification, year, size, crop, soil name(s), and previous crop. This will provide a condensed record containing the treatment of each field and can serve as a future reference. Enter this information on the worksheet in the space provided in box 1.

Step 2. Nutrient Need

Determine field-specific nutrient needs by completing the worksheet according to the following directions.

Recommended N-P₂O₅-K₂O. From the soil test report form fill in the recommendations for N, phosphate (P₂O₅), and potash (K₂O) in the spaces at line 2a. These are the nutrients which the soil test levels, crop to be grown, and yield goal indicate are needed for each acre in the selected field. University of Wisconsin soil test reports provide nutrient recommendations for two different crop rotation options. It is important to note that nutrient recommendations from soil test reports may not account for nutrient credits when services other than University of Wisconsin or ASCS- approved soil testing laboratories are used.

Special N-P₂O₅-K₂O. Certain cropping conditions can affect crop nutrient needs. Special nutrient recommendations are printed as a comment on University of Wisconsin soil test reports. These recommendations are not considered in the cal-

Table 1. Recommended special fertilization adjustments for special cropping situations.

Situation	Recommendation
Conservation tillage	Where more than 50% residue cover remains on the surface, increase the N requirement for corn by 30 lb/a N.
Corn silage	Where corn is harvested for silage and soil tests are in the optimum range or below, apply 30 lb P ₂ O ₅ and 90 lb K ₂ O per acre to the succeeding crop. (If soil test P or K exceed the optimal level do not apply the additional nutrients).
Legume forage	Where an alfalfa stand is to be maintained for more than three years increase the annual topdressed potash application by 20%. Apply 30 lb/a N in the seeding year if grown on soils with less than 2% organic matter. Apply 40 lb/a N for legume pasture on sandy soils and 20 lb/a N for legume pasture on soils with less than 2 % organic matter.
High P soils	If soil test P levels exceed 150 ppm, do not apply additional P, except for a maximum of 20 lb/a of starter P ₂ O ₅ for row crops.
N availability tests	Where a N availability test, such as the preplant soil or the pre-sidedress nitrate test has been performed, use the recommended N adjustment.
Nurse crops	Where barley or oats are seeded with a legume forage, reduce N by 50%.
Sandy soils	Recommended N should be applied in sidedress or post emergence split applications.
Sewage sludge	Where sewage sludge is to be applied the soil pH must be 6.5 or higher.

ulation of the report's fertilizer recommendation. It is the responsibility of the user to include the special nutrient recommendations in the final calculation of nutrient application rates. A summary of the most common of these recommendations is listed in Table 1. Enter any special N, P₂O₅, K₂O recommended at line 2b.

The nutrient need for the primary nutrients can be determined by adding lines 2a and 2b. Fill in the sum for each nutrient at line 2c.

Starter fertilizer. It is commonly recommended that a minimal amount of starter fertilizer be applied for corn planted in soils slow to warm in the spring. For corn grown on medium and fine textured soils, apply at least 10 lb N, 20 lb P₂O₅, and 20 lb K₂O per acre at planting as a starter fertilizer. In most row crop fields, all the recommended P₂O₅ and K₂O can be applied as starter fertilizer. On soils with test levels in the excessively high range, starter fertilizer applications in excess of 10 lb/a N, 20 lb/a P₂O₅, and 20 lb/a K₂O should be avoided. The amount of N applied as starter fertilizer that exceeds 20 lb/a should be credited against the overall N recommendation.

In-row placement of fertilizer is an efficient means for supplying crop nutrients. The fertilizer is placed near the germinating seed and is immediately available to the crop. Starter fertilizer application is an ideal method of applying a relatively small amount of nutrients to row crops. Starter applications usually supply all the recommended P₂O₅ and K₂O for soils testing in the optimum or higher ranges.

Secondary and micronutrients. If soil tests for other nutrients (eg., Ca, Mg, S, Zn, B, Mn) were performed, refer to the comments section of the soil test report form to determine if any of the tests indicate a need for secondary or micronutrients. Applications of these nutrients may also be considered without a soil test when there is evidence of a need through plant analysis, visual deficiency symptoms, or previous experience. Enter the recommended application of the appropriate nutrient at line 5a.

Table 2. Availability estimates for N, P₂O₅, and K₂O for un-analyzed solid manure.

Animal Type	Available		
	N	P ₂ O ₅	K ₂ O
	lb per ton		
First Year			
Dairy	3(4) ¹	3	8
Beef	4(4)	5	8
Poultry	13(15)	14	9
Swine	4(5)	3	7
Second Year			
Dairy	4(5)	3	9
Beef	5(6)	6	9
Poultry	15(18)	16	10
Swine	5(6)	4	8
Third or more			
Dairy	5(5)	4	9
Beef	6(6)	6	10
Poultry	16(19)	18	11
Swine	6(7)	4	8

¹ Nutrient values in parenthesis are for incorporated manure

Lime needs. The need for lime must not be overlooked, because a low soil pH will reduce the response to applied nutrients. Where a lime recommendation is given on the soil test report, enter the recommended rate of 60-69 or 80-89 neutralizing index (NI) lime at line 5b. If the lime to be used has a different NI calculate the amount needed using the equation provided below.

$$\text{Lime to apply} = (\text{t/a } 60\text{--}69 \text{ required}) \times \frac{65}{\text{Midpoint NI of your lime}}$$

Step 3. Nutrient Replacement Credit

A goal of nutrient management planning is to allow farmers the opportunity to maximize the value of their on-farm nutrients. For most Wisconsin farms this means utilizing fertilizer replacement credits for legumes, manure, or carry-over soil nitrogen.

Manure. Manures contain significant amounts of the primary plant nutrients (N, P, and K), as well as other essential plant nutrients. An accurate manure nutrient credit can be determined only if the *available nutrient content of the manure* and the *manure application rate* are known.

Table 3. Availability estimates for N, P₂O₅, and K₂O for the application of un-analyzed liquid manure.

Animal Type	Available		
	N	P ₂ O ₅	K ₂ O
	lb per 1000 gal		
First Year			
Dairy	8(10) ¹	8	21
Beef	10(12)	14	23
Poultry	35(41)	38	25
Swine (f.u.) ²	22(28)	15	26
Swine (f.n.)	12(15)	6	8
Second Year			
Dairy	11(13)	9	24
Beef	14(16)	16	26
Poultry	42(48)	45	28
Swine (f.u.)	28(33)	18	29
Swine (f.n.)	15(18)	7	9
Third or more			
Dairy	13(14)	10	25
Beef	16(18)	17	28
Poultry	45(52)	48	30
Swine (f.u.)	30(36)	19	31
Swine (f.n.)	17(20)	8	9

¹ Nutrient values in parenthesis are for incorporated manure.

² f.u. = finishing unit; f.n. = farrow nursery

Table 4. First year availability estimates for N, P₂O₅, and K₂O for analyzed manure.

Animal Type	First year availability		
	N	P ₂ O ₅	K ₂ O
	Percent available nutrients		
Dairy	30(35) ¹	55	75
Beef	25(30)	55	75
Poultry	50(60)	55	75
Swine	40(50)	55	75

¹ Nutrient values in parenthesis are for incorporated manure.

For analyzed manure, multiply the total nutrient content by the appropriate percent available nutrients found in Table 5 and the application rate. If manure has been applied to the same field at similar rates for two or three consecutive years, increase the nutrient availability of each nutrient by 10% or 15%, respectively.

Source: USDA-SCS *Wisconsin Field Office Tech. Guide*, Sec. IV-Spec. 590.

Examples for calculating manure nutrient credit:

1) Not analyzed, first year of application.

$$\frac{\text{Manure applied in tons or gallons}}{\text{acre}} \times \frac{\text{lb Nutrient}}{\text{tons or 1000 gal}} = \frac{\text{lb Nutrient credit}}{\text{acre}}$$

a) 30 T/a Solid dairy manure, incorporated.

$$\frac{30 \text{ tons}}{\text{acre}} \times \frac{4 - 3 - 8 \text{ lb (N - P}_2\text{O}_5 - \text{K}_2\text{O)}}{\text{ton}} = \frac{120 - 90 - 240 \text{ lb (N - P}_2\text{O}_5 - \text{K}_2\text{O)}}{\text{acre}}$$

b) 10,000 gal/a liquid dairy manure, not incorporated.

$$\frac{10,000 \text{ gal}}{\text{acre}} \times \frac{8 - 8 - 21 \text{ lb (N - P}_2\text{O}_5 - \text{K}_2\text{O)}}{1000 \text{ gal}} = \frac{80 - 80 - 210 \text{ lb (N - P}_2\text{O}_5 - \text{K}_2\text{O)}}{\text{acre}}$$

2) Analyzed, first year of application.

$$\text{Manure application rate} \times \text{Total nutrient content} \times \text{Available nutrient fraction} = \text{Nutrient credit}$$

a) 30 T/a solid dairy manure, incorporated.

$$\frac{30 \text{ tons}}{\text{acre}} \times \frac{10 - 6 - 11 \text{ lb (N - P}_2\text{O}_5 - \text{K}_2\text{O)}}{\text{ton}} \times 0.35 - 0.55 - 0.75 \text{ (N - P}_2\text{O}_5 - \text{K}_2\text{O)} = \frac{105 - 99 - 248 \text{ lb (N - P}_2\text{O}_5 - \text{K}_2\text{O)}}{\text{acre}}$$

Manures vary in nutrient content depending upon the animal type and livestock management system. Nutrients contained in manures are not immediately available to crops but are gradually released over time. Therefore, the amount of nutrients which should be credited from manure increases if applications are made to the same field for consecutive years. The N credit increases each successive year of application (up to three consecutive years) by approximately 30%. For example, N credits with consecutive applications of surface-applied dairy manure are 3, 4, and 5 lb/ton N in the first, second, and third or more years of application, respectively (Table 2). Credits for P and K increase somewhat less.

There are several methods that can be used to determine the manure application rate.

These include:

- 1) weighing a full spreader or estimating weight according to spreader volume and calculating the number of loads needed to cover a known acreage;
- 2) calculating the spreader output by driving at a constant speed over a plastic sheet of known size and weighing the manure collected on the sheet; or
- 3) calculating the manure output of confined animals based on their size and type.

Consult UWEX publication A3537, *Nitrogen Credits for Manure Applications*, for more information on estimating manure application rates.

Table 5. Nitrogen credit for legumes.

Legume crop	N Credit	Special Considerations
<i>Forages</i>		
FIRST YEAR CREDIT		
Alfalfa	190 lb N/acre for a good stand ¹ 160 lb N/acre for a fair stand ¹ 130 lb N/acre for a poor stand ¹	Reduce credit by 50 lb N/acre on sandy soils. ² Reduce credit by 40 lb N/acre if less than 8 inches of regrowth after last harvest.
Red clover Birdsfoot trefoil	Use 80% of alfalfa credit	Same as alfalfa.
SECOND YEAR CREDIT		
Fair or good stand	50 lb N/acre	No credit on sandy soils. ²
<i>Soybeans</i>	40 lb N/acre	No credit on sandy soils. ²
<i>Leguminous vegetables</i>		
Peas Snapbeans Lima beans	20 lb N/a	No credit on sandy soils. ²
<i>Green Manure</i>		
Alfalfa Red Clover Sweet Clover	60-100 lb N/acre 50-80 lb N/acre 80-120 lb N/acre	Use 20 lb N/acre credit if field has less than 6 inches of growth before tillage, killing frost, or herbicide application.

¹A good stand of alfalfa (70-100% alfalfa) has more than 4 plants/ft²; a fair stand (30-70% alfalfa) has 1.5 to 4 plants/ft²; and a poor stand (<30% alfalfa) has less than 1.5 plant/ft².

²Sandy soils are sands and loamy sands.

Example for calculating legume nitrogen credit:

Alfalfa (fair stand, sandy soil, fall harvest)

Base Credit	Sandy Soil Deduction	Fall Harvest Deduction	Actual Credit
<u>160 lb N</u>	<u>- 50 lb N</u>	<u>- 40 lb N</u>	<u>= 70 lb N</u>
acre	acre	acre	acre

Nutrient losses from manure can be minimized by incorporating surface applied manure within 72 hours. If manure remains on the soil surface, losses of nutrients may occur to the atmosphere or in runoff.

To determine nutrient credits for manure that has not been analyzed, establish the field manure history and use the values in Tables 2 or 3. Multiply the manure application rate by the appropriate nutrient content (lb per ton or lb per 1000 gal). In situations where the nutrient content of manure has been analyzed, multiply the total nutrient content by the appropriate percent available nutrient value (found in Table 4) by the application rate. If analyzed manure has been applied to the same field at similar rates for two consecutive years, increase the nutrient availability of each nutrient by 10%. If manure has been applied to the same field at similar rates for three or more consecutive years, increase the nutrient availability in Table 4 by 15%. Enter the manure credit on line 3a.

The University of Wisconsin soil test recommendations are adjusted for manure applications if accurate manure management information is supplied with the soil samples. Examples for determining manure nutrient credits are provided.

Legumes. Legume plants, together with certain soil microorganisms can convert gaseous nitrogen from the air to plant available nitrogen. The most common examples of such plants are alfalfa and soybeans, but trefoil, clovers, beans, and peas are also important in Wisconsin.

A stand condition evaluation is needed to determine the legume credit for forage legumes, while a yield measurement is used for soybeans. For other crops a singular value is used. In some

cases nitrogen credits are affected by soil texture or harvest management.

Use Table 5 to determine the nitrogen credit for legumes. Enter the calculated credit on line 3b. As with manure, if accurate legume cropping information was supplied with soil samples and the University of Wisconsin recommendations are used, the legume credit has already been subtracted. Some examples are provided above.

Residual nitrate. Recent research has shown that in some years, significant amounts of N can remain in the root zone from one year to the next where it can be utilized by the following crop. The amount of “carry-over” N is dependent upon previous precipitation, soil texture, and previous crop management. The preplant soil nitrate test measures residual soil nitrate so that N fertilizer recommendations can be reduced to reflect the soil’s residual nitrate content. This test is recommended for corn grown on medium and fine textured soils, in years of normal or below normal precipitation. The test is most useful in years of corn following corn in a rotation. Standard N credit values should be taken for corn following alfalfa or fields where manure was applied the previous fall or spring. More information on the test and the sampling procedure is contained in UWEX Publications A3512 (*Wisconsin’s Preplant Soil Profile Nitrate Test*) and A3624 (*Soil Nitrate Tests for Wisconsin Cropping Systems*). If a preplant soil nitrate test has been performed, enter the credit on line 3c.

Other nutrients. Nutrients can be credited from other sources if the nutrient content and rate of application of the material is known. Most of these sources would be organic wastes or by-products such as sewage sludge, whey, or cannery wastes. Some inorganic wastes such as papermill lime-sludge or fly ash are recognized for their liming ability, but may also contain significant levels of plant nutrients. Availability of the nutrients in these materials may vary. The available N-P₂O₅-K₂O should be requested from the supplier. Enter the available nutrient content on line 3d.

Total nutrient credit. The Total Nutrient Credits for N-P₂O₅-K₂O can be determined by adding lines 3a through 3d. Fill in the sum for each nutrient at line 3e.

Step 4. Adjusted Nutrient Need

The Adjusted Nutrient Need can be determined for each of the primary nutrients by subtracting the Total Nutrient Credit (line 3e) from the Total Nutrient Need (line 2c). This value represents the amount (lb/a) of available nutrients needed from commercial or non-commercial fertilizer sources. Enter this value under the appropriate nutrient in box 4.

The adjusted nutrient need assumes that nutrients, whether from fertilizer, manure, or some other source, are applied in a manner that will minimize loss. Therefore, management decisions related to placement, timing, source, and method must still be considered. For example, urea-containing fertilizers should be incorporated to reduce the loss of nitrogen by ammonia volatilization. On sandy soils, nitrogen should be sidedressed to reduce the potential loss by leaching.

Over-application of nutrients occurs where nutrient credits exceed nutrient recommendations – or when fertilizer recommendations are developed without assessing (or only partially assessing) nutri-

ent credits. In fields where N credits exceed N recommendations, decrease or omit N additions from manure or other materials, or plant a crop that has a higher N requirement. Where P or K are the nutrients of concern, monitor nutrient build-up by frequent soil testing. High and/or continuous applications of manure lead to elevated soil test P and K levels. This is often the case with fields near the barn. If soil test levels exceed 150 ppm P, every effort should be made to distribute manure to lower testing fields in order to maximize the agronomic benefits of manure-supplied nutrients.

Step 5. Farmstead Nutrient Use Summary

A nutrient management plan for determining crop nutrient need can be developed for any farm. The result of a sound nutrient management plan can be increased economic returns and decreased risks to the environment. After the nutrient needs of individual fields have been determined, it would be helpful to summarize the entire farm nutrient requirements on a single summary sheet. The Farmstead Nutrient Use Summary Worksheet (found at the end of this publication) can be completed by transferring the total nutrient need, total nutrient credit, and adjusted nutrient need information from the field-specific worksheets to the summary sheet. The farmstead worksheet will provide a record of nutrient use on the farm and can serve as a component of a farm nutrient management plan.

To determine the supplemental fertilizer requirement for the whole farm, it may be helpful to group fields by crop and similar adjusted nutrient need. Fields with reasonably similar nutrient needs can be treated alike. For corn production, nutrient applications can most easily be fine-tuned by adjusting the starter (row) fertilizer rate. By grouping similar fields according to nutrient need, a single grade of starter fertilizer for corn could be purchased and applied at variable rates that match field nutrient needs.

Worksheet for a Step-by-Step Guide to Nutrient Management on Your Farm

Complete One Form Per Field

1. Field Information

a) Field ID _____ c) Acres _____ e) Soil name _____
b) Year _____ d) Crop to be grown _____ f) Previous crop _____

2. Nutrient Need

	N (lbs/acre)	P ₂ O ₅ (lbs/acre)	K ₂ O (lbs/acre)
a) Nutrient recommendations soil test report	_____	_____	_____
b) Special nutrient need (from table 1)	_____	_____	_____
c) Total nutrient need	<input type="text"/>	<input type="text"/>	<input type="text"/>

3. Nutrient Credit

a) Manure (from table 2, 3, or 4)	_____	_____	_____
b) Legume (from table 5)	_____	_____	_____
c) Residual nitrate (if test was not conducted enter 0)	_____	_____	_____
d) Other sources (whey, sludge, etc., must have sample analysis)	_____	_____	_____
e) Total nutrient credit	<input type="text"/>	<input type="text"/>	<input type="text"/>

4. Adjusted Nutrient Need

(Total nutrient need - Total nutrient credit)

<input type="text"/>	<input type="text"/>	<input type="text"/>
----------------------	----------------------	----------------------

Other Nutrient Needs

a) Secondary and micronutrients

Specific nutrient _____

Application rate (lb/acre) _____

b) Lime

Application rate (tons/acre) _____

Worksheet for a Step-by-Step Guide to Nutrient Management on Your Farm

Complete One Form Per Field

1. Field Information

a) Field ID _____ c) Acres _____ e) Soil name _____
 b) Year _____ d) Crop to be grown _____ f) Previous crop _____

2. Nutrient Need

	N (lbs/acre)	P ₂ O ₅ (lbs/acre)	K ₂ O (lbs/acre)
a) Nutrient recommendations soil test report	_____	_____	_____
b) Special nutrient need (from table 1)	_____	_____	_____
c) Total nutrient need	<input type="text"/>	<input type="text"/>	<input type="text"/>

3. Nutrient Credit

a) Manure (from table 2, 3, or 4)	_____	_____	_____
b) Legume (from table 5)	_____	_____	_____
c) Residual nitrate (if test was not conducted enter 0)	_____	_____	_____
d) Other sources (whey, sludge, etc., must have sample analysis)	_____	_____	_____
e) Total nutrient credit	<input type="text"/>	<input type="text"/>	<input type="text"/>

4. Adjusted Nutrient Need

(Total nutrient need - Total nutrient credit)

	<input type="text"/>	<input type="text"/>
--	----------------------	----------------------

Other Nutrient Needs

a) Secondary and micronutrients

Specific nutrient _____

Application rate (lb/acre) _____

b) Lime

Application rate (tons/acre) _____

Workspace

Author: Richard P. Wolkowski is an outreach program manager in the Department of Soil Science, University of Wisconsin-Madison, and extension soil science specialist, University of Wisconsin-Extension. Typesetting by Kimberly Binning, Editor, Nutrient and Pest Management program, University of Wisconsin-Madison.“



A Step-by-Step Guide to Nutrient Management is published by the Nutrient and Pest Management (NPM) program. NPM links the research base of the Center for Integrated Agricultural Systems of the UW-Madison College of Agricultural and Life Sciences with Wisconsin’s agricultural community.“

This publication is available from your Wisconsin County Extension office or from: Extension Publications, Rm. 245, 30 N. Murray St., Madison, Wisconsin 53715, Phone 608-262-3346. Contact Extension Publications to determine availability before publicizing.“

University of Wisconsin-Extension, Cooperative Extension, in cooperation with the U.S. Department of Agriculture and Wisconsin counties, publishes this information to further the purpose of the May 8 and June 30, 1914 acts of Congress; and provides equal opportunities in employment and programming including Title IX requirements.“

A3568 A Step-by-Step Guide to Nutrient Management

What Is A Farm Nutrient Management Plan?

Ideally, a farm nutrient management plan is a strategy for obtaining the maximum return from your on-and off-farm fertilizer resources in a manner that protects the quality of nearby water resources. Sounds easy, right? Well in many cases it is. In others, nutrient management planning involves some unique challenges. All plans require thought and understanding between the person developing the plan and the person following the plan—the farmer!



There are basic components to all farm nutrient management plans. These include the following:

Soil Test Reports

Complete and accurate soil tests are the starting point of any farm nutrient management plan. All cropland fields must be tested or have been tested within the last three years. From the soil test results, the base fertilizer recommendations for each field are given.

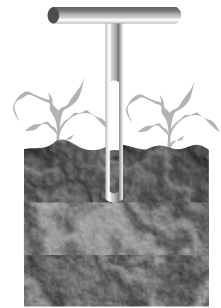

Assessment Of On-Farm Nutrient Resources

The amount of crop nutrients supplied to your fields from on-farm nutrient resources such as manure, legumes, and organic wastes need to be determined and deducted from your base fertilizer recommendations.



Manure applications to fields supply crops with nitrogen, phosphorus, and potassium—as well as sulfur and organic matter. Legume crops such as alfalfa, clover, soybean, etc. supply nitrogen to the crops that follow them.

Nutrient Crediting

Once your on-farm nutrient resources are determined, your commercial fertilizer applications should be adjusted to reflect these nutrient credits. This action will not only reduce your commercial fertilizer bills, but it will also protect water quality by eliminating nutrient applications that are in excess of crop need. It has been shown that excessive nutrient additions to cropland can result in contamination of both ground water as well as lakes and streams.

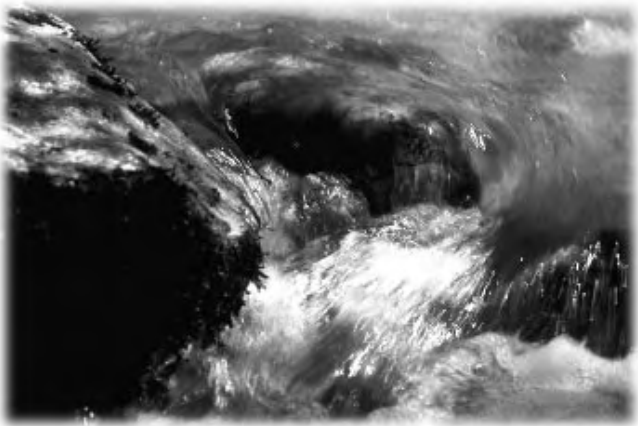

Management skills come into play when determining nutrient credits. For example, to properly credit the nutrients supplied from manure, a grower must know both the manure application rate and the crop-available nutrient content of the manure. To credit the nitrogen available to crops following alfalfa, the condition of the alfalfa stand as well as last cutting date need to be known.

Consistent With Your Farm Conservation Plan

A nutrient management plan needs to be consistent with your farm conservation plan. If you participate in any federal farm programs, you probably have a soil conservation plan for your farm. The conservation plan is another important component of any nutrient management plan for it contains needed information on your planned crop rotations, identification of the slopes of all fields (which is important when planning manure applications), and the conservation measures you are following to maintain your soil erosion rates at “T” or tolerable rates.

In the event that you do not have a soil conservation plan for your farm, or your existing plan farm does not meet “T”, the information contained in a conservation plan will have to be obtained before a nutrient management plan can be developed. This usually means a that revised or new soil conservation plan will need to be prepared for your farm.



Manure Inventory

Probably the most challenging aspect of developing and implementing a farm nutrient management plan is the advance planning of manure applications to cropland fields. This involves estimating the amount of manure produced on the farm and then planning specific manure application rates for individual cropland fields. Sounds challenging—and it is, but there are some tricks to the trade.



One of them is calibrating your manure spreader. This is done using scales—either your own platform scales or portable axle scales available from your county Extension or Land Conservation office. By calibrating your manure spreader, you will know the number of tons of manure your spreader typically holds. Once this is known, a specific number of spreader loads can be applied to a given field in order to deliver a planned manure application rate.

Manure Spreading Plan

The majority of any nutrient management plan for farms with livestock will deal with a manure spreading plan. The amount of manure the farm produces has to be applied to fields in a manner that makes sense both environmentally and agronomically.



Planned manure applications should be made at rates that do not exceed crop nutrient need as identified in the soil test report. The nutrient management plan will also prioritize those fields that would benefit the most from the manure-supplied nutrients while posing little threat to water quality. Also, the nutrient management plan will identify those fields that have manure spreading restrictions. Examples of such restrictions would be fields adjacent to lakes and streams, sloping fields where the threat of spring runoff prohibits manure applications in the winter, and fields in the vicinity of wells, sinkholes, or fractured bedrock.

Manure Spreading Plan (continued)

The seasonal timing of manure applications to cropland will also be identified in the farm nutrient management plan. The timing of planned manure applications will depend upon each farm's manure handling system. Manure application periods for a farmer with manure storage will be significantly different than that of a farmer who has to haul manure on a daily basis.



The 590 Nutrient Management Standard

You may have heard or read about something called the “590 standard” and you might be wondering what it is and what it has to do with nutrient management planning. The 590 standard is a USDA-Natural Resources Conservation Service (formerly Soil Conservation Service) document that defines the minimum requirements and components of an acceptable nutrient management plan. A nutrient management plan meeting the 590 standard is a requirement for participation in some federal and state farm programs involving cost-sharing. A farm nutrient management plan that meets the 590 standard is also a requirement of some county ordinances dealing with the construction of manure storage facilities or livestock expansion.

