

# Field Crop

Integrated Pest Management Program - University of Wisconsin-Extension - Cooperative Extension Service

<http://ipcm.wisc.edu>

## Crop Scouting Manual 2010



**UW**  
**Extension**  
University of Wisconsin-Extension

 COLLEGE OF  
AGRICULTURAL & LIFE SCIENCES  
University of Wisconsin-Madison





# An Introduction to Integrated Pest Management

## Definition

Integrated Pest Management (IPM) can mean different things to different people. As a result, definitions are diverse and have ranged from those which advocate mostly organic control to those which focus on chemical control. One commonly used definition that is easy to understand is the following:

***“IPM is a decision-making process that utilizes all available pest management strategies, including cultural, physical, biological and chemical control to prevent economically damaging pest outbreaks and to reduce risks to human health and the environment.”***

Important concepts of this definition include:

### 1) *is a decision making process...*

IPM is a continuum of management practices that range from simple field scouting to bio-intensive IPM which utilizes a systems approach to crop and pest management. Action thresholds have been incorporated into many IPM programs to assist with the decision making process. Two types of thresholds are commonly used:

#### ***Economic thresholds***

have been developed for crops where yield is the primary concern. The economic threshold is that pest level at which control practices must be implemented to prevent economic damage (i.e. cost of control is less than expected damage).

#### ***Aesthetic thresholds***

are used for crops such as fresh market vegetables, fruits and ornamentals where appearance plays a critical role in the crop's marketability. Aesthetic thresholds are subjective and not absolute. They are driven by consumer preference.

### 2) *that utilizes all available pest management tactics...*

IPM utilizes all available pest control tactics. IPM does not rely on a single tactic to control pests. Some of the problems that result when a single management tactic is used include pest resistance and secondary pest outbreaks. However, preventative non-chemical control tactics should be used, whenever feasible, as a first line of defense.



### 3) to prevent economically damaging pest outbreaks

and reduce risks to human health and the environment. IPM must continue to focus on economic, public health and environmental goals. Public health and environmental protection have been the foundation of IPM since its inception. However, the producer's profitability and livelihood has to be considered in all management decisions. Finding the appropriate mixture can be difficult.

## History of IPM

Although IPM has become a "buzz word" in recent years the concept has been evolving for a long time. In the early years of IPM, pest management was centered around the control of a single pest. This concept, called "Integrated Control", was introduced in the 1950's and used similar philosophies that are used today (i.e., conservation of natural enemies, proper selection of pesticide and host plant resistance). However, IPM differs from Integrated control in at least two areas:

### **IPM focuses on management not control.**

The word control seems to imply that you have power over something and to many people means total eradication. Conversely, management implies a less threatening method of dealing with pests.

### **IPM is concerned about the whole cropping system.**

Integrated Control dealt with the management of a single pest species. Consideration must be given to how one management practice impacts other components of the system. For example, crop managers are concerned about the frequent use of fungicides for disease control in potatoes because their use can increase aphid populations by inhibiting natural fungal pathogens of the aphids.

## Components of an IPM Program

**Crop scouting** is one of the major components of an IPM program, if not its foundation. The goal of crop scouting is to provide accurate and unbiased pest and crop development data. Without this information an intelligent pest management decision cannot be made. A crop advisor must have a thorough understanding of crop growth/development, key pests and their life cycles. Additionally, the crop advisor must know how the environment affects each of these components. Only after this information is collected can an appropriate pest management decision be made.

**Pest prevention** is another key component of an IPM program. This implies that action be taken against the pest before economic damage is reached and in some cases before a pest problem is even detected. This can be accomplished in a number of ways including physical, cultural and biological controls. These practices should be implemented prior to the use of therapeutic controls (i.e. chemical control). Therapeutic controls are recognized as a necessary component of IPM programs. However, all appropriate non-chemical control options should be implemented before pesticides are recommended.

**Multi-disciplinary research and education**, are also necessary components of an IPM program and are required to move IPM along the continuum. Although IPM has achieved significant accomplishments, it has a long way to go. Without the above components, IPM will continue to be a management system that is chemically based. As new management methods become available they must

be worked into existing programs through education. IPM programs should not be viewed as static; they are constantly changing. What is considered an IPM program today may be considered outdated technology in three years. Growers and crop advisors must be ready and willing to adapt new technologies into their farming enterprise.

## Where to Go for Help Diagnosing Plant Problems

The University of Wisconsin-Madison offers several diagnostic services for crop advisers. Listed below are those services and contact information. Some diagnostic services are free of charge and others have fees to cover staff time and laboratory supplies. For current fee structures please visit their websites.

Name	Services available	Website	Mailing address	Phone number	email
University of Wisconsin- Soil Testing Labs	-Feed and Forage analysis -Soil Testing -Plant Analysis -Other Greenhouse related analysis	Madison <a href="http://uwlab.soils.wisc.edu/">http://uwlab.soils.wisc.edu/</a>	Soil & Plant Analysis Lab 8452 Mineral Point Road Verona, WI 53593-8696	(608) 262-4364	See website for individual addresses
		Marshfield <a href="http://uwlab.soils.wisc.edu/">http://uwlab.soils.wisc.edu/</a>	UW Soil & Forage Analysis Laboratory 2611 East 29th St. Marshfield, WI 54449	(715) 387-2523	
UW Weed Identification	Weed Identification	Interactive Weed identification Data Base for Wisconsin <a href="http://weedid.wisc.edu">http://weedid.wisc.edu</a>	Mark Renz Dept. of Agronomy, 1575 Linden Dr., Madison, WI 53706	(608) 263-7437	mrenz@wisc.edu
UW Plant Disease Diagnostic Clinic	Identification of Plant Diseases	<a href="http://pddc.wisc.edu/">http://pddc.wisc.edu/</a>	Plant Disease Diagnostics Clinic Department of Plant Pathology University of Wisconsin-Madison 1630 Linden Drive Madison, WI 53706-1598	(608) 262-2863	bdh@plantpath.wisc.edu
UW Insect Diagnostic Laboratory	Identification of insects and their damage	<a href="http://www.entomology.wisc.edu/entodiag.html">http://www.entomology.wisc.edu/entodiag.html</a>	Insect Diagnostic Lab 240 Russell Labs 1630 Linden Drive Madison, WI 53706	(608) 262-6510	pellitte@entomology.wisc.edu



# Collecting and Submitting Plant Disease and Insect Specimens

## Proper disease and insect identification requires two basic steps:

1. Gathering the pertinent background information. Detailed use of the submission form is necessary.
2. Studying the affected plants properly; and properly collecting and submitting plants to a diagnostic laboratory when this is necessary.

## Suggestions for collecting and submitting plant specimens:

1. Whenever possible, you should collect the specimens yourself, so that you can examine the field or crop area concerned, and can examine healthy as well as diseased plants.
2. Examine all parts of the plant(s), including the roots if at all possible.
3. Dig plants—do not pull them.
4. Send immediately after digging—do not let plants lie around for a period of time before packaging and sending.
5. Send in the entire plants when feasible. \*\*
6. When possible, submit plants or plant parts showing the range of symptoms—healthy, slightly and seriously affected.  
\*\* Remember leaf abnormalities are often symptomatic of a problem in some other part of the plant.
7. See directions for packaging on the following pages
8. Collect and send specimens during the early part of the week to reduce the chance of weekend delay and deterioration.
9. Submitting Insect Specimens for identification.
  - A) For Beetles and True Bugs. Place dead specimens in a clean, small vial. Within twelve hours after death insects become very dry, hard and brittle. Appendages such as antennae, which are important characters for identification, are easily broken. Cotton or tissue paper inside the mailing tube will cushion the specimen in transit, and increase the chances of the specimen arriving in one piece.
  - B) Adult moths, mosquitoes and other insects covered with fine scales or hairs should be kept dry. Proper identification is very difficult if scales or hairs are rubbed off. Again, handle with care, and use some form of “padding” for shipment, after placing specimen in a vial.
  - C) For Caterpillars and other worms and maggots. The simplest and best method of killing these larvae is to drop them into very hot or gently boiling water and then transfer them immediately to alcohol. This will preserve both their shape and color (color is often an important character for species determination). Alcohol alone may be used as a killing agent, but it may cause discoloration. Seventy percent ethanol is the best liquid preservative, but rubbing alcohol (which is available in local drugstores) is satisfactory. Both aftershave lotion and clear cocktail alcohol such as gin will work in a pinch.
  - D) Small soft bodied insects such as aphids or leafhoppers should be put directly into and shipped in alcohol. Glass or plastic prescription bottles (often available in quantity from local pharmacists) make good storage containers only if they are sealed to prevent leakage and if they are packed within a sturdy box or mailing tube. The mail is very rough on unprotected glass.

The recommendations for submitting insect damaged plant material are the same as for diseased specimens.

## Packing Specimens for Submission

Pack all specimens in outer carton with packing so they do not bounce around. Mail early in the week so packages do not sit in post office over a weekend.

### Potted Plants

- Place pot into plastic bag.
- Secure around base of stem with straws or twist 'em.

### Entire Plant

- Wash roots.
- Wrap roots in paper towel and then in plastic bag and secure around base of plant.
- Aerial portion in flat position in alternate layers of moist (not wet) and dry newspaper with moist layer next to plant.

### Aerial Portion of Herbaceous Plant

- Lay as flat as possible between layers of newspaper.
- Layer next to plant may be slightly moist.
- Use cardboard for outer layers.

### Single Leaves

- Press flat between alternate layers of moist (not wet) and dry layer next to leaf.
- Cardboard for outer layers.

### Fleshy Fruits and Vegetables

- Wrap in dry newspaper.
- Place in perforated plastic bag.

# Degree Days — What Do They Mean?

*David Hogg, Entomology*

Degree days (also known as “day-degrees” or generically as “heat units”) provide a means of predicting insect phenology (i.e., the timing of life history events) by combining time and temperature to measure insect development and activity. The utilization of degree days is becoming increasingly important in insect pest management programs, due to the potential for increased accuracy over calendar time in predicting phenological events. Applications to pest management include the scheduling of pest scouting and in some cases insecticide applications or other types of control tactics.

## Theoretical Basis

The degree day concept is based on the fact that insects are cold-blooded, and thus an insect’s body temperature is similar to the temperature of the surrounding environment. As a result, the physiological activity of insects is governed largely by environmental temperature. This is illustrated most vividly in the case of the development of the immature stages of insects. The relationship between the rate of immature development and temperature is shown in a general way in the figure below.

For convenience, the relationship has been divided into three regions. In B, the relationship between developmental rate and temperature is linear. In A, the relationship begins to deviate from linearity, and as cooler temperatures are encountered the rate slowly approaches zero (no development). In C, the relationship also begins to deviate from linearity, and as warmer temperatures are encountered, the rate reaches a maximum and then begins to decline.

Temperatures in the linear portion of the temperature-rate relationship generally are the most favorable for insect survival and development, and in most cases the life history of an insect species is geared so that the insect is active when temperatures in this region are encountered most commonly. Although higher temperatures (region C) may promote faster development, prolonged exposure to these conditions usually results in excessive mortality.

In developing a degree day scale, the linear region of the temperature-rate relationship is utilized. The assumption is made that the relationship remains linear in region A, and a base temperature or “developmental threshold” (i.e., the temperature below which no development is assumed to occur) is determined by extrapolation of the linear relationship (see figure). The importance of assuming linearity is that, by so doing, the number of degree days required to complete development will be the same regardless of temperature. Of course, the details of the temperature-rate relationship will vary depending on the insect species; for example, the pea aphid has developmental threshold of about 38°F, whereas the corn earworm has a threshold of about 56°F. The threshold and degree day requirements for each species and stage of interest can be determined experimentally.

## Calculating Degree Days

A degree day can be defined as one degree of temperature above the threshold for one day. There are several methods available for calculating degree days. The easiest is to use the high and low temperatures for the day, calculate an average temperature, and subtract the threshold:

$$[(\text{High} + \text{Low}) / 2] - \text{Threshold} = \text{Degree Days for one day}$$

For example, if a threshold of 50° is used, and a high of 80° and a low of 60° have been recorded, the number of degree days for the day would be:

$$[(80 + 60) / 2] - 50 = 70 - 50 = 20$$

This procedure is accurate as long as the low temperature is greater than or equal to the threshold. However, if the low temperature is less than the threshold, this procedure underestimates the actual number of degree days. When this occurs, there are several other methods available for calculating degree days. One of these is known as the “modified” degree day method, in which the low temperature is set equal to the threshold whenever the low is less than the threshold, and degree days are calculated as before. A drawback to this method is that it tends to overestimate the actual number of degree days. A more accurate procedure is known as the “sine wave” method. A sine curve is fit through the daily high and low temperatures, and the area under the curve and above the threshold equals the number of degree days. The sine wave method is also the most difficult to calculate, requiring a computer or at least a programmable calculator. One approach to overcome computational difficulties is to prepare a table that gives the number of degree days above some threshold temperature for every possible combination of high and low temperatures. Daily degree day accumulation can then be determined simply by referring to the table.

On a seasonal basis, degree day accumulation (a process known as “thermal summation”) normally starts the first day the temperature goes above the developmental threshold. After that, a running total of accumulated degree days is kept.

## Applications

For degree days to be useful in a management program for a particular insect pest, two criteria must usually be met. First, the pest must overwinter locally; in Wisconsin this is accomplished by hibernation in a physiological condition known as diapause. Examples of insect pests that are unable to survive the winter in Wisconsin are the potato leafhopper and the corn earworm. These species overwinter only in



areas well to the south of Wisconsin, and each year both migrate into the state. Usually the potato leafhopper arrives during May and the corn earworm arrives during August, but the arrival times of migrants are not predictable enough to calibrate with degree day seasonal totals. The second criterion is that the pests have discrete generations. For example, the pea aphid overwinters in Wisconsin; however, the aphids have very short generation times and reproduce continuously, so that in a short time the generations overlap. As a result, all aphid stages are present in the field during virtually the entire growing season, and aphid abundance is related to factors other than degree day totals.

Two pest species that meet both criteria and for which degree days have proven useful in management programs are the alfalfa weevil and the European corn borer.

The alfalfa weevil is a pest of first crop alfalfa in Wisconsin. It overwinters in the adult stage. In the spring the adults come out of hibernation, feed and lay eggs. It is feeding by the larvae that hatch from these eggs that can cause significant damage to the crop. Only one generation of larvae occurs each year, and it either is completed by the time the first cutting is taken or is interrupted when the field is cut. The developmental threshold of the alfalfa weevil is 48°F. In southern Wisconsin damaging populations of weevil larvae do not occur until a seasonal total of at least 300 degree days above 48°F has been accumulated; thus, in southern Wisconsin it is recommended that scouting for alfalfa weevil be initiated when a total of 300 degree days is reached.

The European corn borer is a pest of field and sweet corn in Wisconsin. The corn borer overwinters as a mature larva. In the spring the larvae pupate, emerge as adults, and lay eggs. Two discrete generations of this pest are normally completed during the growing season in southern Wisconsin. The developmental threshold of the European corn borer is 50°F. Seasonal degree day (DD) totals above 50°F for various events in the seasonal history of the corn borer in southern Wisconsin are given in the following table:

<b>First (Spring) Generation</b>	<b>DD</b>
First moth	374
First eggs	450
Peak moths	631
Treatment period	800-1000
<b>Second (Summer) Generation</b>	<b>DD</b>
First moth	1400
First eggs	1450
Peak moths	1733
Treatment period	1550-2100

The values in the table represent averages of 5 years of data collected by J.W. Apple (formerly of the U.W. Entomology Department) at the Arlington Experimental Farm. Also shown in the table are the periods during which insecticides should be applied if treatment is warranted; the timing of treatments is important because once corn borer larvae bore into the plant, they are no longer vulnerable to insecticide applications.

## Conclusion

Degree days, by combining time and temperature, provide a much more accurate means of measuring insect activity and development in the field than does calendar time alone. Because of this capability, degree days can be useful in the development of management programs for certain insect pest species.

There are, however, several potential problems in using degree days that should be mentioned. As discussed earlier, the degree day concept is based on the linear portion of the temperature-rate relationship. If temperatures are consistently either above or below the linear range, errors in prediction are likely to arise. Another potential problem is that temperatures used to calculate degree days generally are ambient (air) measurements, whereas the temperatures in the insects' microenvironment may

be quite different than ambient. However, in most cases, degree day scales are calibrated in the field, so that discrepancies between microenvironmental and ambient conditions are accounted for in the scale. Finally and most pragmatically is the problem of where to obtain temperature data for calculating degree days. Ideally, temperatures should be recorded in or near the field where the pest population of interest occurs. Unfortunately, often this is not possible. The only advice that can be offered is that preliminary measurements be made to ensure that conditions between locations do not deviate significantly. Otherwise, there is the danger that the “wrong” temperature will be used.

## Contents

Chapter 2: Alfalfa . . . . .	1
Scouting Calendar . . . . .	2
Alfalfa Pest Management Form . . . . .	3
Quick Reference Photos. . . . .	4
Insect Profiles . . . . .	5
Alfalfa Blotch Leafminer . . . . .	5
Alfalfa Weevil . . . . .	6
Clover Root Curculio . . . . .	8
Occasional Pests of Alfalfa . . . . .	9
Meadow Spittlebug <i>Philaenus spumaris</i> (Linn.) . . . . .	9
Alfalfa Caterpillar <i>Colias eurytheme</i> . . . . .	10
Pea Aphids <i>Acyrthosiphon pisum</i> . . . . .	11
Plant Bugs. . . . .	12
Alfalfa Plant Bug . . . . .	13
Tarnished Plant Bug . . . . .	13
The Potato Leafhopper . . . . .	15
Quick Reference Photos. . . . .	17
Alfalfa Disease Management . . . . .	18
Disease Profiles . . . . .	19
Winter Injury . . . . .	19
Heat and Drought Injury . . . . .	21
Tractor Damage . . . . .	21
Genetic Rough Rot . . . . .	21
Leaf and Stem Diseases . . . . .	22
Leptosphaerulina Leaf Spot . . . . .	22
Common Leaf Spot . . . . .	23
Spring Black Stem and Leaf Spot . . . . .	24
Summer (Cercospora) Black Stem . . . . .	25
Yellow Leaf Blotch . . . . .	25
Downy Mildew . . . . .	27
Stemphylium or Zonate Leaf Spot. . . . .	28
Rust . . . . .	29
Alfalfa Mosaic . . . . .	30
Anthracnose . . . . .	31
Reducing Losses from Leaf and Stem Diseases . . . . .	31
Vascular Wilts . . . . .	32
Bacterial Wilt. . . . .	32
Fusarium Wilt . . . . .	33
Verticillium Wilt . . . . .	34
Root and Crown Rots . . . . .	35
Phytophthora Root Rot . . . . .	35
Phytophthora - Aphanomyces Root Rot Complex. . . . .	37
Violet Root Rot. . . . .	38
Fusarium Root and Crown Rots. . . . .	39
Management to Reduce Root and Crown Rot Losses . . . . .	40



# Scouting Calendar

## Generalized Calendar for Alfalfa Insect Pests of Wisconsin



# Alfalfa Pest Management Form

Grower: \_\_\_\_\_

County: \_\_\_\_\_

Date: \_\_\_\_\_

Field No./Location: \_\_\_\_\_

Weevil degree days (base 48° F): \_\_\_\_\_

Alfalfa Weevil Larvae: Sample of 40 stems picked at random.

Number of stems with tip feeding \_\_\_\_\_ + 0.40 = \_\_\_\_\_ % tip feeding.

Number of stems with flower buds \_\_\_\_\_, with blossoms \_\_\_\_\_.

Plant height (inches) use 10 plants from original 40:

\_\_+\_\_+\_\_+\_\_+\_\_+\_\_+\_\_+\_\_+\_\_+\_\_ = \_\_ /10 = Av. Ht.

Diseased larvae present? \_\_\_\_\_.

Potato Leafhoppers: Use 20 net sweeps per set.

	<u>Set 1</u>	<u>Set 2</u>	<u>Set 3</u>	<u>Set 4</u>	<u>Set 5</u>	<u>Total</u>	<u>Av./sweep</u>
--	--------------	--------------	--------------	--------------	--------------	--------------	------------------

Number adults

Number nymphs

Pea Aphid: use 20 net sweeps per set.

	<u>Set 1</u>	<u>Set 2</u>	<u>Set 3</u>	<u>Set 4</u>	<u>Set 5</u>	<u>Total</u>	<u>Av./sweep</u>
--	--------------	--------------	--------------	--------------	--------------	--------------	------------------

Number of aphids

Diseased or parasitized aphids present?

Plant Bugs (Tarnished, Rapid, and Alfalfa): Use 20 net sweeps per set.

	<u>Set 1</u>	<u>Set 2</u>	<u>Set 3</u>	<u>Set 4</u>	<u>Set 5</u>	<u>Total</u>	<u>Av./sweep</u>
--	--------------	--------------	--------------	--------------	--------------	--------------	------------------

No. of Plant bugs

Here include alfalfa diseases noted and abnormal growth patterns, observations on spittlebugs, armyworms and cutworm and results of stubble scouting for continuing feeding by alfalfa weevil, and nutrient deficiencies and weeds.

# Quick Reference Photos

## Alfalfa Insects

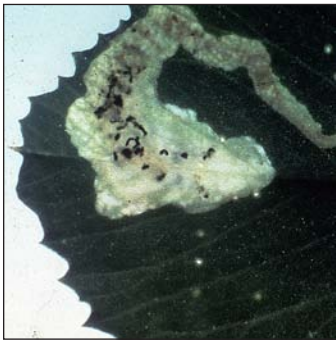

Alfalfa Blotch Leafminer



Alfalfa Weevil  
*Adult/Larvae/Pupae*



Alfalfa Weevil  
*Damage*



Clover Root Curculio  
*Damage*



Meadow Spittlebug *Eggmass*



Meadow Spittlebug  
*Nymph*



Meadow Spittlebug



Alfalfa Caterpillar



Pea Aphid



Pea Aphid



Alfalfa Plant Bug  
*Nymph/Adult*



Tarnished Plant Bug  
*Nymph*



Tarnished Plant Bug



Potato Leafhopper  
*Nymph*



Potato Leafhopper



# Insect Profiles

---

## Alfalfa Blotch Leafminer

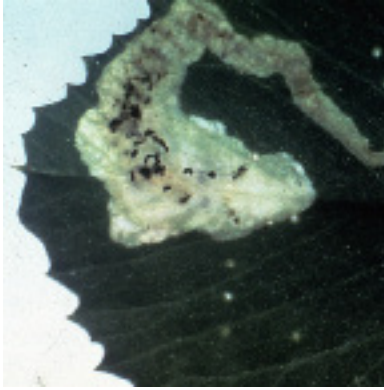

### Identification and Life Cycle

The alfalfa blotch leafminer, *Agromyza frontella* (Rondani), may go through 3-4 generations/year in the upper Midwest. The adult is a black, approximately 1/8-inch long hump-backed fly. The maggots are small and pale yellow. Females will lay 1-3 eggs/leaf. When the maggots hatch, they feed between the leaf surfaces in a mining fashion. When development is complete, larvae will leave the leaf and drop to the ground to pupate.

### Damage

Larval mines can usually be diagnosed through their comma-like appearance. Twenty five to fifty percent of the leaflets may be mined during heavy infestations and this could result in loss of quality. Yield loss is not expected unless significant leaf drop occurs. Adults feed by puncturing tiny “pinholes” in the leaf. This type of damage is usually not considered a plant health problem.

### Scouting and Damage Threshold

Decisions to treat must be made during the adult pinhole feeding stage. Scout fields on a weekly basis to determine the percentage of leaves with pinhole feeding. Control may be necessary when 30-40% of the leaflets show the adult pinhole feeding.

The need for chemical control is difficult to determine. Economic benefits will only be obtained if leaf drop occurs or if a high percentage of the leaflets show excessive feeding. Early cutting can be used to reduce damage and would be most beneficial during first crop. Subsequent cuttings may not coincide with peak larval damage. Biological control has been firmly established and has been very effective in the northeastern United States after the release the introduced parasite *Dacnusa dryas* (Nixon). An indigenous parasitoid has been found attacking Alfalfa Blotch Leafminer pupae in Wisconsin. Parasitism rates of greater than 50% have been found. However, it is uncertain what degree of control this parasitoid may provide on an annual basis.

### Control

Consult UW Extension Bulletin “Pest Management if Wisconsin Field Crops” A3646 for control recommendations. This bulletin maybe purchased from your local county extension office or is available to view, purchase or download from UW Cooperative Extension’s The Learning Store at <http://learningstore.uwex.edu/>

# Alfalfa Weevil



## Identification

Alfalfa weevil adults are small (1/4 inch), light brown in color with a darker brown v-shaped “shield” on their back. Larvae have a black head, a white stripe down their back and will grow to a length of 3/8 inches. Small larvae are slate-colored when small but will eventually become green in color.

## Life Cycle

Alfalfa weevils overwinter as adults in plant debris along fence rows, ditch banks, woodlots, etc. Starting with the first warm spring days they migrate to alfalfa fields and lay eggs in new or dead plant stems. Peak egg lay and larval feeding is usually around early and late May, respectively. Larvae spin a white silken cocoon when development is complete and adults emerge within two weeks. Newly emerged adults will feed on alfalfa foliage for a short time before migrating out of the field to their summer “hibernation” sites. Adult weevils are not active during the summer months but occasionally will be collected in sweep nets. By using degree days, crop advisors and field scouts can monitor alfalfa weevil activity. Begin scouting activity at egg hatch (approximately 300 degree days, base 49°F). An additional 295 (base 48° F) degree days are required to complete larval development (see table below).

## Damage

Some larvae cause damage by chewing tiny holes in the upper leaves. As larvae grow, the amount of foliage consumed increases dramatically. When larval numbers are high, complete defoliation of the upper leaves can occur. Peak damage often occurs when the first cutting is ready for harvest. Significant yield loss can also occur when larvae and/or adults feed on second crop regrowth. Feeding is usually completed by the time second crop regrowth is 8-10 inches tall.

## Scouting and Economic Threshold

Start monitoring alfalfa at 300 degree days. Spot-check sandy knolls or fields with south facing slopes and look for tiny pinholes in the upper leaves. Spot-checking will help determine when to start detailed scouting of all fields.

Life Stage	Degree Days Required to Complete Indicated Life Stage	Degree Days
egg	300 (base 44° F)	300
1st instar	71 (base 48° F)	371
2nd instar	67 (base 48° F)	438
3rd instar	66 (base 48° F)	504
4th instar	91 (base 48° F)	595
pupa	219 (base 49° F)	814

To make a detailed evaluation of first crop weevil damage, walk an M-shaped pattern and collect 50 stems at random. When finished, carefully look over each stem for signs of weevil feeding. Count all stems that show signs of feeding and divide that number by 50 (total number of stems initially collected) to determine percentage tip feeding. Control is suggested when 40% or more of the stems show signs of weevil feeding.

Check alfalfa regrowth 4-5 days after cutting for signs of weevil injury. Remember that dry weather, as well as weevil feeding, can delay regrowth. Look for larvae (or adults) on the soil surface around alfalfa crowns. They often can be found under leaf litter or at the juncture between soil and the alfalfa crown. During cool, cloudy weather you may find weevils feeding on new alfalfa buds during daylight hours. It is difficult to make control decisions based on the number of larvae found. A better method is to take another stem sample, as you did with first crop, and treat the field when 50% of the stems have feeding injury. Before deciding to spray, use an insect sweep net to make sure weevils are still present. Natural control factors can significantly reduce weevil numbers or the weevils may have formed a cocoon and will no longer be causing damage.

## **Control Methods**

There are several natural enemies that do an excellent job of controlling the alfalfa weevil. Which is why insecticides are recommended only as a last resort and then only when significant yield losses are unavoidable. Several small, non-stinging species of wasps have been introduced by the Wisconsin Department of Agriculture, Trade and Consumer Protection and can be responsible for keeping weevil populations below treatment levels. There is also a fungal pathogen that attacks weevil larvae and can decimate weevil populations in a few days. Although these natural control factors are effective, conditions may not always be favorable for acceptable results. Always use timely field scouting before making control recommendations.

If 40% tip feeding is found more than 7-10 days prior to the suggested harvest date, the field should be sprayed as soon as possible. Although "early" harvest is an excellent way of killing alfalfa weevil larvae, harvesting too early could be detrimental to alfalfa stands. Also, growers may not be able to harvest fast enough to stay ahead of weevil damage. In these cases, growers may have to spray the most heavily infested fields and harvest those with lighter infestations. There are a number of insecticides registered for alfalfa weevil larval control. However, if you have adult weevils, select an insecticide that is labeled for adult control. Pay close attention to pre-harvest restrictions. These restrictions vary according to the insecticide used and the rate at which it is applied.

Consult UW Extension Bulletin "Pest Management of Wisconsin Field Crops" A3646 for control recommendations. This bulletin may be purchased from your local county extension office or is available to view, purchase or download from UW Cooperative Extension's The Learning Store at <http://learningstore.uwex.edu/>

---

# Clover Root Curculio

The clover root curculio, *Sitona hispidula* (F.) is of foreign origin and was first discovered within the United States in New Jersey during 1876. Since that time it has spread to many of the alfalfa and clover producing areas.

In Wisconsin, this pest can be found in most clover and alfalfa fields but high populations and serious damage have been localized and sporadic. However, it is possible that low level populations have contributed to stand declines. At this time there is no reliable method of damage prediction or control.



## Identification

The adult is a black to dark brown, blunt-snouted weevil approximately 1/8 inch long and 1/16 inch wide. Red, brown or gray scales are present on the upper surface. The surface is also deeply “punctured”.

Eggs are small and white to yellow when first laid, but turn black within 1-2 days. They are either deposited on stems, the undersides of lower leaves, or on the soil surface.

Larvae are small, white, fleshy, legless, slightly tapered grubs with a light-brown head. They are approximately 1/4 inch long when fully grown.

## Life Cycle

There is only one generation per year, and although there may be a few overwintering eggs, the adult (beetle) is the primary overwintering stage in Wisconsin. They locate under plant debris in alfalfa and clover fields, pastures, and uncultivated waste areas.

Adult activity and egg laying begin with the first warm days of spring. Although mating has been observed at 40°F, the beetles are most active at temperatures from 50-75°F. Research indicates that peak egg laying will be over by early- to mid-June. Spring-laid eggs will hatch within 1-2 weeks but those laid in the fall will not hatch until the following spring. After hatching, the young larvae will move through soil cracks and begin to feed on roots. With the exception of fall-laid eggs, adults will begin to appear within 40-45 days after the eggs are laid. Although there is an overlap of overwintered and new spring adults, the old adults die off rapidly in May.

The larval stage lasts 3-4 weeks. Newly emerged larvae first feed on small rootlets and nodules then move to the main root as they mature. Mature larvae leave the roots in June and July and form a pupal cell. Within these cells, the larvae will change into beetles in approximately 10-20 days. These new adults move to the surface and begin to actively feed on leaves. During hot summer weather they will remain relatively inactive on lower plant parts and the soil surface. Mating commences in early autumn and continues until the arrival of winter.

## Damage

Although adults are capable of flying, most appear to migrate primarily by crawling from field to field. Adults injure plants either by chewing crescent-shaped notches in the margins of leaves, or chewing the stems and leaf buds of young seedlings. This can weaken seedlings. Feeding injury to mature plants is not important unless adults are numerous. The larvae do the greatest damage, and such damage can be cumulative over the years that a field exists. They destroy small rootlets and nodules and chew out portions of the main root; this latter damage may appear as long brown furrows, and result in partial girdling of the plant. Their damage is believed to reduce the potential longevity of a stand, as well as contributing to winter heaving and providing places of entrance for disease organisms.

Although larval damage has been found as deep as 28 inches below the soil surface, most damage occurs in the upper 6 inches.

## Host Plants

The clover root curculio has been associated with damage to several species of clover, alfalfa, and soybeans. Larvae have even been found on the roots of bluegrass. Although there are no recorded instances of injury to commercial peas in Wisconsin, the adults will probably feed on them as readily as any other leguminous crop.

Although injury to soybeans is uncommon, it can be severe. Adults either feed on leaves or gouge holes in the stem near the soil surface. They can completely defoliate soybeans in rows adjacent to recently plowed clover or alfalfa. Damage can occur throughout soybean fields previously containing alfalfa or clover.

Alfalfa is attractive to, and can be severely damaged by adults and larvae. There have been instances when adults have migrated from clover and destroyed adjacent alfalfa seedlings. However, clovers are the preferred host. In a host preference study (Thompson, 1971), the larvae preferred (in order of decreasing preference) roots of red, white, and alsike clover over those of alfalfa and birdsfoot trefoil. Little damage was noted on the trefoil. Adult preference was similar except that white clover was distinctly preferred over the rest; trefoil was again low in preference. The preferred clover plants may also be more susceptible to attack than alfalfa.

## References

Thompson, L.S. and C.B. Willis. 1971. Forage legumes preferred by the clover root curculio and root lesion nematodes for species of *Trifolium* and *Medicago*. *J. Econ. Entomol.* 64(6) : 151-20.

# Occasional Pests of Alfalfa

## Meadow Spittlebug *Philaenus spumaris* (Linn.)

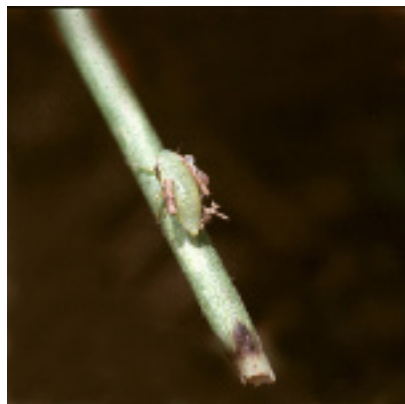



## Identification and Life Cycle:

Adults are 3/8 inch long, wedge-shaped and range in color from pale brown, dark brown, gray or mottled. Nymphs resemble the adults in shape. Early instar nymphs are pale orange to yellow in color and by the fifth instar are green.

There is one generation/year. Meadow spittlebugs overwinter as eggs. When nymphs hatch they form a spittle mass which may be used to prevent desiccation and for protection from predators. Nymphs stay in this spittle mass until late first crop or early second crop, at which time they will become light green in color and can be confused with potato leafhopper nymphs. However, it is uncommon for leafhopper nymphs and spittlebug nymphs to be present simultaneously.

## Damage

Spittlebug damage to alfalfa is uncommon. However, stunting may result when nymphs are present in high numbers.

## Scouting & Damage Threshold

Meadow spittlebugs are common but rarely cause economic damage. An average of 1 nymph/stem is necessary before control is needed. Adults do not damage alfalfa.

---

# Alfalfa Caterpillar *Colias eurytheme*



## Identification and Life Cycle

Alfalfa caterpillars overwinter in the pupal stage and complete 2 generations/year in the upper Midwest. Larvae are dark green and have a small white stripe on each side. Full-grown larvae are approximately 1 ½ inch long. The adult butterfly is yellow with black wing margins and has a wingspan of approximately 2 inches.

## Damage

Alfalfa caterpillars damage alfalfa by feeding on the leaves of second and subsequent cuttings of alfalfa. First signs of damage will be holes in the leaves and/or feeding from the leaf margin in. Under high populations, alfalfa leaves will be partially to completely consumed.

## Scouting

To get an accurate and unbiased estimate of alfalfa caterpillar populations you must use a standard 15-inch sweep net. Walk an M-shaped pattern in the field and take twenty consecutive sweeps in each of five randomly selected areas. The economic threshold is based on the average number of larvae/ sweep. Keep a running total of the numbers caught and divide by 100 (total number of sweeps taken/ field). Treatment is only suggested when you average 10 or more alfalfa caterpillars /sweep. Although alfalfa caterpillars are easily found, economic damage is unusual. An insect virus can spread rapidly and cause high mortality. Early symptoms of viral infection include pale coloration. Infected larvae soon become blackened and can be found hanging from the plant when dead.

---

## Pea Aphids *Acyrtosiphon pisum*



### Identification

Pea aphids, often called plant lice, are green, soft bodied insects which range in size up to 1/8 inch. Adults may or may not have wings. Nymphs resemble adults but are smaller and do not have wings. Pea aphids are easily confused with plant bug nymphs. Plant bugs, as compared to pea aphids, are very mobile and have thicker and easily recognizable antennae. Pea aphids have a pair of cornicles (sometimes called tailpipes) protruding from the end of their abdomen. This is a characteristic that only aphids have. However, these “tailpipes” are hard to see without magnification.

### Life Cycle

Pea aphids overwinter as eggs in alfalfa fields and hatch in early spring. All of these aphids are female. Males do not appear until late summer or early fall. Early season females do not need to mate to reproduce and do not have an egg stage. Instead, they give birth to living young at an extremely high rate when conditions are favorable. Therefore, population explosions are possible. Male aphids appear when days become shorter and mate with female aphids, which will lay eggs capable of surviving our winters.

### Damage

Pea aphids have piercing sucking mouthparts and damage alfalfa by removing plant sap. Symptoms of aphid feeding are 1) stunted plants and 2) possible wilting during hot/dry weather. Damage from aphids can potentially be found in all cuttings. Aphids secrete a sugary substance call honeydew. Although honeydew does not directly affect alfalfa, it is a sign that aphids are present.

## Scouting and Economic Threshold

Because aphid populations fluctuate, the only way to accurately monitor their populations is through the use of an insect sweep net. Walk the field in an M-shaped pattern and take twenty consecutive sweeps in each of five randomly selected areas. Do not take sweeps within 75 feet of the edge of a field. If you are scouting contour strips, we suggest taking sweeps along the middle of each strip. Keep a running total of the number of pea aphids found and divide by 100, which is the total number of sweeps taken for each field. The economic threshold (point at which the amount of damage will exceed the cost of control) is based on the average number of aphids/sweep. When aphid populations exceed 100/sweep, control strategies may be necessary, especially if plants show signs of wilting. Pay close attention to new seedings of alfalfa. Aphid populations frequently build to damaging levels because of the lack of, or longer time period between harvest when compared to established stands.

## Control Methods

Although pea aphids are capable of building to high numbers in a very short period of time, they are considered an occasional pest of alfalfa. Why? Because there are many natural insect predators and parasites which effectively control aphids. Lady beetles, green lacewing larvae, damsel bugs, and parasitic wasps are just some of the important natural enemies of aphids and they can be responsible for keeping aphid populations below economic levels. However, excessive use of insecticides for other alfalfa pests will kill beneficial insects as well as the target pest. Therefore, use insecticides only when economically justified.

In addition to the insect predators and parasites, a naturally occurring fungal disease is also capable of controlling aphid populations when cool/humid weather conditions are present.

When aphid populations reach the economic threshold and you are within 7 days of cutting, an early harvest is an excellent method of control. Our frequent cutting schedule is one of the reasons aphid populations do not frequently reach high numbers. Aphids exceeding the economic threshold can easily be controlled with insecticides that are registered for use on alfalfa. Pay close attention to pre-harvest restrictions. This restriction varies depending on the insecticide used and the rate in which it is applied. Typically these restrictions vary from 7-14 days, although some are longer and some shorter. When selecting an insecticide you should also consider price, potential hazards to honey bees, and whether or not it is a restricted use pesticide. Read the label carefully before applying any pesticide.

Consult UW Extension Bulletin "Pest Management if Wisconsin Field Crops" A3646 for control recommendations. This bulletin maybe purchased from your local county extension office or is available to view, purchase or download from UW Cooperative Extension's The Learning Store at <http://learningstore.uwex.edu/>

# Plant Bugs

The alfalfa plant bug and tarnished plant bug are occasional insect pests on alfalfa. Damage estimates for Wisconsin are difficult to obtain because the Wisconsin Department of Agriculture Trade and Consumer Protection combines plant bug and potato leafhopper damage. However, it is usually agreed upon that plant bug damage potential is quite small, especially when compared to the potato leafhopper. Although individual fields can suffer yield loss when infested with plant bugs.

---

## Alfalfa Plant Bug



### Identification and Life Cycle

The body of the adult alfalfa plant bug is oblong, 3/8 inch long, and green to yellowish-green in color. Nymphs are usually lime green but are occasionally a reddish- orange color and range from 1/16 to 3/8 inch in length. The nymphs closely resemble the adults in appearance except they do not have wings and are smaller. Adults and nymphs feed on a variety of plants. They overwinter as eggs laid in alfalfa stems. The nymphs go through five instars before they turn into adults. In the midwest, there are usually two distinct generations. Peak first generation adults appear between the end of June and mid-July. Peak numbers of second-generation adults occur from early August to early-September.

---

## Tarnished Plant Bug



### Identification and Life Cycle

The tarnished plant bug adult is oval and approximately 1/4 inch long and brown in color. Newly hatched nymphs are approximately 1/16 inch in length and are pale green. Tarnished plant bug nymphs, like alfalfa plant bugs, must go through five instars before they become adults. By the third instar you can see five black spots on their backs. The tarnished plant bug overwinters as an adult and will begin to lay its eggs in alfalfa stems in the spring. There are two generations/year. The first nymphs will appear as early as mid-May with the first generation adult peaking by the end of June to mid-July. The second-generation peak occurs from the end of August to early-September.

## **Damage to Alfalfa**

Adults and nymphs of both species damage alfalfa by sucking plant sap and by leaving some toxic saliva in the plant. It is not fully understood if one species causes more damage to alfalfa than the other. Currently we suggest combining totals of each species when scouting.

Plant bug injury symptoms appear as stunting, malformed, crinkled and/or mis-shaped leaves. They do not cause alfalfa to discolor. The toxic saliva of plant bugs inhibits cell expansion near the feeding site and this is the cause of malformed leaves. However, this symptom can also be found in the absence of plant bug feeding. We have noticed this symptom associated with both cool and hot conditions. If you are not sure if symptoms are a result of plant bug feeding or environmental influence, use an insect sweep net to confirm your suspicions.

## **Scouting**

Because plant bug densities vary from year to year and especially from field to field and because they are highly mobile, the only way to accurately monitor their populations is through the use of a fifteen inch diameter insect sweep net. Walk the field in an M-shaped pattern and take twenty consecutive sweeps in each of five randomly selected areas. Do not take sweeps within 75 feet of the edge of a field. If you are scouting contour strips, we suggest taking sweeps along the middle of each strip. Keep a running total of plant bug numbers (both tarnished and alfalfa) and divide by 100 (the total number of sweeps taken for each field). The economic threshold for plant bugs is to spray when plant bug populations exceed 3/sweep on 3 inch or shorter alfalfa. When the alfalfa is greater than 3 inches tall, the economic threshold is increased to 5 plant bugs/sweep. Do not spray if you are within 7 days of harvest.

## **Control Methods**

There are few natural predators of plant bugs and there is no known varietal resistance. As mentioned in the previous paragraph, an early cut is an effective cultural control measure when the economic threshold is exceeded and you are within 7 days of your normal cutting schedule. When plant bug populations exceed the economic threshold they can be easily controlled with insecticides that are registered for plant bugs on alfalfa. Pay close attention to pre-harvest restrictions. This restriction varies depending on the insecticide used and the rate in which it is applied. Typically these restrictions vary from 7-14 days, although some restrictions are longer and some shorter. When selecting an insecticide you should also consider price, potential hazards to honey bees, and whether or not it is a restricted use pesticide. Read the label carefully before applying any pesticide.

Consult UW Extension Bulletin "Pest Management of Wisconsin Field Crops" A3646 for control recommendations. This bulletin may be purchased from your local county extension office or is available to view, purchase or download from UW Cooperative Extension's The Learning Store at <http://learningstore.uwex.edu/>



---

# The Potato Leafhopper

The potato leafhopper is the most important insect pest on alfalfa in the Midwest. Damage estimates (yield loss + control costs) prepared by the Wisconsin Department of Agriculture, Trade and Consumer Protection in recent years have ranged from as little as \$2 million to as much as \$23 million.



## Identification

Adult potato leafhoppers are 1/8 inch long, wedge shaped, are fluorescent green in color and have wings. Nymphs have the same general appearance as adults except they: 1) can be much smaller, 2) range in color from yellowish-green to fluorescent green and 3) do not have wings. Leafhopper nymphs can also be distinguished from other small green insects because they can walk sideways when disturbed.

## Life Cycle

Potato leafhoppers do not overwinter in Wisconsin, but instead, migrate to the Midwest from the Gulf States on southerly winds. The migration pattern is the reason why it can be difficult to predict their damage potential from year to year. When winds are light, few southern storm fronts develop and/or the winds patterns are shifted to the east or west of our state, we receive relatively few leafhoppers. Although, we may not have widespread problems with leafhoppers in these situations, localized fields may still have significant problems. When migrating conditions are favorable we can have significant problems statewide. Migrating leafhoppers typically arrive in mid to late-May. Therefore, first crop alfalfa usually escapes economic damage. Each generation takes approximately 4-5 weeks to mature and we may experience 3-4 generations/year in the Midwest. Potato leafhoppers can survive and cause economic damage through late summer or early fall.

## Damage

Both adult and nymphs damage alfalfa by sucking plant sap and injecting a toxin back into the plant. This toxin inhibits water and nutrient transport. Damage symptoms appear as stunting as well as yellowing of the leaves in a v-shaped pattern starting at the tip of a leaf. Eventually, these leaves may turn completely yellow or reddish in color.

As a result of this injury, there are several ways leafhopper cause economic damage. They are:

1. Yield loss
2. Quality loss, because the plant produces sugars instead of protein

3. Reduction in overall plant vigor, causing slower recovery of regrowth after harvest, increased stand loss due to winter kill and a potential yield loss the following season when leafhopper populations are high.

## Scouting

Because leafhopper population densities vary from year to year and from field to field, the only way to accurately determine damage potential is by monitoring fields on a weekly schedule. To get an accurate and unbiased estimate of leafhopper populations you must use a standard 15-inch diameter insect sweep net. Walk an M-shaped pattern in the field and take twenty consecutive sweeps in each of five randomly selected areas. The economic threshold (point at which you need to implement a control program) is based on the average number of leafhoppers/sweep. Keep a running total of the number of leafhoppers caught and divide by 100 (which is the total number of sweeps taken in each field). Be very careful when looking for leafhopper nymphs. Usually you will not find them at the bottom of the sweep net (as you would the adults). Instead, they are frequently found around the collar of the net.

The threshold for potato leafhopper is based on plant height, the shorter the alfalfa, the fewer leafhoppers it takes to cause economic damage. If the alfalfa is 3 inches tall, spray when the average number of leafhoppers reaches 0.2/sweep. When alfalfa reaches an average height of 6 inches, the threshold is increased to 0.5 leafhoppers/sweep. When plant height is 8-11 inches or greater than 12 inches the leafhopper threshold is then 1.0/sweep and 2.0/sweep, respectively. Do not spray if you are within 7 days of your normal cutting schedule. Instead, cut the alfalfa and reassess the situation by sweeping the regrowth for leafhoppers.

## Control Methods

There are few natural predators and parasites of the potato leafhopper and those present do not provide adequate and consistent control. However, cutting alfalfa usually kills a high percentage of the nymphs and forces the adults out of the field in search of food. Commercial alfalfa varieties are also available which claim resistance to potato leafhoppers.

Potato leafhoppers are not difficult to control with insecticides. There are a number of registered insecticides that provide adequate control. Consult UW Extension Bulletin "Pest Management of Wisconsin Field Crops" A3646 for control recommendations. This bulletin may be purchased from your local county extension office or is available to view, purchase or download from UW Cooperative Extension's The Learning Store at <http://learningstore.uwex.edu/>.

Pay close attention to the pre-harvest restrictions. This restriction varies depending on the insecticide used and the rate at which it was applied. Typically, these harvest restrictions vary from 7-14 days. Although some restrictions are longer and some are shorter. Also, you should consider price, honeybee hazards and whether or not it is a restricted use insecticide. Read the label carefully before applying any pesticide.

# Quick Reference Photos

## Alfalfa Diseases



Winter Injury



Leptosphaerulina Leaf Spot



Common Leaf Spot



Spring Black Stem and Leaf Spot



Summer (Cercospora) Black Stem



Yellow Leaf Blotch



Downy Mildew



Stemphylium or Zonate Leaf Spot



Rust



Alfalfa Mosaic

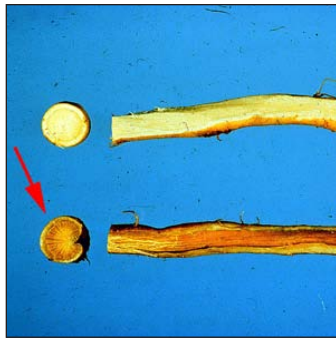

Bacterial Wilt



Fusarium Wilt

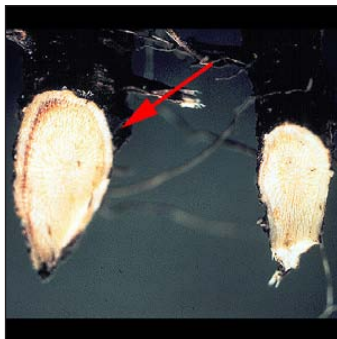

Verticillium Wilt



Phytophthora Root Rot



Violet Root Rot



Fusarium Root and Crown Rot



# Alfalfa Disease Management

*Dr. Craig Grau  
Department of Plant Pathology  
University of Wisconsin-Madison*

Alfalfa diseases may reduce yield and quality of individual plants, but may also deplete alfalfa stands and render them non-profitable. Losses from alfalfa diseases may be sudden and obvious, but, more often, diseases take their toll gradually each year and often without detection. From a distance, foliar symptoms caused by diseases may appear similar and accurate diagnosis is difficult. However, the complete inspection of individual plants, this meaning stems, crowns and roots, enables the investigator to look for key diagnostic characteristics for each disease. In addition to plant symptoms, the time of year, growth stage of the crop, distribution of diseased plants in the field and soil characteristics, are also bits of evidence to use in diagnosis.

Resistant varieties are economical and effective control measures for many alfalfa diseases. Many varieties have resistance to several diseases, thus they can be grown over a wide-range of disease potentials. Although many varieties have good disease resistance, this resistance can be made even more effective if used in conjunction with sound management practices. Disease prevention, not cure, is the situation for alfalfa diseases.

## **Probable occurrence and/or severity of alfalfa diseases by harvest and age of stand.**

Disease	Harvest				Seeding	Year			
	1st	2nd	3rd	4th		1st	2nd	3rd	4th
Pythium Rot	3	1	1	1	3	0	0	0	0
Phytophthora Root Rot	2	3	3	3	3	2	2	2	2
Anthracoese	0	1	3	3	2	3	3	3	3
Verticillium Wilt	3	1	2	3	0	1	2	3	3
Bacterial Wilt	1	1	3	3	0	1	2	3	3
Fusarium Wilt	1	2	3	3	0	1	2	3	3
Spring Black Stem	3	2	0	1	1	3	3	3	3
Summer Black Stem	0	2	3	2	1	3	3	3	3
Common Leaf Spot	2	3	3	3	3	3	3	3	3
Downy Mildew	3	1	1	3	3	2	2	2	2
Fusarium Crown Rot	3	2	2	3	0	1	2	2	3

Probability of occurrence and/or severity.

0 = none

1 = low

2 = moderate

3 = high

# Disease Profiles

---

## Winter Injury



Maintaining stands over winter is one of the really important problems related to the culture of alfalfa in northern areas. Plant losses are the result of temperature in association with free water in or on the soil or in the plant itself. Winterkilling or injury may be the result of one particular condition occurring at one period during the winter or it may be the result of the interrelationship to several conditions occurring at one period or during several successive periods during the winter. All winter injury is not necessarily due to freezing, since some of it results from suboxidation and/or toxic gasses when ice sheets occur. Although abiotic factors are dominant causes of winter injury, biotic agents may interact with abiotic factors and contribute to winter injury.

### Factors affecting winter injury

1. Climatic conditions
  2. Low temperature (5° kill, 17° injury, 26° no injury of plants hardened)
  3. Alternate freezing and thawing (high soil moisture with little surface insulation)
  4. Ice sheets for prolonged periods
  5. Lack of snow cover
  6. Unfavorable conditions for hardening
  7. Warm periods during the winter (reduce hardness, use up reserves)
  8. Late spring freezes
  9. Warm drying winds
- II. Soil conditions
  1. High soil moisture in fall
  2. Topography
  3. Marginal soil fertility; especially potassium
- II. Cultural practices
  1. Late summer and fall seeding
  2. Late fall cutting or grazing
  3. Frequent cutting or grazing
- II. Plant traits
  1. Nonhardy to less hardy varieties
  1. Winter injury increases as plants age



## Symptoms

Symptoms vary with age of the host, the severity of the freezing, and the time after injury that samples are examined. If roots are examined only a few weeks after the freezing, the upper parts of the tap-roots may appear more or less water-soaked but will not be conspicuously softened. It is difficult at this time to assess the damage by mere macroscopic examination of the plants. Sections, however, will show tissue almost completely disorganized; rifts, may extending the entire length of the rays; the larger groups of parenchymatous cells separated into loose aggregations; and, the cells of the cambium region collapsed through coherent. In some plants nearly all of the tissue except the cambium will be disorganized while in others rifts may occur only along the rays. No unusual straining reaction of injured cells may be apparent.

A little later when the frost is out of the ground many of the dead roots will become soft and can be recognized. Damaged living roots may remain fairly firm but will have a much water soaked appearance and when sectioned will show characteristic cell and tissue injury. A faint staining reaction characteristic of winter injury may also be obtained. The dead and injured tissues of live plants do not yet show visible discoloration by which they can be recognized in the field.

As time goes on, the damaged tissues become more and more discolored and the staining reaction more pronounced.

Damage in 1-year old plants is located usually in the phloem fibers. Injury in the exterior of the phloem results in a sheath of damaged tissues surrounding the root, which kill the phellogen or cork cambium exterior to it. Injury in the phloem usually is accompanied by necrosis (browning) of the large cells in the xylem rays in the center of the root. In more severe winter damage, portions of the root near the crown are killed completely or disorganized sufficiently for fungi to enter and rot the tissues. Under such conditions, the plants fail to recover the following spring.

Damage in plants the season or later is largely in the parenchymatous cells of the phloem an phloem rays. The location of the injured cells is different than in the first year, however, as they are located inside rather than outside, the last group of fibers of the phloem. This injury usually extends inward through the cambium and xylem rays of the previous season's growth and results in breaks in the cambium cylinder, but usually the injury does not extend inward to the center of the root. Damage in the sheath of cells immediately beneath the phellogen occurs independently or in conjunction with phloem injury.

Injury of the crown stems is similar to that in the roots. The large cells beneath the phellogen show damage first. Phloem parenchyma is injured as in the root. Crown buds are damaged or killed.

The nature of the injury appears to be due in part to the separation of the cells along the middle lamellae. When extensive, this results in the physiological isolation and death of the tissue. The cells are killed and sometimes ruptured by the freezing. These injured cells and those adjacent respond by biochemical changes and the deposition of brown amorphous substances in and between the injured cells. The injured cells are isolated ultimately by the meristematic activity of the surrounding cells.

Many investigations have been made to correlate or associated some component of the alfalfa plant with the development of winter hardiness. Although no direct correlations have been established it has been suggested that protein and other nitrogenous components may be responsible in part for winter hardiness. It has been reported that the hardening process is accompanied by a marked increase in water-retaining power of the cell colloids and that a higher soluble nitrogen content is present in hardy alfalfa roots than in nonhardy roots. It seems to be true that extreme resistance to cold is associated with the ability of cells to endure desiccation.

## References

1. Jones, F. R. 1928. Winter injury of Alfalfa. *J. Agr. Res.* 37:189-221.
2. Sprague, V. G., and L. F. Graber. 1940. Physiological factors operative in ice-sheet injury of alfalfa. *Plant Physiol.* 15:661-673.
3. Weimer, J. L. 1930. Alfalfa root injuries resulting from freezing. *J. Agr. Research* 40:121-143

---

# Heat and Drought Injury

Two pathological conditions of alfalfa may occur during hot dry periods. One is a yellowing and drying of the tops of individual plants or groups of plants; the other is an extensive dying of buds found associated with restricted terminal growth during the hottest part of the summer.

## References

1. Jones, F. R. 1937. A foliage yellowing and floral injury of alfalfa associated with heat and drought. *Phytopathology* 27:729-730.

---

# Tractor Damage

Significant damage is inflicted on young legume plants when subjected to tractor traffic. Leaves, stems, and crowns are broken and crushed; some parts are completely severed. Damaged plants continue to grow but may be greatly retarded and give poor yields. The greater the area of contact, the more severe the damage; thus smooth tires cause more damage than new tires. Increasing the drawbar pull also increases plant damage. Slippage of the drive wheel is not as important as weight, but the two factors combined inflict more damage than weight alone.

## References

1. Byers, G. L., and R. F. Lucey. 1962. Legume damage by tractors. *New Hampshire Agr. Expt. Sta. Bull.* 473. 14 p.

---

# Genetic Rough Rot

Occasional alfalfa plants suffer from a genetic weakness known as "rough root." This condition is due to the phellogen originating deeper in the cortex than in normal plants, and it remains continuously active like the vascular cambium. The thick phellem thus produced does not appear to protect the underlying cells, and new deeper cambial activity is developed which fails in the same manner.

## Symptoms

The defect does not appear in seedlings until secondary root growth is well developed. Roots become yellow gradually, sometimes in irregular areas, and they may be a quarter of an inch or more in diameter before discoloration is conspicuous and cracks develop. When the roots are cut, the discoloration is found limited to the outer part of the phloem or "bark". The entire root system develops a roughened condition. The roughening is usually least severe at the crown and most severe on the branch roots out to the feeding roots. The latter are normal. Affected plants differ greatly in degree of discoloration and amount of root cracking. Sometimes the plants are small and appear to have been retarded in development, but many appear as vigorous as normal ones at the end of their first summer. Later they lack vigor.

## References

1. Jones, F.R. 1949. Rough root: a heritable character in alfalfa. *Agron. J.* 41:559-561.

# Leaf and Stem Diseases

Although leaf and stem disease occur in almost every alfalfa field, their severity is dependent on periods of wet weather and/or heavy dews. Most leaf diseases of alfalfa are favored by moderate to cool temperatures, and are generally suppressed by high temperatures and low rainfall. Yields may be reduced by leaf and stem diseases, but their main effect is often reducing the nutritional value of the forage because severe leaf disease can cause excessive leaf drop. The leaves of alfalfa plants contain much more protein and are more digestible than are the stems.

---

## Leptosphaerulina Leaf Spot



Caused by the fungus *Leptosphaerulina briosiana*, can be found in alfalfa fields most any time in the growing season.

### Symptoms

The leaf spots (round to oval) are variable from small pin-point, gray-black spots under low light intensity, to larger 1/8" diameter spots with a light tan center, dark margin surrounded by a yellow halo under high light. Affected leaves usually do not die or drop prematurely unless spots are very numerous. Dead leaflets and petioles often remain attached to stems for a time.

### Epidemiology

It is more prevalent during cool, wet weather. It is usually the first leaf spot to develop on regrowth after cutting. The fungus overwinters in leaves on the soil surface. Optimum temperatures for disease are between 60°F and 80°F. Maximum disease follows periods of at least 36 hours of high humidity or leaf wetness.

---

# Common Leaf Spot



Caused by the fungus *Pseudopeziza medicaginis*. Common leafspot occurs wherever the crop is grown. It has been reported from the U.S., Canada, Europe, USSR, and Africa. Some consider the disease of minor importance, but many believe it causes significant yield and forage quality losses.

## Symptoms

(4)Circular, small (rarely exceed 2-3 mm in diam.), brown spots with smooth or dendritic margins occur on the leaflets. These usually do not coalesce or cause discoloration of surrounding tissue. When spots are numerous, the leaflets soon turn yellow and drop off. A dark-brown to black raised disk (apothecium) occurs in the center of the mature spot and is an important diagnostic character. These disks usually occur on the upper side of the leaf, sometimes on the lower side, and rarely on both sides from the same spot. Under moist conditions the disk may appear as a jelly-like drop of exudate. Lower leaves show symptoms first. The disease often occurs on succulent stems as small (1.5-3.0mm), elliptical spots with smooth margins. These are not abundant and rarely form apothecia.

## Host Range

*Medicago sativa*, *M. falcata*, *M. arabica*, *M. globosa*, *M. hispida*, *M. ciliaris*, *M. orbicularis*, *M. scutellata*, *M. truneatula*, *M. tuberculata*, *M. varia*, and *M. lupulina* are some of the hosts (4, 7, 8, 9). *Onobrychis sativa*, several species of *Trigonella*, and *Vicia villosa* have been reported as hosts (4).

## Epidemiology

The disease occurs whenever alfalfa is grown and appears to be most serious on soils that are acid or low in fertility. Seedling stands, especially under thick cover crops (e.g., oats), often become diseased with common leaf spot. Although plants may be severely weakened and stunted the first year, apparently little permanent damage occurs. Disease starts on the lowermost foliage and progresses up the plant. Later cuttings are usually most severely attacked. Common leaf spot is favored by long periods of moist, cool weather (60°-75°F) and so is most often severe on the second cutting, causing leaflets to fall off before cutting. Plants are rarely killed outright by common leaf spot, but defoliation can reduce plant vigor and predispose plants to winter injury. Premature defoliation reduces the quality and quantity of the hay. The causal fungus survives on fallen, undecayed leaves. It is not known to be seed-borne.

## Control

Use of resistant varieties is the best hope for control. Most commercial varieties are susceptible but Caliverde, Dupuits, and a few others have moderate resistance. Individual plants and clones differ

greatly in resistance; some have a high degree of resistance (5, 6). Much work is currently being done to develop resistant varieties. Hay crop should be cut and removed early if disease becomes severe to arrest development of the disease, save the leaves, and remove inoculum from the field.

## References

1. Carnahan, H. L., J. H. Graham, and R. C. Newton. 1962. Quantitative analyses of inheritance of resistance to common leaf spot in alfalfa. *Crop Science* 2:237-240.
2. Davis, R. L. 1951. A study of the inheritance of resistance in alfalfa to common leaf spot. *Agron. J.* 43:331-337.
3. Frosheiser, F. I. 1960. A method for screening alfalfa plants for resistance to *Pseudopeziza medicaginis*. (Note) *Phytopathology* 50:568.
4. Jones, F. R. 1919. The leaf-spot disease of alfalfa and red clover caused by the fungi *Pseudopeziza medicaginis* and *Pseudopeziza trifolii*, respectively. U.S. Dept. Agr. Bull. 759. 38 P.
5. Jones, F. R. 1953. Measurement of resistance to common leaf spot. *Phytopathology* 43: 651-654.
6. Jones, F. R., J. L. Allison, and W. K. Smith. 1941. Evidence of resistance in alfalfa, red clover and sweetclover to certain fungus parasites. *Phytopathology* 31:765-766.
7. Schmiedeknecht, M. 1958. Untersuchungen sur Spezialisierung von *Pseudopeziza medicaginis* (Lib.) Sacc. *Phytopathol. Z.* 32:433-450.
8. Schmiedeknecht, M. 1959. Beitrag zur Eigenschaftsanalyse der Resistenz verschiedener *Medicago*-Arten gegen *Pseudopeziza medicaginis* (Lib.) Sacc. *Der Zöchter* 29:65-72.
9. Schöepp, H. 1959. Untersuchungen über *Pseudopezizoideae* sensu Nannfeldt. *Phytopahtol. Z.* 36:213-269.

---

# Spring Black Stem and Leaf Spot



Cause: The fungus *Phoma medicaginis* var. *medicaginis*.

## Symptoms

Numerous spots develop on the lower leaves, petioles, and stems. These spots are small, dark brown to black, and irregular. Young shoots are often girdled and killed. Leaf lesions may enlarge and merge, killing large areas of the leaflets. The leaves turn yellow and often wither before dropping off. Stem and petiole lesions may enlarge, girdle, and blacken large areas near the base of the plant. Affected stems are brittle and easily broken. When severe, entire stems are blackened and killed.

## Epidemiology

The *Phoma* fungus mostly overwinters as mycelium in old stubble and crop debris where minute, brown to black, pimple-like fruiting bodies (pyrenidia) are produced. Cool, wet weather favors the disease. Infection of new shoots occurs as they grow through the residue or stubble of a previous alfalfa crop. The fungus is also seed borne. In a cool, wet spring, whole shoots are blackened, stems become brittle and break over or are killed. This disease may also cause some losses during cool, wet weather in the fall. Losses are most severe when cutting is delayed.



---

# Summer (Cercospora) Black Stem



Cause: Fungus named *Cercospora medicaginis* (*C. zebrina*).

## Symptoms

Loss of leaves and blackened stems are the most obvious symptoms. Small, brown spots form on both leaf surfaces. Spots enlarge to form leaf spots that are gray-brown with an irregular margin and often are as large as 1/8 to 1/4" in diameter. Tissue around these spots soon turns yellow. These spots are typically located on or near the midrib, often near the tip of leaflets. One spot on a leaflet causes it to yellow and drop within a few days; when severe, leaflets are killed and defoliation is heavy. Plants are not killed in the field by this disease. Elongate, dark brown to black lesions enlarge, merge, and may cover most of the stems and petioles. Infected stems are not as brittle as those attacked by spring black stem, so damage is not as serious.

## Epidemiology

*Cercospora* develops most rapidly at temperatures of 80° to 90°F and near 100% humidity after re-growth is tall enough to shade lower leaves. These requirements make it most serious on the second, third, and fourth cuttings. During cool or dry summers, it causes little loss, but under warm, humid conditions, it is the most serious leaf and stem disease-causing yield losses of 20% or more and reducing quality of the forage as well.

---

# Yellow Leaf Blotch



Yellow leaf blotch is widely distributed in the United States (1) and occurs also in Canada, south America (Argentina), and Europe (Austria, Germany, France, Italy). In Wisconsin, it is most prevalent in the sandy areas of the central part of the state. In most regions and years it is considered of secondary importance, but causes severe defoliation under some conditions. Melchers (3) reported that in many places in Kansas the disease caused losses of 40% of the foliage of the first and second crops. Losses of more than 50% of the leaves have been in occasional fields in Wisconsin.

## Symptoms

Young lesions appear as yellow blotches elongated parallel to the leaf veins. The lesions enlarge, and the color becomes a deeper yellow, often approaching a brilliant orange on the upper surface, and a little paler beneath. Small orange-colored, later dark-brown to almost black, pycnidia are formed in the lesions on the upper surface of the leaf; subsequently, a smaller number of pycnidia may develop in the lesions on the underside of the leaf. Apothecia occur, but except under very favorable weather conditions, do not develop until after the death of the entire leaf. The first apothecia appear as small black dots, rarely as much as a millimeter in diameter on the lower surface of the leaf; later, a few may appear on the upper surface. Stem lesions occur, but appear later than the leaf symptoms and are of less importance. These are elongated yellow blotches which soon turn a dark chocolate-brown. Pycnidia and apothecia have been observed on stems but are not as abundant as on leaves.

## Epidemiology

Yellow leaf blotch occasionally is serious in Wisconsin. The yellow leaf blotch fungus overwinters as mycelium and apothecia in infected leaflets and stems. It is spread mostly by planting infected seed and by air-borne ascospores. Yellow leaf blotch attacks are favored by prolonged, cool, wet spring weather, a thick nurse crop, and succulent, tall, lush growth. Severe epidemics of yellow leaf blotch can occur in the fall, but are less common. Ascospores are produced in the late spring form overwintered apothecia and constitute the primary inoculum. They are produced in decreasing numbers as the growing season advances but become abundant again late in the fall. The cold weather of early spring appears to be unfavorable for their abundant production; and the hot, dry weather of midsummer also has an inhibiting effect. Disease development is favored by prolonged cool periods. Optimum temperature for ascospore germination is 12-26°C; on culture media most mycelial growth occurs at 16-25°C. Conidia have not been shown to incite infection. Little is known about the dissemination of the disease. Jones ( 1 ) thought it likely that ascospores are blown at least short distances by the wind. There is no evidence that the pathogen is carried on the seed as such, but it is likely that if seed contains bits of infected hay the pathogen might be introduced into new areas with seed. Alfalfa is the only species damaged by this fungus. Penetration appears to be direct.

## Control

1. Burning leaves and stubble in early spring helps reduce inoculum. Lodged plants on the field and around its edges form sources of inoculum.
2. Cut hay early when disease is severe to save leaves and reduce inoculum to infect next crop.
3. Commercial varieties are not characterized extensively for reaction to the pathogen, but sources of resistance have been reported (2).

## References

1. Jones, F. R. 1918. Yellow-leaf blotch of alfalfa caused by the fungus *Pyrenopeziza medicaginis*. J. Agr. Research 13:307-329.
2. Jones, F. R. 1949. Resistance in alfalfa to yellow leaf blotch. (Note) Phytopathology 39:1064-1065.
3. Melchers, L. E. 1916. Plant diseases affecting alfalfa. P. 339-353. In Report Kansas State board Agr. Vol 35, No. 138. 484 p.

---

# Downy Mildew



Cause: Caused by the fungus *Peronospora trifoliorum*.

## Symptoms

The most notable symptoms are light yellow to grayish-green blotchy areas on the leaves giving the field a light green appearance. The other fungus leaf diseases of alfalfa generally start on lower leaves and progress up the plant, but downy mildew appears first on the younger leaves near the top of the plant. Downy mildew symptoms can be confused with symptoms of nutrient deficiencies. Infected leaves may be somewhat curled and distorted. Under severe infection, entire stems may be stunted and thickened due to systemic infection. In high humidity, the lower surface of the infected leaves shows patches of gray to violet-gray “downy” growth which are the spore-producing structures of the fungus.

## Epidemiology

Optimum conditions for spore production and infection are near 100% relative humidity and 50° to 65°F. Therefore, this disease is most serious in the cooler, wetter parts of the Midwest, but occurs in warmer, dryer areas during spring and fall. Newly seeded alfalfa is most severely affected. The fungus survives dry summers and cold winters in the crowns of infected plants. Mildew disappears during warm, dry weather, but may reappear during cool, wet periods in the autumn. The mildew fungus persists in systemically infected crown buds and shoots of certain susceptible plants, enabling it to survive from season to season. Weather-resistant spores (oospores) also form in old dead leaves, where they remain dormant over the winter and germinate the following spring. The fungus is also seed-borne.

Control: More than one race of the fungus exists. Downy mildew-resistant varieties are available but are not well documented. Seed treatment with Apron 25W fungicide provides control of downy mildew in the seeding year.

---

# Stemphylium or Zonate Leaf Spot



Cause: Caused by *Stemphylium botryosum* (Pleospora herbarium).

## Symptoms

Small, oval, dark-brown spots appear on the leaves, petioles, stems, peduncles, and pods. The slightly sunken spots later enlarge and often become zoned. They are light and dark brown, often surrounded by a pale yellow “halo”. Infected leaves commonly turn yellow and fall prematurely. Black areas appear on the stems and petioles. Stems and petioles may be girdled in wet weather, causing the foliage beyond to wilt and die.

## Epidemiology

Stemphylium leaf spot is a common disease that develops during prolonged periods of warm, wet weather in the summer and fall, especially in dense stands. The Stemphylium fungus overwinters on seed and as mycelium in plant refuses. The fungus is spread by air- and water-borne spores (conidia and ascospores) and by sowing infected seed.

Stemphylium leafspot is usually a minor disease of alfalfa cut for hay, but it can cause considerable defoliation (1,2). It is most important in fields left for seed.

## Symptoms (2)

All of the above-ground parts of the plant (leaves, stems petioles, peduncles, flowers, pods, and seeds) may show symptoms. Leaf spots are irregular in shape and vary in size (a single infection can involve as much as one-half a leaflet). In early summer, conidia are produced in the lesions incited by ascospores. These are olive-brown to dark-brown. Older lesions from conidial infections are dark-brown and accompanied by increasing necrosis and chlorosis. During moist periods, these lesions become blackened by tremendous numbers of conidia and the leaves appear watersoaked. Lesions commonly coalesce to form large diseased areas. Concentric rings often occur in the older lesions.

Black lesions develop on the stems and petioles. In wet seasons these elongate, coalesce, and frequently girdle entire stems and petioles causing death. Later in the growing season, flowers and seeds may become infected. Infected seeds occasionally are shriveled and dark-colored, but more often the symptoms are less obvious. Deformed pods typically result from floral infections.

## Host Range

*Stemphylium botryosum* comprises more than one race (3). Isolates from *Medicago sativa* severely attack *M. sativa*, *M. hispida*, *Melilotus officinalis*, and *Trifolium hybridum* (2) They also attack *T. pratense* and *T. repens*,

but not so severely. It appears that the race or races occurring on alfalfa are more pathogenic on alfalfa than isolates from red clover and vice versa.

## Disease Cycle (2)

The fungus overwinters as immature perithecia on plant debris and in dormant plant tissues. Ascospores usually are most of the primary inoculum. Some conidia develop in early spring. These become more abundant as the summer progresses. From mid-July to well into the fall, perithecial initials form in the lesions on mature plants and on plant debris, and the life cycle is repeated. Optimum conditions for initial infection are 18°-22°C with 100% relative humidity for at least 12 hours. Subsequent disease development is also greatest at these temperatures. The disease is found in humid climates throughout the world. Spore germination and host penetration are similar for both ascospores and conidia. Penetration is usually through stomata but may be directly between cells or through wounds (3).

## Control

Little attempt has been made to control this disease. Cutting and removal of infected growth in the fall or burning of leaves and stubble in early spring help reduce inoculum. Cut crop for hay instead of saving it for seed in infection is heavy.

## References

1. Benedict, W. G. 1954. Stemphylium leafspot of alfalfa in Ontario. U.S. Dept. of Agr. Pl. Dis. Repr. 38:27-29.
2. Nelson, R. R. 1955. Studies on Stemphylium leafspot of alfalfa. Phytopathology 45:352-356.
3. Smith, O. F. 1940. Stemphylium leaf spot of red clover and alfalfa. J. Agr. Research 61:831-846.

---

# Rust



Cause: Caused by the fungus *Uromyces straitus*.

Rust is usually considered a minor disease of alfalfa, but it may cause important damage in seed fields. The extent of losses depends largely upon the amount of rainfall during the summer and fall. Warm conditions 21°-29°C and high humidity favor the disease (3). Rust is general on alfalfa in North America and Europe, and is probably world wide in the humid temperature zones.

## Symptoms (3, 4)

Reddish-brown spore masses develop within the leaf tissue, rupture the epidermis, and appear as powdery masses (pustules) on the surface. Sometimes a yellow halo surrounds the lesion. Pustules



are commonly scattered over the leaf surface, but may be arranged in a circle about ¼ inch in diameter. When the spores are touched, many adhere to the fingers. Similar pustules may also develop on the stems and petioles.

## **Epidemiology**

Rust is often prevalent on alfalfa during late summer and fall. The rust fungus overwinters in the southern United States and advances northward through the season. High humidity and temperatures between 70° and 85°F favor rust development. These limitations usually delay rust development until late summer or fall.

---

# **Alfalfa Mosaic**



Cause: Alfalfa mosaic virus (AMV).

## **Symptoms**

It causes mottling and yellow streaks between the leaflet veins. Leaflets are often stunted and crinkled and the whole plant is sometimes stunted. Symptoms are most severe during cool weather in spring and disappear during the summer.

## **Epidemiology**

AMV is most severe in the northern parts of the Midwest, but can be found over the whole area. There are numerous strains of the virus with varying symptoms. The virus infects other forage legumes and other plants and is transmitted by aphids. It can be seed-borne. No practical field controls have been developed. The economic impact of AMV has been difficult to determine.

---

# Anthracnose

Cause: The fungus *Colletotrichum trifolii*.

## Symptoms

From a distance infected plants appear straw colored and are scattered through out a field. Leaves are frequently yellow and later turn tan after death. Frequently the tip of diseased stems bends over to form a shepherd's crook. Grayish-brown lesions with purple borders form on the lower portions of stems. Tan centers of lesions form a back ground for black dots that are fruiting structures of the anthracnose fungus. Lesions can run together to cause extensive areas of necrotic tissue. The pathogen can progress into the crown causing crown rot that is usually blue-black in color.

## Epidemiology

The pathogen survives in infected alfalfa crowns or infested hay brought into the field on harvest equipment. Warm, wet weather favors the disease. The disease does not appear in the first harvest but intensifies into fall. The disease can appear in any age stand, but is most prevalent in stands following the seeding year. Anthracnose reduces yield by reducing plant numbers and crown size.

## Control

Resistant varieties are the only practical control. Varieties with moderate to high resistance offer excellent control of this disease.

# Reducing Losses from Leaf and Stem Diseases

Losses in yield from leaf and stem diseases can approach 20-30%, but more typically fall in the 5-10% range. Reduction in protein and carotene content has also been noted. While it has been possible to effectively control diseases by spraying with fungicides, it is probably not economical as a regular practice with current prices and chemicals. Complete control of leaf and stem disease losses is not possible, but the following practices can reduce losses.

- 1. Harvest in late bud and early bloom stage.** Leaf loss from disease is usually minimal up to this stage, but increases very rapidly from this stage on. Scout fields for leaf and stem diseases; harvest fields first that show the greatest disease severity. Cutting before leaf drop maintains the quality of the hay and removes diseased leaves that are a source of inoculum for infection of regrowth.
- 2. Grow adapted varieties resistant to diseases.** (Consult state recommendations for resistance ratings.) While breeding and selection for resistance to many leaf and stem diseases have not developed high levels of resistance, even moderate differences in reaction can reduce disease in the field. Avoid planting known highly susceptible varieties like 'Lahontan' in humid climates.
- 3. Irrigate soon after cutting before much new growth has developed.** Avoid excessive sprinkler irrigation especially after a canopy has developed.
- 4. Practice balanced soil fertility.** Maintain an adequate amount of Potash in the soil, based on a soil test.
- 5. Kocide 101 and Kocide 606 are registered fungicides for leaf disease control.** Their performance has not been evaluated in Wisconsin.

# Vascular Wilts

Three vascular wilt diseases of alfalfa are recognized in Wisconsin. Their incidence and economic impact differ by year, geographic area (topography, soil type, climatic conditions), variety planted, management practices and length of stand life desired. The progress of bacterial wilt, Fusarium wilt and Verticillium wilt is slow the first two years of a stand. Although present early, each disease steadily infects and kills plants and in 3-5 years can render an alfalfa stand uneconomical.

---

## Bacterial Wilt

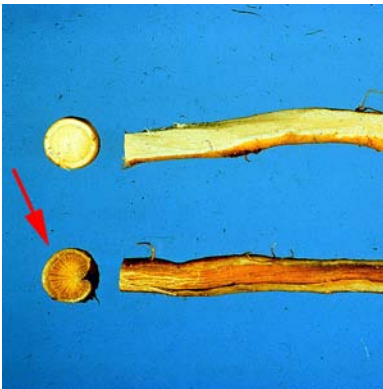

Cause: Caused by the bacterium *Corynebacterium insidiosum*.

### Symptoms

Bacterial wilt causes a stunting and yellowing of the entire alfalfa plant. Diseased plants are dwarfed with numerous fine chlorotic shoots emerging from the crown. Leaflets are cupped, small, rounded at the top, and are light green (chlorotic). Diseased plants may wilt during the heat of the day and recover temporarily during the cool of the night. Plants may wilt and die during warm, dry weather. Plants are increasingly stunted with each harvest. Infected plants usually die from midsummer into the next year. Diseased plants rarely survive the winter.

Root symptoms are very diagnostic. Roots are discolored, yellow to dark brown in the outer vascular tissue of the taproot underneath the bark of the root. Healthy roots are creamy white internally. In time, diseased roots become discolored throughout the root and become soft and mushy. Taproots of dying plants deteriorate rapidly from invasion by secondary rot organisms.

### Epidemiology

Causal bacteria survive in living or dead plant tissue in the soil. Bacteria are released into the soil when plants die. Surface water, harvest equipment, and seed spread the wilt bacteria. Infection occurs during cool, wet weather in spring and early summer. Bacteria enter plants through wounds in roots and crowns or through cut ends of stems as a result of mowing. Bacterial wilt occurs more commonly where soil drainage is poor. It develops slowly with the first symptoms showing the second summer after seeding and gradually renders a stand non-economical within 3-5 years after seeding. Because the disease does not usually become destructive until the third crop year, it is rarely important where alfalfa is grown in short rotation.

## Control

1. Host varieties available today have a level of resistance that allows alfalfa to be maintained for 3 or more years if bacterial wilt is present. However, plants within varieties with high levels of resistance (50%) may express bacterial wilt, but the disease will have a minimal impact on yield and stand life.
2. Good management can improve the effectiveness of resistant varieties. Frequent harvest results in a more rapid death of infected plants. Fall management can influence the performance of resistant varieties. High soil fertility and proper soil pH help maintain vigor of plants to slow the progress of bacterial wilt development.

---

## Fusarium Wilt



Cause: Caused by the fungus *Fusarium oxysporum* f. sp. *medicaginis*.

### Symptoms

Symptoms are yellow, wilted, dead shoots and a thinned stand. These overlap bacterial wilt symptoms except extreme dwarfing or stunting is not caused by *Fusarium*. Bleaching of the leaves and stems follow and a reddish tinge often develops in leaves. Often, only one side of a plant may be affected at first, and after several months and repeated cuttings the plant dies. Diseased plants often do not survive the winter, especially if snow cover is sparse.

Diseased plants exhibit diagnostic internal root discoloration. Dark or reddish brown streaks occur in the vascular tissue, appearing in cross section as partial or complete rings. In advance stages of the disease, the outer ring of the vascular tissue or the center vascular tissue may be discolored and the plant dies.

### Epidemiology

*Fusarium* wilt occasionally affects alfalfa in the warmer growing areas of Wisconsin. *Fusarium* wilt is a more destructive disease in states to the south of Wisconsin. However, the disease can cause localized damage in Wisconsin, especially in sandy loam soils that presumably have higher temperatures during the growing season.

The *Fusarium* wilt fungus produces specialized spores (chlamydospores) in the soil and plant debris. Soil may remain infested almost indefinitely. The fungus infects roots and enters the vascular system of the plant causing reduced growth and eventual death. The disease usually progresses slowly in alfalfa stands as scattered plants. However, considerable stand loss may occur over several years. Like for bacterial wilt, the disease has less of an economic impact if shorter stand life is desired.

## Control

Because the pathogen survives indefinitely in the soil, crop rotation is not an effective control. Planting resistant alfalfa varieties is the only practical control. There is a limited number of resistant varieties that are adapted to Wisconsin.

---

# Verticillium Wilt

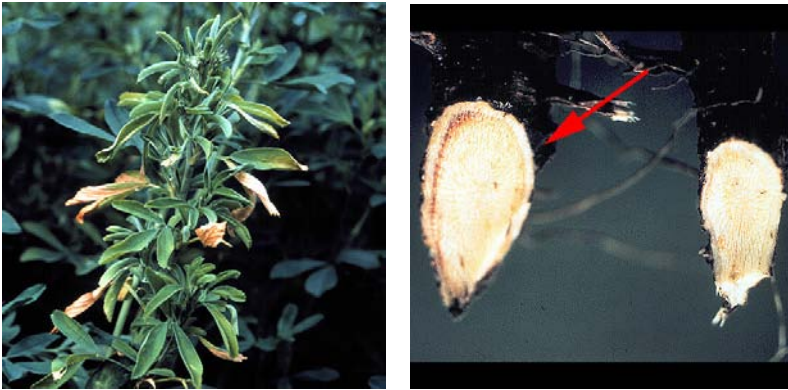

Cause: Caused by the fungus *Verticillium albo-atrum*.

## Symptoms

Early symptoms of Verticillium wilt are temporary wilting of leaves on warm days, and a tan, yellow or pinkish orange discoloration on terminal leaflets. Chlorotic, v-shaped lesions at the leaf tip and following the leaf midrib are common. Entire leaflets become bleached and twisted leading to defoliation. Stems often remain green and erect long after all its leaflets have desiccated. No external symptoms of the disease appear on the roots. Internally, the taproot can show yellow to brown vascular discoloration immediately below the bark of the root.

Verticillium wilt is initially characterized by individual plants showing symptoms and are interspersed among symptomless plants. In time a high number of plants can express foliar symptoms.

## Epidemiology

The pathogen does not survive for long periods of time in the soil. It is introduced into alfalfa fields by infested alfalfa debris carried on harvest equipment, infected seed, infested hay and wind blown spores from other fields. Once plants are infected the pathogen is moved within fields by harvest activities, wind and possibly insects.

Verticillium wilt is rarely observed in the seeding year. However as stands age, the chances of observing the disease greatly increase. Verticillium wilt is favored by cool to moderate air temperatures and ample soil moisture. Thus, symptoms are expressed most in the first harvest and early fall or late summer. This disease can deplete an alfalfa stand and not be evident enough to be blamed. Most plant death occurs during the winter months.

## Control

Planting resistant, winter hardy varieties offers the best control for this disease. Crop rotation is effective, but the disease will occur again unless resistant varieties are planted. Harvesting younger stands first can slow the disease in younger fields, but has limited value.



# Root and Crown Rots

Many different fungi cause decay of roots and crowns of alfalfa. Some are aggressive pathogens and cause distinctive enough symptoms for easy identification. Most, however, occur in complex interactions with several other fungi and it is very difficult to positively identify causal organisms without microscopic examination, isolation and tests for pathogenicity. Some fungi invade roots and crowns but do not cause disease symptoms until the plant is weakened or stressed from poor management, deficiency or excess of water, insects, fertility imbalance or winter injury.

Some root and crown rot can be found on most alfalfa plants but, if vigorous, they can tolerate it by producing new roots to survive. When the pressure from disease and stress become too severe, plants die, the stand is thinned, weeds invade and yield and quality of forage is reduced.

Alfalfa grown in Wisconsin is subject to damage by several root and/or crown diseases. Root and crown disease problems are often the result of a complex of pathogens that can act alone or in combination. Several diseases have characteristic symptoms and are readily diagnosed. However, this is not the case for others, especially in the later stages of disease development. The possibility of non-recognized root and crown-invading pathogens being present is great. The following root and/or crown diseases are recognized in Wisconsin.

---

## Phytophthora Root Rot

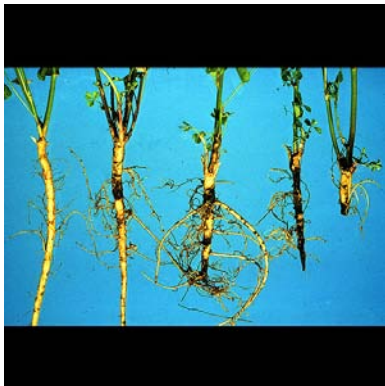

Cause: Caused by a soil-borne fungus called *Phytophthora megasperma* f. sp. medicaginis.

### Symptoms

Alfalfa is susceptible to *Phytophthora* in all stages of growth, but seedlings are more susceptible and die at a faster rate than mature plants. Severely infected plants suddenly become yellow, wilt, and eventually die and turn brown. Some plants may have infected roots, but will not show apparent shoot symptoms. Such plants are less productive and may die if the root decay progresses into the crown. Diseased plants may be scattered throughout the field or, in some cases, every plant in irregular patches may be infected.

The aboveground symptoms described above may be similar to other alfalfa disorders, thus, roots need to be examined for accurate diagnosis of *Phytophthora* root rot. Initially, discrete yellow-brown lesions develop on taproots and become black with time. These lesions can be readily detected on the white roots of younger plants. When roots are cut open, a brown discoloration progressing from the exterior root tissues to the center of the root will correspond to the external lesions. Often roots do not decay entirely, but the root below the lesion is severed from the top portion of the root system. The tip

of the severed root is pointed and has a black discoloration. Lateral roots develop from the remaining taproot, but the root system is less extensive and shallow. When decay is near the crown, the diseased plant can be pulled easily, leaving the rotted taproot in the soil.

## **Epidemiology**

Phytophthora root rot (PRR) is one major cause of reduced alfalfa stands and productivity in Wisconsin throughout the state, especially on heavier soils during wet seasons. Infected plants may more readily succumb to other diseases or stresses caused by adverse weather conditions. Yield and quality losses due to PRR often go undetected. They are frequently misdiagnosed as “winter injury,” “drought,” “flooding,” or other disorders. Phytophthora root rot is caused by a fungus that persists in the soil for years and is most active in soils that are water-logged for periods of 5-10 days. Consequently, Phytophthora root rot is most prevalent in soils with internal drainage problems, bedrock or where erosion has left a clay topsoil with poor drainage. Even fields with well drained soils may have Phytophthora problems during periods of high rainfall.

## **Control**

Alfalfa varieties with increased levels of PRR resistance are now available to Wisconsin growers. Growers should be aware that alfalfa varieties rated as PRR “resistant” do vary greatly in degrees or levels of resistance. Growers should carefully assess the PRR potential on their farms and plant “resistant” varieties in fields or areas of fields where PRR has been diagnosed, or in areas where poor internal drainage enhances the probability of PRR. When Phytophthora root rot potentials are high, varieties rated as resistant (>35% resistance) are necessary to minimize forage loss due to the disease. Varieties rated with moderate to low resistance should be planted in fields with corresponding low to moderate potentials for Phytophthora root rot. For a yearly update, consult the current University of Wisconsin-Extension Publication, Forage Crop Varieties and Seeding Mixtures (A1525) or Pest Control in Forages and Small Grains (A1981).

Tilling and land-leveling, where practical, can reduce PRR by improving surface and subsurface drainage.

Recommended management practices can prolong the productivity and life of infected plants since not all PRR-infected plants may be killed in the initial infection phase. Maintaining high soil fertility can promote extensive lateral root development above the diseased region of the root. Avoid untimely cuttings that will place added stress on the plants. Damage by leaf-feeding insects and leaf diseases can stress plants and render them more susceptible to PRR. Crop rotation is of little value for PRR control because the Phytophthora fungus can survive indefinitely in the soil.

PRR is often most severe in the seeding year. Michigan studies suggest that PRR is less for early planting dates, but is increased at high seeding rates (15 lbs/acre or higher). Lower PRR severity has been observed for establishment with a companion crop compared to direct seeding.

A fungicide is registered as a seed treatment for control of seedling disease caused by Pythium and Phytophthora. It is most effective when used in conjunction with moderate to high levels of Phytophthora-resistance. Varieties which are susceptible to Phytophthora will be protected by the fungicide for only 6-8 weeks.

---

# Phytophthora - Aphanomyces Root Rot Complex

Maximum alfalfa performance is achieved when grown on deep, well drained soils, while severe stand and yield losses can occur on soils that are imperfectly drained. Farmers may have an option to avoid cultivation of alfalfa in poorly drained soils. However, this practice is difficult in Wisconsin since nearly half of all forage production is on soils that are classified as somewhat poorly drained. Although red clover is less difficult to establish in slowly drained soils, many producers favor alfalfa over red clover.

Knowledge has expanded of factors that affect the performance of alfalfa grown in wet soils. This is especially true regarding diseases that reduce productivity of alfalfa in slowly drained soils. Although once believed to be the sole cause of alfalfa root rot, Phytophthora root rot is now believed to form a complex with Aphanomyces root rot resulting in poor seedling and root health of alfalfa when wet soil conditions prevail. These root rot diseases can cause a total establishment failure, but more likely cause a chronic affect on alfalfa health and productivity. The discovery of Aphanomyces and Phytophthora root rots provided a partial explanation of poor alfalfa productivity in many wet soil environments.

The cost of alfalfa establishment has increased in recent years and repeated attempts to establish satisfactory stands can be an expensive endeavor. Thus, it is critical to accurately diagnose causes of poor plant health in the establishment year. In addition to escalated establishment costs, the progressive interaction of stress factors results in a cumulative stress load that degrades plant health in the long-term. Seedlings whose health has been compromised by pathogens are less able to compete and establish during the establishment phase of a forage stand. The effects of seeding year stress can result in lower forage yield the succeeding year or beyond. Thus, it is critical to long-term productivity to get alfalfa stands off to a healthy start.

Symptoms of the Aphanomyces/Phytophthora complex will differ depending on the level of Phytophthora root rot resistance in the variety planted and duration of water saturated soils. Phytophthora root rot is characterized by distinct brown to black lesions on tap roots. These lesions generally girdle and sever the root resulting in a short taproot with a black pointed tip. These symptoms are not common for an alfalfa variety with a moderate or greater resistance rating to Phytophthora root rot. Aphanomyces root rot causes a general decline in health and numbers of lateral roots. Restricted brown lesions on the taproot surface provide evidence that lateral roots were present, but have been rooted back to the taproot by the pathogen. The loss of lateral and fibrous roots comprises the health and efficiency of the alfalfa plant. Distinct lesions are not common on taproots, but rather large sections of the taproot express a soft yellow-brown decay. The absence or presence of decayed nodules is typical of Aphanomyces root rot. Foliage of infected plants becomes chlorotic and resembles symptoms of nitrogen deficiency. Infected plants are often slow to, or may fail to resume growth after harvest or winter dormancy. Thus, a major symptom of Aphanomyces root rot is poor seedling vigor in the seeding year, and less than expected forage yield. The Aphanomyces/Phytophthora complex is more difficult to diagnose in established stands.

Alfalfa establishment problems may involve soil pH, herbicide carry over, poor seed bed preparation, autotoxicity and plant pathogens. Thus, it is important to conduct a thorough investigation of the situation. One approach is to test soils for the presence of the Aphanomyces root rot fungus. Collect one gallon of soil from problem areas in a field. Thoroughly mix the soil and reduce the sample volume to one pint/20 acres of land. Place the soil in a sealed plastic bag or, if a paper bag is used, place this bag inside a plastic bag for shipment. It is not necessary to refrigerate soil samples, but samples should keep away from excessive heat. Send samples to the Plant Pathogen Detection Clinic, 1630 Linden Drive, Department of Plant Pathology, University of Wisconsin-Madison, Madison, WI 53706. A \$25 fee is requested and the test takes 2 weeks to complete. A positive test for Aphanomyces indicates

that alfalfa varieties resistant to *Aphanomyces* should be considered the next time the field in question is planted to alfalfa.

The discovery of the *Phytophthora/Aphanomyces* root rot complex provided alfalfa breeders additional information for their effort to develop alfalfa cultivars that are better adapted to wet soils. Alfalfa cultivars with dual resistance to *Phytophthora* and *Aphanomyces* root rots are available from most companies marketing alfalfa seed. Alfalfa varieties with resistance to both diseases repeatedly express superior forage yield and persistence when grown in the presence of this disease complex. It is evident that in environments where *Phytophthora* and *Aphanomyces* root rot were severely suppressing yields, the penalty for low resistance to these pathogens is very great. Through genetic improvement of alfalfa for root rot resistance, the expansion or renewal of alfalfa production into regions where slowly drained soils have limited the success of alfalfa establishment and long term productivity. Alfalfa varieties with resistance to *Phytophthora* and *Aphanomyces* root rot are required to maximize stand establishment, plant vigor, and forage yield in Wisconsin. The improved stand survival and long term root health gained through resistance to *Phytophthora* and *Aphanomyces* root rot results in increased yield potential in a broad range of environments.

Apron treated seed is offered by many seed companies. Apron is a fungicide product that reduces the risk of seedling mortality especially in the preemergence phase of seedling development.

---

## Violet Root Rot



Cause: Caused by the fungus *Rhizoctonia crocorum*.

### Symptoms

Symptoms are sudden dying of plants beginning about the time of the second cutting. The disease is primarily a root rot. The main root system becomes completely invaded by the parasitic mycelium and rapidly ceases to function. At the points of penetration, small aggregations of mycelium, the “infection cushions”, may be seen. Minute black sclerotia, just visible to the naked eye, are found on the dying roots. The *Rhizoctonia* stage appears from late summer onwards as a compact felt mat which closely covers the roots and may be recognized readily by its characteristic violet color and its white margins. The mycelium may extend 8 or more inches below the soil line and is abundant also in the crowns of infected plants. The roots rot, their bark becomes loose, and their central cylinders soft and shredded. The plants may become somewhat stunted, turn yellow or brown, and die in circular to irregular patches which enlarge as the disease progresses.

## Epidemiology

It is of little economic importance except under unusual conditions. The disease usually occurs in low areas subject to flooding. It frequently follows root injuries. The fungus apparently survives unfavorable periods as sclerotia in the soil. Violet root rot frequently occurs just prior to the harvest of the second cutting. This occurs most frequently in soils with pH lower than 6.5. Crop rotation to corn, or small grains, gives some control. The violet root rot fungus infects other forage legumes, thus they are not good rotational crops. Liming soils to pH 6.8-7.0 offers some, but not complete control. No varietal resistance has been reported.

---

## Fusarium Root and Crown Rots



Several *Fusarium* species caused alfalfa root and crown rots. Lesions on established plants often start with injuries from freezing, harvesting or insect feeding. They are irregularly shaped, reddish to dark brown and occur anywhere on the crown, taproot or lateral roots. Rot of the center of the crown extending down into the taproot is called heart rot or hollow crown. Rot develops slowly and affected tissues are moist to dry and remain firm so plants often survive moderate amounts of damage. Stress from pea aphid and potato leafhopper increases *Fusarium* severity. Good soil fertility, especially high levels of potassium, reduce *Fusarium* crown rot. Winter-hardy varieties often have less crown rot.



# Management to Reduce Root and Crown Rot Losses

Management of the growing alfalfa for maximum vigor is the key to reducing cold injury and root and crown rot losses. High levels of stored food reserves in the roots are directly related to the plant's ability to withstand and overcome these problems. Variety, soil fertility, soil moisture, harvest time, cutting intervals, irrigation timing and injuries all are part of this complex interaction which affect vigor.

Alfalfa is a heavy user of phosphorus and potash and adequate supplies of these reduce root rot losses. Preplant applications are most effectively utilized. Topdressing established stands is necessary in many areas to achieve maximum yields.

Harvest time and interval very strongly affect carbohydrate reserves in roots, vigor and consequent winter injury and root and crown rot. These effects have been well documented by research with many varieties, climates and growing conditions. Short harvest intervals (frequent cutting at the bud stage) weakens plants, reduces root reserves and encourages cold injury, root rots and stand depletion. Long harvest intervals, especially at the last harvest allow plants to build root reserves and resist these problems.

Under ideal growing conditions it takes about 3 weeks of regrowth (to about the early bud stage after cutting or coming out of winter dormancy) for the new shoots to manufacture enough food to begin replenishing root reserves. Then there is a rapid build-up of root reserves with the maximum reached at about full bloom. Short harvest intervals appear to be tolerated better during mid-season than in early spring or late fall. It is most important to time the last cutting at least 4 and preferably 6 weeks before the first killing frost to permit at least 8-10 inches of top growth to develop. When alfalfa is cut or frozen into dormancy in the late fall while root reserves are depleted, the plants go into winter weakened and unable to withstand freezing and root rot attack. Low yields and thinned stands may result the following year. While it is well established that long harvest intervals will reduce root rots and prolong stands there are some negative results. Protein and carotene decrease and fiber increases after bloom begins. Leaf and stem disease losses increase rapidly. Therefore, selection of cutting time is a compromise between high quality forage along with weakened plants from early cutting and greater yields with better stand maintenance but poorer quality forage with later cutting. It appears that the old rule of thumb to cut at 1/10 bloom strikes the best balance.

## Contents

Chapter 3: Field Corn . . . . .	1
Corn Diagnostic Guide . . . . .	2
Corn Scouting Calendar . . . . .	12
Plant Physiology . . . . .	13
Stage VE Determination of potential ear density . . . . .	14
Stage V6 Potential plant parts (“factory”) developed . . . . .	15
Stage V12 Potential kernel rows determined . . . . .	16
Stage V18 Potential kernels per row determined . . . . .	17
Stage R1 Kkernel number and potential kernel size determined . . . . .	17
Stage R6 Actual kernel weight determined . . . . .	19
Quick Reference Photos. . . . .	21
Insect Profiles . . . . .	22
Armyworm . . . . .	22
Black Cutworm . . . . .	24
Corn Leaf Aphid . . . . .	26
Corn Rootworm . . . . .	28
European Corn Borer . . . . .	31
Hop Vine Borer & Potato Stem Borer . . . . .	34
Seed Corn Maggot . . . . .	36
Stalk Borer. . . . .	38
Western Bean Cutworm . . . . .	40
White Grub . . . . .	42
Wireworm . . . . .	44
Field Crop Insect Stages . . . . .	46
Key: Types of “Worms” Found in Corn & Alfalfa Fields . . . . .	48
Wisconsin Field Pest Caterpillar Key . . . . .	49
Quick Reference Photos. . . . .	52
Corn Disease Management . . . . .	53
Disease Profiles . . . . .	55
Anthracnose . . . . .	55
Northern Corn Leaf Blight . . . . .	56
Northern Leaf Spot . . . . .	57
Goss’ Bacterial Wilt and Blight. . . . .	58
Gilbberella & Fusarium Stalk Rot . . . . .	59
Ear Rot . . . . .	60
Seed Rot & Seedling Blights . . . . .	61
Corn Nematodes . . . . .	61
Gray Leaf Spot . . . . .	64

# Corn Diagnostic Guide

The diagnostic guide has been developed to help identify causes abnormal corn. A wide range of corn problems and symptoms encountered throughout the season are included. For each symptom, concise descriptions of the possible causes are listed. Because different problems are associated with different growth stages this guide is divided into the following four sections:

1) Before emergence; 2) Emergence to Knee-high; 3) Knee-high to Tasseling; 4) Tasseling to Maturity

Realize that this information is intended as a field identification guide to provide a fast and tentative diagnosis of corn production problems. Many of the causes of problems listed here can be positively identified only through extensive sampling and testing, often only in a laboratory. Therefore, use this diagnostic guide as a preliminary source for problem identification and consult other, more complete sources for positive identification before making any management decisions.

## Before Emergence

General appearance	Specific symptoms	Possible causes
Skips in rows plants fail to emerge	No seed planted	<ul style="list-style-type: none"> <li>• Planter malfunction</li> <li>• Empty planter box</li> <li>• Irregular seeding depth</li> </ul>
	Seed not sprouted	<ul style="list-style-type: none"> <li>• Seed not viable</li> <li>• Anhydrous or aqua ammonia injury</li> <li>• Excessive fertilizer (<i>nitrogen and/or potash</i>) placed too close to seed</li> <li>• Soil too dry</li> <li>• Toxicity of seed from applied pesticides</li> </ul>
	Seed swollen but not sprouted	<ul style="list-style-type: none"> <li>• Seed not viable</li> <li>• Soil too cold—50° F (10°C) or lower</li> <li>• Soil too wet</li> </ul>
	Rotted seed or seedlings	Fungal seed rots or blights—for description Anhydrous or aqua ammonia injury
	Sprouts twisted or leaves expanded underground	<ul style="list-style-type: none"> <li>• Soil crusted</li> <li>• Compacted soils</li> <li>• Damage from rotary hoe</li> <li>• Cloddy soil—allowing light to reach seedling prematurely</li> <li>• Seeds planted too deep in cold, wet soil</li> <li>• Chloroacetamide Herbicide injury—alachlor (Lasso), metolachlor (Dual), dimethenamid (Frontier), acetochlor (Harness/Surpass) or premixes</li> <li>• Excessive soil insecticide dosage</li> <li>• Anhydrous or aqua ammonia injury</li> </ul>
Seed eaten, dug up or sprout cut off	Seed hollowed out	<ul style="list-style-type: none"> <li>• Seedcorn maggot</li> <li>• Wireworms—sect.</li> <li>• Seedcorn beetles</li> </ul>
	Unemerged seedlings dug up and entire plant eaten	<ul style="list-style-type: none"> <li>• Mice, groundhogs, ground squirrels, gophers, skunks, rats</li> </ul>

## Emergence to Knee-high

General appearance	Specific symptoms	Possible causes
Scattered problem spots of dead or poorly growing plants	Uneven growth of corn	<ul style="list-style-type: none"> <li>• Drainage problems</li> <li>• Soil compaction</li> <li>• Variation in planting depth, soil moisture</li> <li>• Poor growing conditions (cold, wet, dry, etc.)</li> <li>• Seed bed not uniform (cloddy)</li> <li>• Anhydrous or aqua ammonia injury</li> <li>• ALS-inhibitor herbicide injury—carryover of previous soybean herbicide or injury from soil applied corn herbicide</li> </ul>
	Plants stunted, wilted and/or discolored	<ul style="list-style-type: none"> <li>• Nematodes—microscopic, wormlike organisms, several species of which live in the soil and are parasitic on corn roots</li> <li>• Damping-off and seedling blight pathogens</li> </ul>
	Roots on newly formed crown are discolored and decayed. Limited lateral root development	<ul style="list-style-type: none"> <li>• Nematodes</li> <li>• Seedling blight pathogens</li> </ul>
	Plants cut off above or below ground	<ul style="list-style-type: none"> <li>• Cutworms</li> </ul>
	Sudden death of plants	<ul style="list-style-type: none"> <li>• Frost in low areas of field, leaves first appear water-soaked, then gray or whitish; if growing point of seedling is still underground or not affected and only top growth killed, plant should recover normally</li> <li>• Lightning—both corn and weeds killed, usually in a circular area with clearly defined margins; affected area does not increase in size</li> </ul>
Wilting	Upper leaves roll and appear dull or sometimes purple; stunting of plants plants may die	<ul style="list-style-type: none"> <li>• Drought conditions</li> <li>• Black cutworms—may chew a hole in the stalk below soil surface, which results in the plant wilting and dying</li> <li>• White grubs—chew off roots, no tunneling</li> <li>• Wireworms—may chew off or bore into roots</li> <li>• Corn root aphids—suck the juices from roots; always attended by brown ants</li> <li>• Mechanical pruning of roots by cultivator</li> <li>• Root and crown rot caused by pathogens</li> </ul>
	Whorl leaves dead	<ul style="list-style-type: none"> <li>• Wireworms</li> <li>• Cutworms</li> <li>• Stalk borer</li> <li>• Hop vine borer</li> <li>• Bacterial stalk rot</li> </ul>
	Crown roots not developing	<ul style="list-style-type: none"> <li>• Dry surface soil, shallow planting, wind</li> </ul>

General appearance	Specific symptoms	Possible causes
<b>Plants discolored</b>	Leaves appear sandblasted; leaves pale green or whitish in color	<ul style="list-style-type: none"> <li>• Wind damage—blowing sand and soil</li> <li>• Spider mites—feed primarily on underside of leaves; produce fine webbing across leaf surfaces; most destructive during hot, dry weather</li> </ul>
	Lower leaves with speckles or spots of dead tissue, new growth undamaged	<ul style="list-style-type: none"> <li>• Herbicide injury—postemergence contact herbicides, either photosynthetic inhibitors or membrane disrupters</li> </ul>
	General yellowing of upper leaves	<ul style="list-style-type: none"> <li>• Magnesium deficiency</li> </ul>
	General yellowing of lower leaves	<ul style="list-style-type: none"> <li>• Excessive moisture</li> </ul>
	Yellowing in the whorl, may present as yellow/translucent regions on these leaves after they emerge	<ul style="list-style-type: none"> <li>• Herbicide injury—from postemergence ALS-inhibitor herbicide or low dose of ACCase-inhibitor</li> </ul>
	Purpling or reddening of leaves from tip backward; affects lower leaves initially, leaf tips may later turn dark brown and die	<ul style="list-style-type: none"> <li>• Phosphorus deficiency—severe</li> <li>• Compacted soil</li> <li>• Cold weather</li> <li>• White grubs</li> <li>• Dinitroaniline herbicide injury—check for clipped root tips</li> </ul>
	Leaves of seedlings bleached white	<ul style="list-style-type: none"> <li>• Herbicide injury—Command carryover, Balance injury, low dose of Roundup Ultra</li> </ul>
	Irregular light and dark mottling or mosaic at base of whorl leaves	<ul style="list-style-type: none"> <li>• Maize dwarf mosaic or Maize chlorotic dwarf virus</li> </ul>
	Irregular light gray or silvery blotches on both sides of leaves on the east side of affected plants	<ul style="list-style-type: none"> <li>• ‘Sunscaud’—usually occurs when chilly, dewy nights are followed by sunny mornings</li> <li>• Frost</li> </ul>
	Light streaking of leaves which develops into a broadband of bleached tissue on each of the midribs; leaf midribs and margins remain green; sometimes stalks and leaf edges appear to be tinted red or brown	<ul style="list-style-type: none"> <li>• Zinc deficiency</li> </ul>
	Bright yellow to white stripes with smooth margins running the length of leaves; may appear on scattered plants throughout the field and sometimes only on one side of a plant	<ul style="list-style-type: none"> <li>• Genetic stripes</li> </ul>
	White or yellow stripes between leaf veins	<ul style="list-style-type: none"> <li>• Excessively acidic soil</li> <li>• Magnesium deficiency</li> <li>• Maize white line mosaic virus—if white lines are not continuous</li> </ul>
Distinct bleached bands across leaf blades; leaf tips may die back; leaf tissue may collapse at discolored bands, resulting in the leaf folding downward at this point	<ul style="list-style-type: none"> <li>• Air pollution injury</li> </ul>	



General appearance	Specific symptoms	Possible causes
<b>Plants discolored and stunted</b>	Leaves yellow; plants spindly and stunted	<ul style="list-style-type: none"> <li>• Nitrogen deficiency</li> <li>• Sulfur deficiency—more pronounced on younger leaves than nitrogen deficiency</li> </ul>
	Purple or red discoloration of leaves, especially leaf margins; stunting; stubby, malformed roots sometimes confused with injury by nematodes	<ul style="list-style-type: none"> <li>• Dinitroaniline herbicide injury — trifluralin(Treflan), pendimethalin (Prowl), Usually results from excessive rates, carryover from the previous year's application for soybeans or sunflower production or if pendimethalin applied to shallow planted corn; causes stubby roots with tips swelling and restricted secondary root development.</li> <li>• Phosphorus deficiency—mild</li> </ul>
<b>Plants discolored, malformed and/or stunted</b>	Excessive tillering; stunting	<ul style="list-style-type: none"> <li>• Crazy top—fungal disease</li> </ul>
	Slight yellow-green tint; severely stunted; inability of leaves to emerge or unfold— leaf tips stick together, giving plants a ladder-like appearance	<ul style="list-style-type: none"> <li>• Herbicide injury—Chloroacetamide herbicide (Lasso, Dual, Frontier, Surpass, Harness); Thiocarbamate herbicides (Eradicane)</li> </ul>
	Leaves yellow and not fully expanded; roots sheared off or dried up	<ul style="list-style-type: none"> <li>• Overapplication of anhydrous or aqua ammonia</li> </ul>
<b>Plants stunted and/or malformed</b>	Leaves fail to unfurl properly, often leafing out underground; plants may be bent, lying flat on the soil surface	<ul style="list-style-type: none"> <li>• Excessive Chloroacetamide herbicide rates— (Lasso, Dual, Frontier, Surpass, Harness)</li> </ul>
	Leaves stunted—twisted, and may appear knotted	<ul style="list-style-type: none"> <li>• Thiocarbamate herbicide injury— (Eradicane)</li> </ul>
	Shoots and roots stunted and/or onion-leafing (leaves remain wrapped in a tall spike)	<ul style="list-style-type: none"> <li>• Growth regulator herbicide (2,4-D, Banvel, Clarity) applied pre-emergence on coarse textured soil or to shallow planted corn, roots may also be short and thick</li> </ul>
	Plants bent or twisted	<ul style="list-style-type: none"> <li>• Growth regulator herbicide (2,4-D, Banvel, Clarity) applied post-emergence</li> </ul>
	Plants bent or twisted; stunted; irregular rows of holes in unfolded leaves	<ul style="list-style-type: none"> <li>• Stalk borer</li> <li>• Billbugs</li> </ul>
<b>Lesions on leaves</b>	Oval, circular or rectangular lesions on leaves	<ul style="list-style-type: none"> <li>• Northern corn leaf spot—</li> </ul>
	Long lesions (1-8 in.) that taper at ends	<ul style="list-style-type: none"> <li>• Northern corn leaf blight—</li> </ul>
	Long, irregular yellow to brown streaks in leaves	<ul style="list-style-type: none"> <li>• Stewart's bacterial leaf blight—</li> </ul>
	Tan to spindle-shaped lesions with parallel sides and buff to brown borders	<ul style="list-style-type: none"> <li>• Southern corn leaf blight—</li> </ul>
	Oblong, oval, tan-colored spots with considerable yellowing of leaves	<ul style="list-style-type: none"> <li>• Yellow leaf blight—</li> </ul>
	Brown, oval lesions; yellow to reddish-brown	<ul style="list-style-type: none"> <li>• Anthracnose leaf blight—</li> </ul>

General appearance	Specific symptoms	Possible causes
	Very small, yellow to brown spots in bands near leaf base	<ul style="list-style-type: none"> <li>• Physoderma brown spot—</li> </ul>
	Small (1-4 mm), translucent, circular to oval lesions	<ul style="list-style-type: none"> <li>• Eyespot—</li> </ul>
	Brown opaque, rectangular lesions (½-2 in.) between veins; lesions do not taper	<ul style="list-style-type: none"> <li>• Gray leaf spot</li> </ul>
	White dried areas between leaf veins	<ul style="list-style-type: none"> <li>• Air pollution injury</li> </ul>
	Dull, gray-green, water-soaked lesions that develop into white dry areas on leaf surfaces; oldest leaves may show the injury symptoms at their bases, next oldest leaves across their middles, and the youngest leaves at their tips; leaf margins most severely injured; midribs remain undamaged; NOTE: sweet corn is much more susceptible than field corn	<ul style="list-style-type: none"> <li>• Air pollution injury</li> </ul>
<b>Plant tissue removed</b>	Whole plant cut off at ground level	<ul style="list-style-type: none"> <li>• Back cutworm—</li> </ul>
	Leaves entirely eaten off or large chunks of leaf tissue removed	<ul style="list-style-type: none"> <li>• Armyworms—</li> <li>• Grasshoppers—</li> </ul>
	Ragged holes in leaves	<ul style="list-style-type: none"> <li>• Hail damage</li> <li>• Slugs—</li> <li>• European corn borers—</li> <li>• Black cutworms—early larval instar damage</li> </ul>
	Shredding, tearing of leaves	<ul style="list-style-type: none"> <li>• Wind damage</li> <li>• Hail damage</li> </ul>
	Rows of circular to elliptical holes across leaves	<ul style="list-style-type: none"> <li>• Billbugs—</li> <li>• European corn borers—</li> <li>• Stalk borers—</li> </ul>
	Irregular brown lines or 'tracks' scratched from the top layer of leaf tissue; heavily infested leaves may appear gray in color, shrivel and die	<ul style="list-style-type: none"> <li>• Corn flea beetles—</li> </ul>
	"Window effect" of leaves—interior of leaves (area between upper and lower surface) eaten out, leaving a transparent 'mine' with bits of dark fecal material scattered throughout	<ul style="list-style-type: none"> <li>• Corn blotch leaf miners—</li> </ul>

General appearance	Specific symptoms	Possible causes
	Yellowed and weakened area on leaf midrib from tunneling feeding damage; often frass (sawdust-like excrement) evident around the feeding wound; the midrib will commonly break at this point, causing the leaf blade to fold down from the damaged area	<ul style="list-style-type: none"> <li>• European corn borers—</li> </ul>

## Knee-high to Tasseling

General appearance	Specific symptoms	Possible causes
<b>Severe wilting and/or death of plants</b>	Sudden death of plants	<ul style="list-style-type: none"> <li>• Lightning—All plant material in an approximately circular area suddenly killed; plants along margin of affected area may be severely to slightly injured; severely injured plants may die later</li> </ul>
	Dieback of leaves, wilting, then drying up of leaf tissue, beginning at leaf tips	<ul style="list-style-type: none"> <li>• Molybdenum deficiency— younger leaves may twist</li> <li>• Air pollution injury</li> </ul>
<b>Plants discolored</b>	Yellowing of plants, beginning with lower leaves	<ul style="list-style-type: none"> <li>• Nitrogen deficiency—V-shaped yellowing of leaves, beginning at midrib and widening toward leaf tips; leaf tips die (“firing”) while leaf margins remain green</li> <li>• Drought conditions— produce nitrogen deficiency</li> <li>• Poned conditions—standing water can produce nitrogen deficiency</li> </ul>
	Yellowing of leaf margins, beginning at tips; affected tissue later turns brown and dies	<ul style="list-style-type: none"> <li>• Potassium deficiency</li> </ul>
	Purpling or reddening of leaves from tip backward; affects lower leaves initially; leaf tips may later turn dark brown and die	<ul style="list-style-type: none"> <li>• Phosphorus Deficiency</li> </ul>
	Yellow to white interveinal striping on leaves	<ul style="list-style-type: none"> <li>• Genetic stripe—stripes have smooth margins; may appear on scattered plants throughout the field and, sometimes, only one side of a plant</li> <li>• Magnesium deficiency—yellow to white striping usually developing on lower leaves; red-purple discoloration along edges and tip; stunting may occur</li> <li>• Boron deficiency—initially white, irregularly shaped spots develop between veins which may coalesce to form white stripes that appear waxy and raised from leaf surface; plants may be stunted</li> </ul>
	Pale green to white stripes between leaf veins, usually on upper leaves	<ul style="list-style-type: none"> <li>• Iron deficiency</li> </ul>

General appearance	Specific symptoms	Possible causes
	Upper leaves show pale green to yellow interveinal discoloration; lower leaves appear olive green and somewhat streaked; severe damage appears as elongated white streaks, the center of which turn brown and fall out	<ul style="list-style-type: none"> <li>• Magnesium deficiency</li> </ul>
<b>Plants discolored and malformed</b>	Plants show stunting and/or a mottle or fine chlorotic stripes in whorl leaves	Maize dwarf mosaic or Maize dwarf chlorotic
	Stunting, tillering; twisting and rolling of leaves;	Crazy top—fungal disease
<b>Plants malformed</b>	Plants “rat-tailed”—leaf edges of top leaf fused so leaves cannot emerge	<ul style="list-style-type: none"> <li>• Growth regulator herbicide (2,4-D, Banvel, Clarity) applied post-emergence with an ALS-inhibitor herbicide to seedling corn</li> <li>• Mechanical injury</li> </ul>
	Leaves tightly rolled and erect	<ul style="list-style-type: none"> <li>• Growth regulator herbicide (2,4-D, Banvel, Clarity) applied at high rates or excessive spray in the whorl after 8 inches tall</li> <li>• Drought stress</li> </ul>
	Plants lodge or grow up in a curved ‘sledrunner’ or ‘gooseneck’ shape	<ul style="list-style-type: none"> <li>• Corn rootworm larvae feeding damage -- damaged root systems result in entire plant becoming lodged; stalk breakage (lodging) does not result from rootworm damage</li> <li>• Nematode feeding damage—microscopic worm-like organism, several species which live in the soil and are parasitic on corn roots</li> <li>• Previous herbicide injury that had pruned root system—dinitroaniline or growth regulators</li> <li>• Mechanical injury</li> <li>• Hot, dry weather and winds—preventing normal brace root development</li> </ul>
	Brown, soft rot of a lower internode; stalks twist and fall	<ul style="list-style-type: none"> <li>• Pythium stalk rot or bacterial stalk rot</li> <li>• European corn borers—stalks weakened by borer feeding damage</li> <li>• Stalk borer</li> </ul>
	Fused braced roots	<ul style="list-style-type: none"> <li>• Growth regulator herbicide (2,4-D, Banvel, Clarity) applied after 8 inches tall</li> </ul>
	Soft, glistening white galls that soon become black and dusty; appears on stalks, leaves, ear or tassel	<ul style="list-style-type: none"> <li>• Common smut—</li> </ul>
<b>Plant tissue removed</b>	Ragged holes in the leaves, shredding of plants	<ul style="list-style-type: none"> <li>• Hail damage</li> </ul>
	Shredding, tearing of leaves	<ul style="list-style-type: none"> <li>• Wind damage</li> </ul>
	Green upper layer of tissue stripped from leaves	<ul style="list-style-type: none"> <li>• Western corn rootworm beetles—</li> </ul>

General appearance	Specific symptoms	Possible causes
	Window effect on leaves—interior of leaves (area between upper and lower leaf surfaces) eaten out, leaving a transparent 'mine' with bits of dark fecal material scattered throughout	<ul style="list-style-type: none"> <li>• Corn blotch leafminers—</li> </ul>
	Leaves entirely eaten off or large chunks of leaf tissue removed	<ul style="list-style-type: none"> <li>• Armyworms—</li> <li>• Grasshoppers—</li> <li>• Fall armyworm—</li> <li>• Livestock</li> </ul>
	Holes bored into stalks and area within stalk hollowed out by feeding damage	<ul style="list-style-type: none"> <li>• European corn borers—late instar damage</li> <li>• Stalk borers</li> </ul>
Lesions on plants	Oval, circular or rectangular lesions on leaves	<ul style="list-style-type: none"> <li>• Northern corn leaf spot—</li> </ul>
	Long lesions (1-8 in.) that taper at ends	<ul style="list-style-type: none"> <li>• Northern corn leaf blight—</li> </ul>
	Brown opaque, rectangular lesions (½-2 in.) between veins; lesions do not taper	<ul style="list-style-type: none"> <li>• Gray leaf spot</li> </ul>
	Tan, oval to circular lesions	<ul style="list-style-type: none"> <li>• Holcus bacterial spot</li> <li>• Fungal leaf spots</li> <li>• Paraquat herbicide injury</li> </ul>
	Irregularly or wavy-margined, pale green to yellow or pale brown streaks; in Corn Belt usually after tasseling	<ul style="list-style-type: none"> <li>• Stewart's bacterial leaf blight</li> </ul>
	Tan leaf lesions with parallel sides or spindle shaped with buff to brown borders in Corn Belt usually after tasseling	<ul style="list-style-type: none"> <li>• Southern corn leaf blight</li> </ul>
	Long, elliptical gray-green or tan lesions developing first on lower leaves; in Corn Belt usually after tasseling	<ul style="list-style-type: none"> <li>• Northern corn leaf blight</li> </ul>
	Very small, yellow to brown spots in bands near leaf base	<ul style="list-style-type: none"> <li>• Physoderma brown spot</li> </ul>
	Yellow mottling along leaf margins and tips; small irregular, yellow spots develop between veins and may form continuous yellow bands	<ul style="list-style-type: none"> <li>• Air pollution injury</li> </ul>
	Interveinal tan to yellow streaks on leaves	<ul style="list-style-type: none"> <li>• Air pollution injury</li> </ul>
	White dried areas between leaf veins; severe injury may cause tip dieback	<ul style="list-style-type: none"> <li>• Air pollution injury</li> </ul>
	Dull, gray-green, water-soaked lesions that develop into white dry areas on leaf surfaces; oldest leaves may show the injury symptoms at their bases, next oldest leaves across their middles, and the youngest leaves at their tips; leaf margins most severely injured; midribs remain undamaged; <i>NOTE: sweet corn is much more susceptible than field corn</i>	<ul style="list-style-type: none"> <li>• Air pollution injury</li> </ul>
	Brown, oval lesions with yellow to reddish-brown borders	<ul style="list-style-type: none"> <li>• Anthracnose leaf blight—</li> </ul>
Irregular to elliptical, brown, water-soaked leaf spots	<ul style="list-style-type: none"> <li>• Bacterial leaf spot and stripe</li> </ul>	



General appearance	Specific symptoms	Possible causes
	Small, circular tan spots with brown to purple margins	• Eyespot—
	Circular to oval, brown to black pustules on leaves	• Common corn rust

## Tasseling to Maturity

General appearance	Specific symptoms	Possible causes
<b>Silking impaired</b>	Delayed silking or failure to silk	<ul style="list-style-type: none"> <li>• Stress on plants earlier in the season</li> <li>• Plant population too high</li> <li>• Nutrient deficiency</li> <li>• Corn leaf aphids—typically found in large numbers feeding within the whorl</li> </ul>
	Silks clipped off	<ul style="list-style-type: none"> <li>• Corn rootworm beetles—two species attack corn: northern and western</li> <li>• Grasshoppers</li> </ul>
<b>Tassels malformed</b>	Tassels fail to emerge	• Boron deficiency
	Tassels, upper stalk and foliage bleached; premature drying	• Anthracnose
	Tassels develop as a mass of leaves	• Crazy top
<b>Ears replaced by leaves</b>	Leafy condition at ear node	• Crazy top
<b>Plants discolored</b>	Yellowing of leaf margins, beginning at tips; affected tissue later turns brown and dies	• Potassium deficiency
	Irregular, purple-brown spots or blotches on sheaths	• Purple sheath spot
<b>Stalks malformed and/or broken</b>	Lower stalk internodes easily compressed; stalks may lodge (break over); pith tissue destroyed	<ul style="list-style-type: none"> <li>• Diplodia stalk rot</li> <li>• Charcoal stalk rot</li> <li>• Gibberella stalk rot</li> <li>• Fusarium stalk rot</li> </ul>
	Lower internodes easily compressed; black linear streaks on stalk surface	• Anthracnose stalk rot
	Plants lodge, stalk may break	<ul style="list-style-type: none"> <li>• European corn borer</li> <li>• Potassium deficiency—yellowing of leaf margins, beginning at the tips; affected tissue later turns brown and dies</li> </ul>
<b>Premature death of all or some parts of plants</b>	Sudden death of entire plant	<ul style="list-style-type: none"> <li>• Stalk rot complex</li> <li>• Lightning—all plant material in an approximately circular area suddenly killed; plants along margins of affected area may be severely to slightly injured; severely injured plants may die later</li> <li>• Frost—before plants reach maturity—leaves first appear water-soaked, then gray; plants in low areas of fields most susceptible</li> </ul>

General appearance	Specific symptoms	Possible causes
	Extensive areas of leaf tissue die prematurely resulting in leaf drying	<ul style="list-style-type: none"> <li>• Air pollution injury</li> <li>• Stewart's Bacterial leaf blight</li> <li>• Northern corn leaf blight</li> <li>• Anthracnose leaf blight</li> </ul>
	Top kill—premature death of all or portion of plants above ears	<ul style="list-style-type: none"> <li>• Anthracnose</li> </ul>
<b>Leaf tissue removed</b>	Ragged holes in the leaves	<ul style="list-style-type: none"> <li>• Hail damage</li> </ul>
	Shredding, tearing of leaves	<ul style="list-style-type: none"> <li>• Wind damage</li> </ul>
	Small, irregular holes in leaves	<ul style="list-style-type: none"> <li>• European corn borer—second brood larval feeding</li> </ul>
	Large, irregular holes in leaves	<ul style="list-style-type: none"> <li>• Grasshoppers</li> <li>• Fall armyworms</li> </ul>
<b>Plants discolored or stunted</b>	Slight to severe stunting; yellowing and sometimes reddening of foliage	<ul style="list-style-type: none"> <li>• Maize dwarf mosaic/Maize chlorotic dwarf</li> </ul>
<b>Lesions on leaves</b>	Tan leaf lesions with parallel sides or spindle-shaped and buff to brown borders	<ul style="list-style-type: none"> <li>• Southern corn leaf blight</li> </ul>
	Long, elliptical, gray-green or tan lesions	<ul style="list-style-type: none"> <li>• Northern corn leaf blight</li> </ul>
	Small brown to red-brown spots to irregular blotches in bands	<ul style="list-style-type: none"> <li>• Physoderma brown spot</li> </ul>
	Small (1/16 to 3/8 inch) circular to oval lesions	<ul style="list-style-type: none"> <li>• Eyespot</li> </ul>
	Elongate, irregular brown water-soaked leaf stripes or spots on lower leaves	<ul style="list-style-type: none"> <li>• Bacterial leaf spots and stripe</li> </ul>
	Oval, circular or rectangular lesions on leaves	<ul style="list-style-type: none"> <li>• Northern corn leaf spot</li> </ul>
	White, dried areas between leaf veins	<ul style="list-style-type: none"> <li>• Air pollution injury— severe injury may cause premature maturity</li> </ul>
	Circular to oval lesions, brown centers with yellow to orange borders	<ul style="list-style-type: none"> <li>• Anthracnose leaf blight</li> </ul>
	Numerous brown to black pustules on any above ground part, especially the leaves; leaves dry out	<ul style="list-style-type: none"> <li>• Common corn rust</li> </ul>
<b>Damaged or malformed ears</b>	Dark 'bruises' on husks	<ul style="list-style-type: none"> <li>• Hail damage—all plant material in an area affected; often more severe on one side of plant</li> </ul>
	Pinched ears	<ul style="list-style-type: none"> <li>• ALS-inhibitor herbicide (Accent, Beacon, etc.) applied broadcast "over-the-top" after reaching the V6 stage</li> </ul>
	Ears with missing kernels	<ul style="list-style-type: none"> <li>• Growth regulator herbicide (2,4-D, Banvel, Clarity) applied at tasseling</li> </ul>
	Large chunks removed from husks and ears;	<ul style="list-style-type: none"> <li>• Grasshoppers</li> <li>• Birds—ears often upright, husks shredded</li> <li>• Rodents, raccoons, squirrels or other animals; stalks often pulled over, husks shredded or pushed back</li> </ul>
<b>Brown mold at base of ear</b>	White to pink mold starting at ear tip; husk rotted	Gibberella ear rot
	White to pink mold on individual kernels	<ul style="list-style-type: none"> <li>• Fusarium ear rot</li> <li>• Diplodia ear rot</li> </ul>

# Corn Scouting Calendar

Generalized Calendar for Corn Insect Pests of Wisconsin

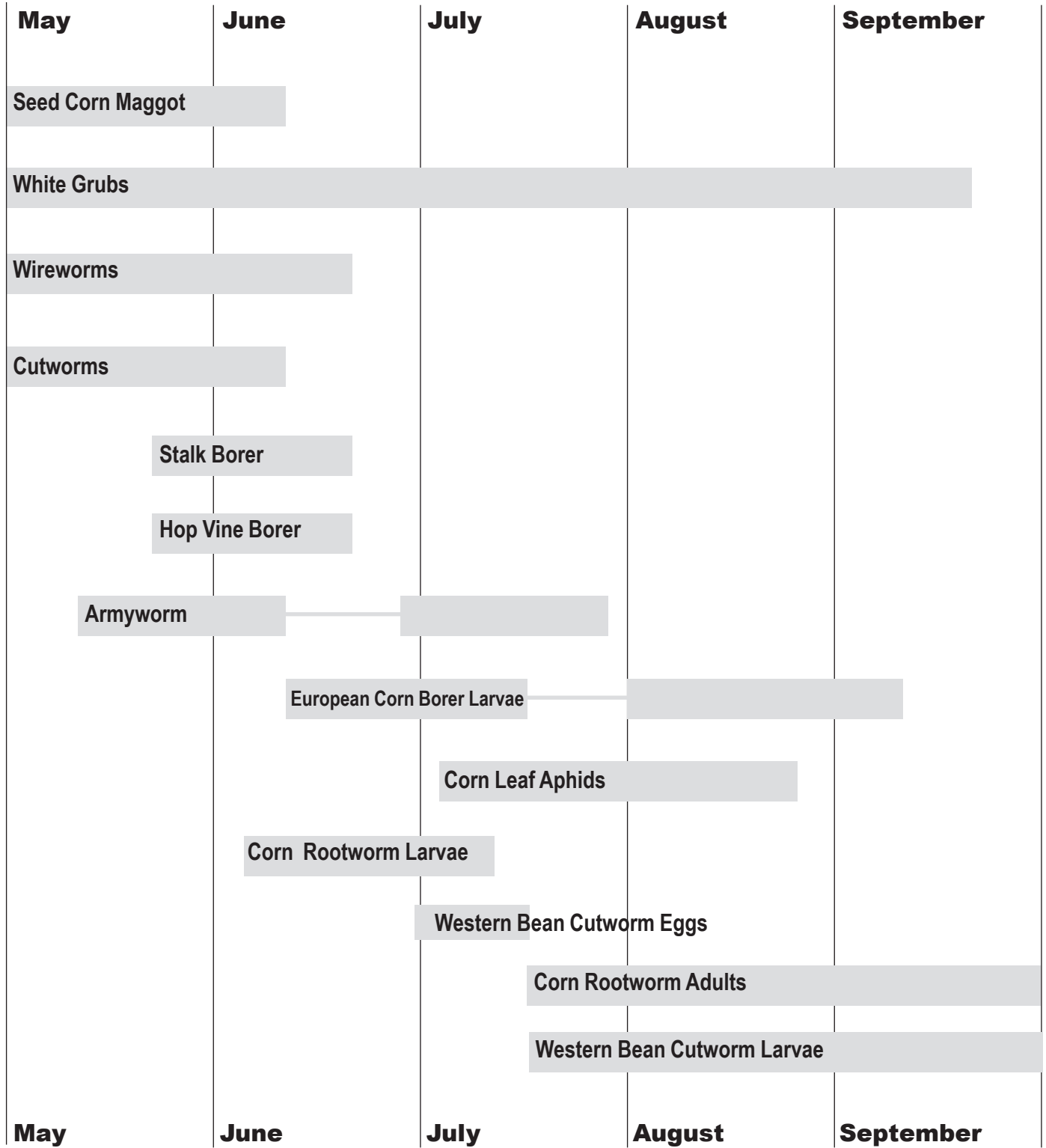

# Plant Physiology

## Critical Stages in the Life of a Corn Plant

by Heather Darby and Joe Lauer

Nature greatly influences corn growth and yield. However, the corn producer can manipulate the environment with managerial operations including hybrid selection, soil tillage, crop rotation, soil fertilization, irrigation, and pest control. A producer who understands growth and development of corn will understand the importance of timeliness when using production practices for higher yields and profit.

Our objective with this article is to aid those in corn production in understanding how a corn plant develops by explaining corn growth and development of stages critical for determining yield and identifying practices needed for optimum growth and production. A producer who understands the corn plant can use production practices more efficiently and timely to obtain higher yields and profits.

### Identifying Stages of Development

The staging system most commonly used is the Iowa System. It divides plant development into vegetative (V) and reproductive (R) stages.

Subdivisions of the V stages are designated numerically as V1, V2, V3, through Vn, where n represents the last stage before Vt (tasseling). The six subdivisions of the reproductive stages are designated numerically.

Each leaf stage is defined according to the uppermost leaf whose collar is visible.

Beginning at about V6, increasing stalk and nodal root growth combine to tear the small lowest leaves from



the plant. To determine the leaf stage after lower leaf loss, split the lower stalk lengthwise and inspect for internode elongation. The first node above the first elongated stalk internode generally is the fifth leaf node. The internode usually is about one centimeter in length. This fifth leaf node may be used as a replacement reference point for counting to the top leaf collar. In a corn field all plants will not be in the same stage at the same time. Each specific V or R stage is defined only when 50% or more of the plants in the field are in or beyond that stage.

VE Emergence	R1 Silking
V1 First leaf	R2 Blister
V2 Second leaf	R3 Milk
V3 Third leaf	R4 Dough
*	R5 Dent
*	R6 Physiological maturity
Vnth	
VT tasseling	

Although each stage of development is critical for proper corn production we will focus on VE, V6, V12, V18, R1, and R6. Yield components and the number of Growing Degree Units required at each growth stage are described below.

Stage	GDU	Potential Yield	Actual Yield
VE	125	ears/area	
V6	470	kernels rows/ear	"factory"
V12	815		kernels rows/ear
V18	1160	kernels/row	
R1	1250	kernel weight	kernel number, ears/area
R6	2350		kernel weight

---

## Stage VE Determination of potential ear density

- Approximately 7-10 days after planting (125 GDU)

### Aboveground

- Coleoptile tip emerges above soil surface (*Photo 1*)



- Elongation of coleoptile ceases
- 1<sup>st</sup> true leaves rupture from the coleoptile tip (*Photo 2*)



### Belowground

- Mesocotyl and coleoptile elongation
- Elongation of mesocotyl ceases when coleoptile emerges above soil surface
- Growing point is below the soil surface
- Completed growth of seminal root system (radicle + seminal roots)  
Seminal root system supplies water and nutrients to developing seedling
- Nodal roots are initiated  
Nodal roots are secondary roots that arise from belowground nodes.

### Troubleshooting

- Watch for seed attacking insects: (see chart on page 9)
- Germination and emergence delayed when:
  - Inadequate moisture
  - Cool soil temperatures (<50°F)
- Planting depth around 1.5-2.0"
  - 1<sup>st</sup> leaves will emerge belowground if seed planted too deep, or soil is cloddy or crusted
- Herbicide injury: coleoptiles will be corkscrew shaped, and have swollen mesocotyls
- Frost will not affect yield (<28 F)
- Hail will not affect yield (max)



- Severe yield losses from flooding (>48 h)

### Management Guide

- Banding small amounts of starter fertilizer to the side and slightly below the seed can improve early vigor, especially when soils are cool.
- If conservation tillage is implemented add 30-60 GDU to VE
- If planting date is <April 25 add 10-25 GDU to VE
- If planting date is >May 15 subtract 50-70 GDU to VE
- Seeding depth: add 15 GDU for each inch below 2 inches to VE
- Seed-bed condition: soil crusting or massive clods add 30 GDU to VE
- Seed-zone soil moisture: below optimum, add 30 GDU to VE

---

### Stage V6 Potential plant parts (“factory”) developed

- 24-30 days after emergence (475 GDU)

#### Aboveground

- All plant parts are present
- Growing point and tassel (differentiated in V5) are above the soil surface (*Photo 3*)

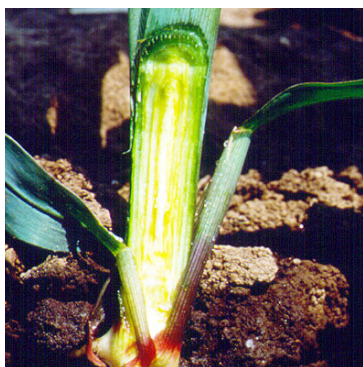

- Stalk is beginning a period of rapid elongation
- Determination of kernel rows per ear begins  
Strongly influenced by hybrid genetics
- Tillers (suckers) begin to emerge at this time
- Degeneration and loss of lower leaves
- New leaf emerging (V-stage) about every 3 days

#### Belowground

- Nodal root system is established (approx. 18” deep X 15” wide) (*Photo 4*)



This is now the main functional root system of the plant

## Troubleshooting:

- Lodged plants  
Rootworm eggs will soon hatch and larvae begin feeding on root systems
- Foliar defoliation from hail, wind, and leaf feeding corn borers  
May decrease row number
- 100% yield loss to frost caused from plant death
- 53% yield loss to hail when completely defoliated
- Severe yield loss to flooding

## Management Guide

- Time to apply nitrogen (up to V8) before rapid uptake period in corn  
Precise fertilizer placement is less critical

---

## Stage V12 Potential kernel rows determined

- 42-46 days after emergence (815 GDU)

### Aboveground

- Number of kernel rows is set
- Number of ovules (potential kernels) on each ear and size of ear is being determined  
Strongly affected by environmental stresses
- New V-stage approximately every 2 days

### Belowground

- Brace root formation begins stabilizing the upper part of the plant.

## Troubleshooting

- Moisture Deficiencies will reduce potential number of kernels and ear size  
Plant is utilizing 0.25 inches per day.  
Water use rates for corn shown below.

Water Use Rate (inches/day)	Growth Stage
0.25	12 leaf
0.28	early tassel
0.30	silking
0.26	blister kernel
0.24	milk
0.20	dent
0.18	full dent

- Nutrient Deficiencies, will reduce potential number of kernels and ear size  
Large amounts of nitrogen, phosphorous, and potassium are being utilized at this stage
- 100% yield loss to frost caused from plant death
- 81% yield loss to hail when completely defoliated
- 3%/day yield loss to drought or heat (leaf rolling by mid-morning)
- Flooding (<48 h) will not affect yield

## Management Guide

- Potential kernel number and ear size is also related to the length of time available for their determination. Early hybrids- progress faster through growth stages and usually have smaller ears than late hybrids.

---

### Stage V18 Potential kernels per row determined

- 56 days after emergence (1160 GDU)

#### Aboveground

- Ear development is rapid
- The upper ear shoot is developing faster than other shoots on the stalk

#### Belowground

- Brace roots are now growing from nodes above the soil surface. They will scavenge the upper soil layers for water and nutrients during reproductive stages. (*Photo 5*)



#### Troubleshooting

- Moisture deficiency will cause lag between pollen shed and beginning silk (“nick”) Largest yield reductions will result from this stress Plant using 0.30 inches per day
- Lodging will cause 12-31% yield reduction
- 100% yield loss to frost (<28 F) caused from plant death
- 100% yield loss to hail (max) when completely defoliated
- 4% yield loss per day due to drought or heat when leaf rolling by mid-morning
- Flooding (<48 h) will not affect yield

## Management Guide

- Nitrogen applied through irrigation water, should be applied by V18

---

### Stage R1 Kkernel number and potential kernel size determined

- 69-75 days after emergence (1250 GDU)

## Aboveground

- ▶ Begins when any silks are visible outside the husks (*Photo 6*)



- ▶ Pollen shed begins and lasts 5-8 days per individual plant (*Photo 7*)



- ▶ Silk emergence takes 5 days
  - Silks elongate from base of ear to tip of ear
  - Silks elongate until pollinated
- ▶ Silks outside husks turn brown
- ▶ The plant has now reached its maximum height
- ▶ First 7-10 days after fertilization cell division occurs within kernel
- ▶ Remaining R stages, endosperm cells fill with starch

## Belowground

- ▶ The plant must have a healthy root system because proper uptake of moisture and nutrients are critical at this time

## Troubleshooting

- ▶ Hot and Dry weather results in poor pollination and seed set
  - Dehydrates silks (delay silking) and hastens pollen shed
  - Causes plants to miss window for pollination
  - Decreases yield 7% per day (leaf rolling by mid-morning)
- ▶ Moisture deficiencies at this time will reduce yields 7% per day
- ▶ Rootworm beetle clips silks which prevents pollination if less than a 1/2" of silk is showing
- ▶ 100% yield loss to frost (<28 F) caused from plant death
- ▶ 100% yield loss to hail when completely defoliated
- ▶ Flooding (<48h) will not affect yield at this stage

## Management guide

- Rootworm beetle control should be implemented if 4-5 beetles are observed feeding near ear tip.
- Stresses that reduce pollination result in a “nubbin” (an ear with a barren tip)

---

## Stage R6 Actual kernel weight determined

- 130 days after emergence or 50-60 days after silking (2350 GDU)

### Aboveground

- Physiological maturity is reached when all kernels on the ear have attained their dry matter maximum accumulation
- The hard starch layer has advanced completely to the cob  
Goes from top of kernel to base of cob
- A black abscission layer has formed  
This indicates that moisture and nutrient transport from the plant has ceased (Photo 8)



- Kernels are at 30-35% moisture and have attained 100% of dry weight (Photo 9)



### Management Guide

- Grain is not ready for safe storage  
Needs to be at 13-15% moisture for long-term storage  
May be advantageous to let crop partially dry in the field
- Silage harvest would be slightly earlier than R6 as milkline moves down towards kernel tip
- Frost has no effect on yield at this point. However, lodging from disease, insect damage or can result in physical loss of yield.



# Conclusion

For most of Wisconsin hybrids (~100 day), each plant typically develops 20-21 leaves, silks about 65 days after emergence, and matures about 120 days after emergence. All normal plants follow this same general pattern of development, but specific time intervals between stages and total leaf numbers developed may vary between different hybrids, seasons, planting dates and locations. The rate of plant development for any hybrid is directly related to temperature, so the length of time between the different stages will vary as the temperature varies. Environmental stress may lengthen or shorten the time between vegetative and reproductive stages.

The length of time required for the yield components of ear density, kernel number, kernel weight varies between hybrids and environmental conditions.

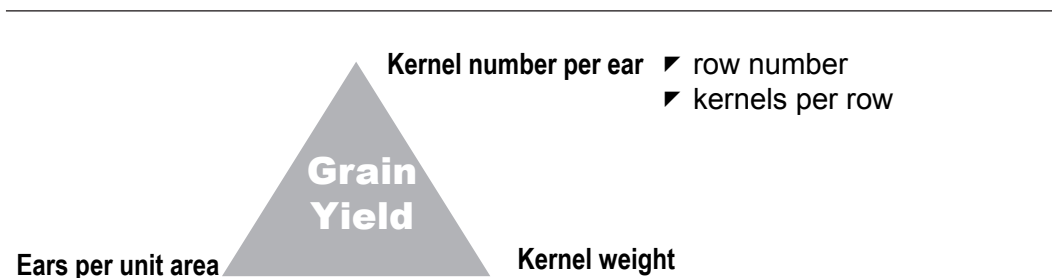

Ears per unit area, kernel number per ear and kernel weight all contribute to yield. These yield components of corn are determined early in the life cycle of the corn plant. It is true that yield is the end product but the plant must go through a number of stages to produce yield. Understanding this process won't necessarily put "money in your pocket", but by knowing when yield components are determined helps to interpret management and environmental factors influencing yield.

# Quick Reference Photos

## Field Corn Insects



Armyworm



Black Cutworm



Corn Leaf Aphid



Corn Rootworm  
Larvae



Corn Rootworm Adult  
(Northern)



Corn Rootworm Adult  
(Western)



European Corn Borer  
Eggs/Larvae/Adult



Hop Vine Borer



Potato Stem Borer

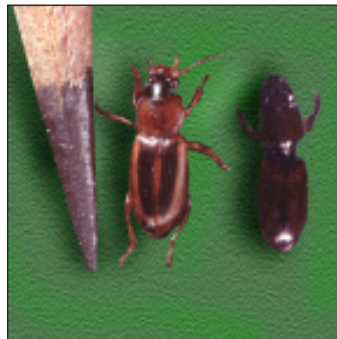

Seed Corn Beetles  
Striated/Smooth



Seed Corn Maggot  
All Stages



Stalk Borer



Western Bean Cutworm  
larvae

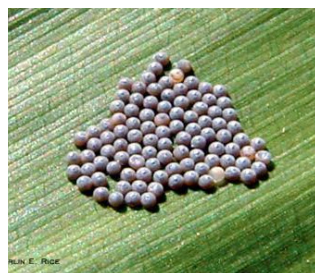

Western Bean Cutworm  
eggs



White Grub



Wireworm

# Insect Profiles

---

## Armyworm



Scientific Name: *Pseudaletia unipunctata*

Order: Lepidoptera

Family: Noctuidae

### Biological Description:

The armyworm can be a serious pest on field corn. Outbreaks are more severe following cold, wet, spring weather. The sand colored moths have a wing span of 1.5" with a definitive white dot in the center of each forewing and dark markings on the hind wings. The brownish green larvae are hairless, have alternate dark and light stripes down their backs and are about 2" long when fully grown. The head is pale brown with dark markings. Pupae are dark brown and approximately 3/4 inch in length. They are sharply tapered at the tail end with a much more rounded head end. The greenish white eggs are laid in rows or clusters on leaves. Moths often seem to congregate in certain locations. Armyworms often are confused with the variegated cutworm and other related species.

### Economic Importance:

Damage is sporadic and dependent on heavy flights of southern moths reaching Wisconsin. Armyworms may be a problem in corn no-tilled into alfalfa or grass sod or in fields with heavy weed pressure.

### Life Cycle:

Armyworms do not overwinter in Wisconsin. The moths usually migrate to Wisconsin. Once they arrive, they immediately mate. Eggs are laid in the evening and at night and eggs are laid in rows or clumps of many eggs. Grasses and small grains are the preferred host and blades are often folded and sealed to protect the eggs. One week to 10 days after the eggs are laid, the larvae emerge and begin to feed. After feeding for 3-4 weeks, the full-grown larvae pupate for an additional 2 weeks and emerge as adults. There are 2-3 generations per season, with each generation lasting 5-6 weeks. The first generation is usually small but is capable of cause economic damage to wheat and corn planted after grass cover crops and/or when grassy weeds are not controlled. The success of this generation produces later, more injurious, generations of armyworms. The second larval generation, which appears in July, is the largest and most damaging generation to Wisconsin crops. The fall generation is typically not injurious and is often heavily parasitized by beneficial insects, fungi and viruses.

## Host Range:

Armyworms attack all grasses, particularly wheat, oats, corn barley and rye and some legumes; but when under stress armyworms will attack neighboring vegetable crops and seedling alfalfa. Additionally, the presence of grass weeds in fields will attract moths for egg laying.

## Damage/Symptoms:

Larvae tend to feed at night or on cloudy days and hide in the soil or under foliage during the day. First generation damage can be very difficult to locate and will catch many scouts by surprise. Pay close attention to corn planted after grass cover crops and/or corn fields which have high grassy weed populations. In Wheat and other small grains detection is also difficult. Pay special attention to areas where crop density is high and/or where lodging has occurred. Second generation infestations may occur throughout a corn field during July if grassy weeds such as foxtail, quackgrass, goosegrass, and nutsedge are present for oviposition in the field. In this case, plants in scattered areas of the field will have ragged leaves from larval feeding. The other type of infestation results when armyworms migrate from pastures, oats, or grassy pea or alfalfa fields, to destroy the outside rows of corn. Damage is usually highest along the field edge or in grassy spots.

## Scouting Procedure and ET:

Timely detection is critical if post emergent insecticidal treatment is to be effective. If you find signs of armyworm feeding, check 5 sets of 20 plants at random. Record the number of damaged plants and the number of worms per plant. Repeat in several locations within the field since infestations may be restricted to certain areas. Treatment is suggested if worms are  $\frac{3}{4}$  inch long or less, and two or more worms per plant can be found on 25% of the stand; or if one worm per plant can be found on 75% of the stand. Spot treat when possible. When armyworms migrate from adjoining areas, treat only border rows.

## Non-Chemical Control:

**Natural Control:** A number of braconid wasps and tachinid flies help keep armyworm numbers down, as do birds, toads, skunks and some domestic fowl.

**Cultural Control:** Since female moths prefer to lay eggs in grassy areas, keeping grassy weeds controlled will lessen the possibility of problems. Avoid planting susceptible crops in low wet areas or in rotations following sod. If this is unavoidable, be sure to plow in the fall of the previous season to decrease early spring egg-laying sites. Killing grass with a herbicide or tillage may drive armyworms to the susceptible crops.

**Biological Control:** Several natural enemies exist which may keep armyworm populations low. The red-tailed tachinid fly (*Winthemia quadripustulata*) is one such biocontrol agent. It lays its eggs on the armyworm's back and the tachinid larvae bore into larval armyworms to feed. In addition, several ground beetles and parasitic hymenoptera prey upon the armyworm. There is also an egg parasite (*Telenomus minimus*) that is effective in preventing egg hatch and subsequent larval feeding damage.

## Chemical Control:

Consult UW Extension Bulletin "Pest Management of Wisconsin Field Crops" A3646 for control recommendations. This bulletin may be purchased from your local county extension office or is available to view, purchase or download from UW Cooperative Extension's The Learning Store at <http://learningstore.uwex.edu/>

Insecticide Resistance: None.



## References:

- R. H. Davidson and W. F. Lyon (1987) *Insect Pests 8th Ed. of Farm, Garden, and Home*. John Wiley & Sons, New York 640 pp.
- C. L. Metcalf and R L. Metcalf (1993) *Destructive and Useful Insects, Their Habits and Control 5th Ed.* McGraw Hill Book Co., New York.

---

# Black Cutworm



Scientific Name: *Agrotis ipsilon*  
Order: Lepidoptera  
Family: Noctuidae

## Biological Description:

Black cutworm larvae generally feed at, or below the ground surface at night. It is an active feeder on young foliage or stem tissue and will cut off many young seedlings in an evening. The large, greasy, dark gray larvae will curl up into a tight c shape if disturbed. Mature larvae are 1.5" long and have a grainy texture. Adult cutworms are gray moths which have a series of distinctive dark markings on their forewings and lighter colored hind wings. The black cutworm larvae are easily confused with other cutworms, but generally damage crops earlier in the season than other species. This cutworm is particularly problematic to the home gardener.

## Economic Importance:

Damage is not common on field corn but heavy infestation can occur. Early season scouting is recommended. Consult county and state newsletters for moth flight records.

## Life Cycle:

Moths that appear in Wisconsin migrate from other states. Overwintering black cutworms in Wisconsin are rarely abundant enough to cause significant damage. Female moths lay hundreds of eggs either singly or in clusters. Oviposition is typically concentrated on low-growing vegetation such as chickweed, curly dock, mustards or plant residue from the previous year's crop. Corn planted after soybeans is often a preferred oviposition site. As a result, heavy spring weed growth, newly broken sod, previous crop and plant debris all increase the risk of black cutworm infestations. Late-planted cornfields are most heavily damaged during an outbreak of black cutworms. Generally, black cutworm moths will not lay eggs in fields that have already been planted.

Young larvae (less than one-half inch in length) feed above ground on corn foliage. Larger larvae feed on the stalk at, or just below the soil surface. Although in fields with very dry soil conditions the larvae

may be found 2-3 inches deep. "Cutting stage larvae" may take as long as 34 days to pupate at temperatures of 60°F, while only 12 days may be required at temperatures of 75°F. There are three generations per year. It is the first generation which is active during May and June that causes the most damage to field corn.

**Host Range:**

Black cutworm larvae attack a wide variety of vegetable and field crops, especially in the seedling stage.

**Environmental Factors:**

Excessive rainfall may disrupt egg-laying. Flooding may force larvae to the soil surface during the day where they are attacked by parasites or predators.

**Damage/Symptoms:**

Newly hatched larvae are unable to chew entirely through the leaf surface resulting in a "window pane" appearance on the leaves. As the larvae grow, their feeding damage appears as small pinholes in the leaves and often complete defoliation of the leaves is possible. Once the larvae reach the "cutting" stage, they are 1/2 inch long and cut the stem at, or just below the soil surface. This type of injury is common during extended periods of dry weather. In later crop stages (V3-V4) large larvae may not be able to cut plants. Instead, larvae will burrow into the corn plant, below ground level, and result in symptoms often described as "wilted whorl" or "dead heart". In these situations the newly emerging whorl leaves wilt. Older leaves may remain green for a period of time.

<b>Guide to Black Cutworm Development and Damage to Corn</b>				
Larval Instar	Approximate days left to feed	Potential number of plants that may be cut		
		1 leaf	2 leaf	4 leaf
4	25	4	3	1
5	21	4	3	1
6	14	4	3	1
7	5	1	1	1

**Scouting Procedure and ET:**

Timely detection is critical if post emergence insecticidal treatment is to be effective and economical. Concerns over damage are greatest during the first ten days to two weeks after corn emergence. Examine a minimum of 250 plants (50 plants in each of 5 locations) in a field. When damaged plants are found, dig around the base of the plant for live cutworms. Collect at least 10 larvae and determine their age by using the head capsule gauge found in the bulletin titled "Field Crop Insect Stages" which can be found later in this chapter.

Consider treating when approximately 5% of the plants show damage AND cutworm larvae are sixth instar or smaller. For help in determining the damage potential of various cutworm instars, consult the table at the bottom of page.



## Non-Chemical Control:

**Natural Control:** A number of braconid parasites and predaceous ground beetles help keep cutworm numbers down. Cutworms are most problematic in low, wet, grassy areas. Cutworms serve as prey to birds.

**Cultural Control:** Since female moths prefer to lay eggs in weedy situations, keeping weeds controlled will lessen the possibility of damage. Avoid planting susceptible crops in low wet areas or in rotations following sod.

**Biological Control:** Several species of tachinids, braconids and ichneumonids help reduce populations.

## Chemical Control:

Consult UW Extension Bulletin "Pest Management in Wisconsin Field Crops" A3646 for control recommendations. This bulletin may be purchased from your local county extension office or is available to view, purchase or download from UW Cooperative Extension's The Learning Store at

<http://learningstore.uwex.edu/>

Insecticide Resistance: None.

## References:

R. H. Davidson and W. F. Lyon (1987) *Insect Pests 8th Ed. of Farm, Garden, and Home*. John Wiley & Sons, New York 640 pp.

---

# Corn Leaf Aphid



Scientific Name: *Rhopalosiphum maidis*

Order: Homoptera

Family: Aphididae

## Biological Description:

The corn leaf aphid is a small, bluish-green to gray, soft-bodied insect about the size of a pinhead. They may be winged or wingless. One unique characteristic of aphids is the ability of the adult females to give birth to live young as opposed to laying eggs like other insects. Both the immature nymphs and adults appear similar and it is often difficult to distinguish between the two.

## Economic Importance:

The corn leaf aphid may occasionally be a problem in field corn grown in the Midwest.

## **Life Cycle:**

Corn leaf aphids appear in the upper Midwest in mid-summer as winged forms migrate from the south. There may be as many as nine generations per year. Winged and wingless adults as well as nymphs may be found on the same plant at the same time. As the aphids grow, they shed their skins. In heavy infestations, plants may take on a grayish cast as these skins begin to accumulate. Because the aphid's diet is high in sugars, the honey dew excreted by the aphid as waste serves as an excellent medium for the growth of molds. These molds may give the plant a black appearance but are not considered plant pathogenic.

## **Host Range:**

The corn leaf aphid may be found on all varieties of corn, small grains as well as many other wild and cultivated plants in the grass family.

## **Environmental Factors:**

Heavy rain can rapidly decrease aphid populations as well as produce ideal conditions for the rapid spread of several fungal diseases.

## **Damage/Symptoms:**

Like other aphids, the corn leaf aphid possesses fine, needle-like, piercing mouthparts, which are inserted between plant cells and into the vascular tissue. Typically, this causes little direct morphological damage. Under heavy infestations, leaves may curl, wilt and become chlorotic. Plants may become sticky with honeydew or blackened with sooty mold, a fungus which grows saprophytically on the honey dew. Occasionally, heavily infested plants may be barren if aphid feeding on the tassel or silk interferes with pollination. Corn leaf aphids may be vectors for some corn diseases.

## **Scouting Procedure and ET:**

Corn leaf aphids can be found in the curl of the leaves, deep within the whorl, the upper part of the corn stalk, the unemerged tassel as well as the emerged tassel. Examine 10 sets of five consecutive plants (50 plants) for corn leaf aphids during the late whorl to early tassel emergence stages. You will, of course, have to pull the whorl leaves, unroll them, and search for the aphids. Make note of any natural predators and numbers present. If 50% of the plants have 50 or more aphid, make a single insecticide application when plants are in the late whorl to early tassel stage of development.

## **Non-Chemical Control:**

**Natural Control:** Several parasites, predators, and pathogens are effective in keeping aphid populations below economically damaging levels. When scouting, look for lady beetle adults and larvae, lacewing larvae and syrphid fly maggots. Aphid colonies with brown or golden aphids are diseased or parasitized.

**Cultural Control:** Damage by the aphids may be avoided by planting early in the season. Proper tillage and fertilization which hastens plant growth is also recommended.

**Biological Control:** None.

## **Chemical Control:**

Consult UW Extension Bulletin "Pest Management of Wisconsin Field Crops" A3646 for control recommendations. This bulletin may be purchased from your local county extension office or is available to view, purchase or download from UW Cooperative Extension's The Learning Store at

<http://learningstore.uwex.edu/>

Insecticide Resistance: None.

## References:

C. L. Metcalf and R. L. Metcalf (1993) Destructive and Useful Insects, their Habits and Control 5th Ed. McGraw Hill Book Co., New York.

---

# Corn Rootworm



Scientific Name: *Diabrotica barberi*, *Diabrotica virgifera virgifera*

Order: Coleoptera

Common Names: Northern Corn Rootworm, Western Corn Rootworm

## Biological Description:

Fully grown larvae of northern and western corn root worms are approximately 1/2 inch long and the diameter of a medium pencil lead. Their heads are brown to black and there is a dark plate on the dorsal side of the last abdominal segment. Northern corn rootworm beetles are approximately 1/4 inch long and pale yellow to tan in color when they first emerge from the soil. As adults mature, they become light green. The western corn rootworm adult is also 1/4 inch long but is characterized by the alternating yellow and black stripes along the back of the female. The male is also yellow and black but the wing covers are more uniformly black and lack the striping present on females.

## Economic Importance:

Northern and western corn rootworms are two of the most destructive insect pests of corn in the southern two-thirds of Wisconsin. Damage results from both root feeding by the larvae and silk clipping by the adults. In addition, the western corn rootworm also feeds on the leaves, however, leaf feeding is not an economic concern.

## Life Cycle:

Both species of corn rootworm beetles overwinter as eggs in the upper soil layers. In the spring, eggs complete development and larvae emerge and begin feeding on corn roots. The first instar larvae begins feeding on the smaller branching corn roots. Later, the rootworms migrate toward roots at the base of the plant. Larvae may be present throughout the summer but commonly, larval damage peaks in mid-July. After three weeks, three larval instars have been completed and the larvae enter the pupal stage. Pupae are white and resemble the beetle. Typically they are found near the plant base but pupae have been recovered over 2 feet away. After a day or two the adult beetles emerge. Adult corn rootworm beetles are pollen feeders and are often found on ornamental flowers as well as vegetables.

A three year study at the UW Arlington Research Station revealed that adults typically appear between July 16-24, however, in recent years adults have been found in early July. The western corn rootworm adults appear slightly before those of the northern corn rootworm and the western corn rootworm male beetles begin to emerge before the females. Females begin laying eggs approximately two weeks after mating. In Wisconsin, this starts in early to mid-August and continues well into September. While the reproductive potential of each female beetle is 1000 eggs, 300-500 eggs are more common. The eggs enter diapause, a resting state in which they will overwinter. Development and maturation occurs in the spring. There is one generation per year.

### **Host Range:**

Sweet corn, field corn and some prairie grasses.

### **Environmental Factors:**

Soil moisture influences both the number of eggs laid as well as the location of oviposition. Corn rootworm beetles lay more eggs in moist soil than dry soil. The higher the soil moisture, the closer to the surface the eggs are laid. Low soil temperatures in the winter as a result of little snow cover may contribute to high egg mortality of the western corn rootworm.

### **Damage/Symptoms:**

Rootworms cause damage by tunneling in corn roots. Evidence of corn rootworm activity consists of brown, elongated scars on the root surface, tunnels within the roots and varying degrees of root pruning. Lodging of plants caused by root pruning is common after storms containing heavy rains and high winds. Slight to moderate lodging can result in reduced ear weight and a goose-necked appearance in the plants. Adult corn rootworm beetles also feed on green corn silks, thereby reducing pollination. This often results in poor ear fill. The western corn rootworm also feeds upon corn leaves. Late planted corn is more susceptible to adult leaf feeding injury (western) and silk pruning by both species because beetles are attracted to fresh pollen and silk. These late-planted fields will attract beetles from surrounding, more advanced fields.

### **Scouting Procedure and ET:**

Because corn rootworm beetles can reduce yield by silk pruning, it is important to scout corn fields during pollination. Growers should begin checking for adults beetles before 70% of the plants are in the process of silking. Count the number of beetles on 10 random plants in five separate areas for a total of 50 plants. Record the number of beetles per plant and the number of plants with silks clipped to 1/4 inch or less. In addition, record the number of plants that haven't begun to silk, the number with fresh silk and the number with brown silk.

In addition to determining the potential for corn rootworm damage in the current year, scouting will also provide insight into the potential for damage if corn is planted the following year. For continuous corn (corn after corn), scout corn acreage three times at 7-10 day intervals from early August through early September. Count the number of western and northern corn rootworm beetles on 50 plants each time you sample. Examine 5 plants at each of ten areas in the field. Count the beetles on the entire plant. First, grasp the ear tip tightly enclosing the silks in the palm of your hand and count all other areas of the plant first. Pull leaves away from the stalk to examine leaf axils and expose hiding beetles. The silks often have the most beetles on the plant, so a tight hold on the ear tip keeps beetles from dropping out. Open your hand slowly and count the beetles that come out of the silks as you strip the husk away from the ear tip. By determining the level of adult infestation this year, you may be able to determine whether preventative corn rootworm insecticide treatments will be necessary the following year. The grower will need to use a soil insecticide, or rotate to a crop other than corn, if you find an average of 0.75 beetles per plant during any of the three field samplings.

In limited areas of south/southeastern Wisconsin, western corn rootworm females may lay enough eggs in soybeans to cause significant economic damage to first year corn planted after soybean. To avoid unnecessary insecticide applications in first year corn, it would be advisable to monitor western corn rootworm populations where there is a potential for damage. The Pherocon AM unbaited yellow sticky trap is the most reliable method to monitor western corn rootworm populations in soybean and to predict damage potential in first year corn. These traps are a visual attractant. No lure is needed.

Evenly distribute 12 traps/soybean field beginning in early August. Traps should be placed a minimum of 100 feet from the field edge and 100 paces between traps. Place traps on a stake above the soybean canopy. Count beetles and replace traps (if needed) on a weekly schedule.

Trapping can conclude the first full week in September when egg laying is complete. A management technique (crop rotation or insecticide) should be used if an average of 5-10 western corn rootworm beetles are caught/trap/day. For example, if you counted a total of 1680 WCR beetles in twelve traps over a 28 day period this would equal an average of 5 beetles/trap/day {1680 divided by 12(#traps/field) divided by 28 (# days you trapped) = 5}.

Research conducted by entomologists at the University of Illinois, suggest an average of 5 beetles/trap/day would likely result in a corn root rating of 0.25 on the Iowa State node-injury scale. An average of 10 beetles/trap/day would result in a root rating of 1.00. Root feeding damage by corn rootworms can be difficult to interpret into yield loss. A corn root rating less than 0.25 is not expected to suffer yield loss greater than the cost of an insecticide application. A corn root rating greater than 1.00 would be expected to suffer significant economic loss. Roots that rate between 0.25 and 1.00 are considered to be in a gray area and economic loss could be dependent on other crop growth factors (weather, size of root mass, fertility, etc.).

### **Non-Chemical Control:**

**Natural Control:** While adult and larval corn rootworms are essentially free of parasites, ground beetles and predacious mites may control rootworm populations by feeding on eggs, larvae and pupae.

**Cultural Control:** Crop rotation has been an excellent method of controlling corn rootworm damage. However, since 2002, western corn rootworm damage to corn after soybeans has been documented in areas of southern and southeastern Wisconsin. This damage is the result of female western corn rootworm laying eggs in soybean fields and has limited the effectiveness of crop rotation within this region. However, it must be noted that the majority of Wisconsin can effectively use crop rotation to control western corn rootworm damage.

The northern corn rootworm has a different method of circumventing crop rotation. Extended egg diapause, although not been observed in Wisconsin, has been documented in Minnesota, Iowa and South Dakota. Typically, rootworm eggs must go through one winter chill period before hatching. Northern corn rootworm eggs with the extended diapause trait must go through two winter chill periods before hatching. Thereby limiting the effectiveness of a corn/soybean rotation in these regions of the corn belt.

**Biological Control:** None.

### **Chemical Control:**

Consult UW Extension Bulletin "Pest Management of Wisconsin Field Crops" A3646 for control recommendations. This bulletin maybe purchased from your local county extension office or is available to view, purchase or download from UW Cooperative Extension's The Learning Store at <http://learningstore.uwex.edu/>

**Insecticide Resistance:** Resistance has developed to carbaryl and methyl parathion in areas of Nebraska where there has been a history of adult control.



---

# European Corn Borer



Scientific Name: *Ostrinia nubilalis*  
Order: Lepidoptera  
Family: Pyralidae

## Biological Description:

Eggs are white, overlapped like fish scales, and are deposited on the lower leaf surface of corn leaves and near the midvein. If ears are present, moths will also lay eggs on the flag leaves at the tip of the ear. There can be as many as 30-40 eggs in each mass. As they develop, the eggs change to a creamy color. Just before hatching, the black heads of the larvae become visible inside each egg. This is referred to as the black-head stage and each egg reaching this stage usually hatches within 24 hours. Full grown larvae are  $\frac{3}{4}$  - 1 inch in length and grey to cream-colored with numerous dark spots covering the body. The pupae are brown,  $\frac{3}{4}$  inch long and cigar shaped with segmentation evident on one-half of the body. The adults are nocturnal, straw-colored moths with a 1 inch wing span. Males are slightly smaller and distinctly darker than females.

## Economic Importance:

Economic importance of the European corn borer has greatly diminished in recent years, presumably from widespread use of Bt ECB hybrids. However, routine field scouting of Bt ECB hybrids and refuge is still suggested.

## Life Cycle:

The European corn borer overwinters as mature 5th instar larvae in corn stalks and stems of weedy hosts. Spring development begins when temperatures exceed 50 degrees F. Pupation occurs in May with the first moths emerging in early June in southcentral Wisconsin. Peak emergence occurs in mid June at 600 degree days (base 50). This generation usually infests corn and females will seek out the tallest field for egg laying. Adult moths are nocturnal and spend most of their daylight hours in sheltered areas along field edges. Female moths lay eggs in the evening. The eggs hatch in 3-7 days depending on the temperatures and young larvae feed on leaves and in the midrib of the leaves for 5-7 days (125 DD<sub>50</sub>) before boring into stalks. Boring usually begins with the third instar. The larvae pass through five instars and complete their feeding and development while boring inside stems. The earliest larvae to mature embark upon a 12 day pupal period within the stalk after which time the adult



moths emerge. This begins the second generation. Second generation moth's peak in mid August at approximately 1700 DD<sub>50</sub>. Newly hatched second generation larvae tend to migrate to leaf sheaths and beneath ear husks. Larvae enter the silk channel at the tip of the ear, tunnel up the shank and into the ear, or bore directly through the husks and into the ear. All mature 2nd generation larvae enter diapause in late September and October and overwinter. In seasons with unusually warm spring and summer temperatures, some of the second generation larvae will pupate, emerge as moths and lay eggs for a late-season, third generation of larvae. These larvae do not have a chance to become fully grown before cold weather arrives and ultimately will perish.

<b>European Corn Borer Development (DD base 50)</b>	
<b>First Generation</b>	<b>Accumulated DD</b>
First moth	375
First eggs	450
Peak moth flight	600
Larvae present	800-1000
2nd generation adults	1550-2100

### **Host Range:**

Corn borers attack over 200 different kinds of plants and may cause serious damage to field and sweet corn, peppers, potatoes and snap beans.

### **Environmental Factors:**

Cool weather or drought may delay spring insect development due to the desiccation of eggs and young larvae. Conversely, warm weather and moisture may accelerate insect development. Excessive heat and drought in spring may cause increased mortality of all stages. The number of eggs laid is affected by the availability of drinking water of which, dew is considered an important source. Heavy rainfall will decrease moth activity and drown newly-hatched larvae in whorls and leaf axils, or even wash them from the plant.

### **Damage/Symptoms:**

Damage to corn is caused by early larval stages chewing on the leaves and later larval stages tunneling into the stalks, ears and ear shanks. Early leaf feeding appears as pinholes, called "shotholes", as leaves emerge from the whorls. Third instar larvae begin to burrow into the midrib of the leaf, eventually working their way to the stalk. Severe feeding damage will result in broken stalks and tassels, poor ear development and dropped ears in dent corn.

### **Scouting Procedure/ET:**

Black light traps can be used to monitor adult corn borer activity. Moth catches provide data on the time of appearance and potential severity of the subsequent larval infestation.

**First Generation Scouting:** Once corn reaches 18 inches extended leaf height, examine 10 consecutive plants in 10 areas of the field for leaf feeding. Pull the whorl leaves from two infested plants in each area and unroll the leaves to look for borers. Calculate the percentage of plants with recent leaf feeding and average number of European corn borer larvae/infested plant and consult the management worksheet for first generation corn borer.

**Second Generation:** Second generation European corn borer egg laying occurs over a long period of time and infestations can go unnoticed until ears begin to drop and stalks begin to break in the fall. Due to the extended egg-laying period, one sampling of a field is not sufficient. Scout fields weekly

looking for white egg masses on the undersides of leaves near the midrib. Most of the eggs will be laid on leaves near the ear and above. Use the management worksheet for second generation corn borers to determine whether treatment will be worthwhile. If possible, treat when tiny black dots are apparent on most of the egg masses. At this “black-head” stage, the eggs are almost ready to hatch.

**Non-Chemical Control:**

**Natural Control:** Weather conditions greatly influence European corn borer survival, particularly during the egg stage and while young larvae are feeding on the leaves. Heavy rains wash the egg masses and young larvae off the plants and thus can greatly reduce borer numbers. In addition, very hot, dry weather causes desiccation of the eggs and young larvae. These climatic variables will kill 22-68% of the freshly hatched larvae. Predators, parasites and disease also take their toll on European corn borer populations; however there is no way to predict the impact of these factors.

**Cultural Control:** Plowing under crop stubble and shredding stalks on a community-wide scale in the fall to destroy overwintering larvae may reduce borer populations. However, moldboard plowing of fields is often unacceptable because of the potential for soil erosion and incompatibility with conservation plans. This, plus the fact that moths can fly several miles, and the wide host range of the European corn borer, limit the value of plowing under or shredding corn stubble.

**Biological Control:** Predators, parasites and disease also take their toll on European corn borer populations, however there is no way to predict the impact of these factors making them a less practical alternative.

**Chemical Control:**

Consult UW Extension Bulletin “Pest Management if Wisconsin Field Crops” A3646 for control recommendations. This bulletin maybe purchased from your local county extension office or is available to view, purchase or download from UW Cooperative Extension’s The Learning Store at <http://learningstore.uwex.edu/>

Insecticide Resistance: None.

**1<sup>st</sup> Generation European Corn Borer Management Worksheet**

% of 100 plants infested x  average # of borers/plant<sup>A</sup> =  average borers/plant

↓

average borers/plant x 5% yield loss per borer =  % yield loss

↓

% yield loss x  expected yield (bu/A) =  bu/A loss

↓

bu/A loss x  \$ expected selling price/bu =  \$ loss/A

↓

\$ loss/A x  % control<sup>B</sup> =  \$ preventable loss/A

↓

\$ preventable loss/A -  \$ cost of control/A =  \$ gain (+) or loss (-) per acre if treatment is applied

<sup>A</sup> Determined by checking whorls from 20 plants.  
<sup>B</sup> Assume 80% control for most products: assume 50% control for Asana, Furadan and Lorsban sprays.

## 2<sup>nd</sup> Generation European Corn Borer Management Worksheet

$$\square \text{ \# of egg masses /plant}^A \times 2 \text{ borers/egg mass}^B = \square \text{ borers/plant}$$

$$\square \text{ borers/plant} \times 4\% \text{ yield loss per borer}^C = \square \text{ \% yield loss}$$

$$\square \text{ \% yield loss} \times \square \text{ expected yield (bu/A)} = \square \text{ bu/A loss}$$

$$\square \text{ bu/A loss} \times \square \text{ \$ expected selling price/bu} = \square \text{ \$ loss/A}$$

$$\square \text{ \$ loss/A} \times 75\% \text{ control} = \square \text{ \$ preventable loss/A}$$

$$\square \text{ \$ preventable loss/A} - \square \text{ \$ cost of control/A} = \square \text{ \$ gain (+) or loss (-) per acre if treatment is applied}$$

<sup>A</sup> Use cumulative counts, taken seven days apart.

<sup>B</sup> Assumes survival rate of two borers per egg mass.

<sup>C</sup> Use 3% loss/borer if infestation occurs after silks are brown. The potential economic benefits of treatment decline rapidly if infestations occur after corn reaches the blister stage.

### References:

- R. H. Davidson and W. F. Lyon (1979) *Insect Pests* 7th Ed. of Farm, Garden, and Home. John Wiley & Sons, New York 596 pp.
- K. F. Harris and K. Maramorosch, Eds. (1980) *Vectors of Plant Pathogens*. Academic Press, New York 467 pp.
- C. L. Metcalf and R. L. Metcalf (1993) *Destructive and Useful Insects, their Habits and Control* 5th Ed. McGraw Hill Book Co., New York.

## Hop Vine Borer & Potato Stem Borer



Scientific Names: *Hydraecia immanis*, *Hydraecia micacea*

Order: Lepidoptera

Family: Noctuidae

## **Biological Description:**

Hop vine borer larvae are white with violet transverse bands. The head is orange to reddish-brown. Just prior to pupation, the violet bands disappear. By comparison, the larvae of the potato stem borer are white with reddish dorsal bands. The potato stem borer is a European relative of the hop vine borer and is almost identical in appearance but has a much wider host range. The distinctive coloration of the hop vine borer and potato stem borer will distinguish them from cutworms. Adult moths of both the hop vine borer and potato stem borer are non-descript brown to tan moths.

## **Economic Importance:**

The hop vine borer is a native, stem-feeding caterpillar that has caused localized damage to corn in portions of Wisconsin, Iowa, Illinois and Minnesota.

## **Life Cycle:**

These insects overwinter as eggs which were laid on grass stems in August. Larvae hatch from the eggs in May and begin feeding on grass stems and rhizomes. In late May, second or third instar larvae move from grassy weeds into adjacent corn to complete development. Larvae complete development after tunnelling in the below-ground portions of the stem in late June to mid July. Larvae pupate in the soil within a few inches of the last host plant. The pupal stage lasts 4-6 weeks and adults are present from late July until early September. There is only one generation per year.

## **Host Range:**

The potato stem borer feeds primarily on potato, eggplant and other solanaceous weeds while the hop vine borer prefers corn, hops, and various grasses.

## **Environmental Factors:**

Reduced tillage and poor grassy weed control favors both the hop vine and potato stem borers.

## **Damage/Symptoms:**

Damage is usually confined to the outer four to six rows of corn fields as the larvae migrate into corn from adjacent grassy areas. However, if corn follows sod or grassy weeds, outbreaks may be found throughout the field. The first indication of a hop vine borer or potato stem borer infestation is wilted corn plants. Unlike the common stalk borer which tunnels mainly in the corn stalk above ground, the hop vine and potato stem borers usually feed on the stem below ground.

## **Scouting Procedure and ET:**

To check for suspected hop vine and potato stem borers, remove damaged corn seedlings along with a 3-4 inch cube of soil. Look for entry holes in the stalk just below the soil surface, split the stalk, and sift through the soil. You may have to dig and examine several plants before finding any larvae.

## **Non-Chemical Control:**

**Natural Control:** The skunk is the only known natural enemy of hop vine borer and potato stem borer. However, skunks often cause additional damage to corn plants by digging the plants in search of the borers.

**Cultural Control:** Adequate management of grassy weeds is the primary means of successfully controlling both of these borers.

**Biological Control:** None.

## Chemical Control:

Consult UW Extension Bulletin “Pest Management of Wisconsin Field Crops” A3646 for control recommendations. This bulletin may be purchased from your local county extension office or is available to view, purchase or download from UW Cooperative Extension’s The Learning Store at <http://learningstore.uwex.edu/>

Insecticide Resistance: None.

## References:

C. L. Metcalf and R. L. Metcalf (1993) Destructive and Useful Insects, their Habits and Control 5th Ed. McGraw Hill Book Co., New York.

---

# Seed Corn Maggot



Scientific Name: *Hylemya platura* (Meigen)  
Order: Diptera  
Family: Anthomyiidae

## Biological Description:

The yellowish-white larvae are typical looking fly maggots, 1/5 inch long when fully grown, cream colored, legless and wedge-shaped with the head end sharply pointed. Pupae are brown, 1/5 inch long, cylindrical in shape, and rounded on both ends. Adults resemble miniature houseflies; they are dark grey, 1/5 inch long and their wings are held overlapped over their bodies while at rest. Flies are smaller than cabbage and onion maggots, with whom they are easily confused. Eggs are about 1/32 of an inch in length, oval, and white.

## Economic Importance:

Although seedcorn maggot is a threat to corn, damage is not as severe as that found on soybeans and other vegetables such as peas and succulent beans.

## Life Cycle:

The seedcorn maggot overwinters as pupae in the soil. Peak adult emergence from overwintering pupae occurs anytime from early to mid May when degree day accumulations have reached 200 DD<sup>39</sup> Newly emerged adults may be seen flying in large numbers over recently-tilled fields. Adults mate within 2-3 days of emergence and females lay eggs in soils containing high organic matter or near

seeds and seedlings of a wide variety of plants. Egg hatch occurs in 2-4 days. Larval feeding, development and pupation all occur below ground and the subsequent generation of adults appears 3-4 weeks later. This sequence of events is repeated and 3-5 generations of seedcorn maggots may occur during a season.

### **Host Range:**

Seeds and seedlings of corn, soybean most vegetable crops including beets, cabbage, cucumbers, peas, radishes, squash, turnips, and kidney, lima and snap beans.

### **Environmental Factors:**

Cool, wet weather favors this insect while hot, dry weather is detrimental to its survival. Therefore, the seed corn maggot is more likely to be a problem during the spring and early summer than later in the season. Cool, wet springs and doughty conditions may delay seed germination and lead to increased damaged by the seed corn maggot. The application of livestock manure and incorporation of vegetation prior to egg laying makes fields more attractive to the female flies. Tillage of live plant material is more attractive than tillage of dead plant residue. The decomposition of the green vegetation may produce compounds that attract the flies.

### **Damage/Symptoms:**

All parts of sprouting corn seeds are attacked by the maggot larvae, resulting in weakened, stunted plants and poor germination rates. Plants which survive maggot damage to the seed often have holes in the first pair of true leaves. Extensive feeding on seed endosperm can reduce plant vigor and lead to small “nubbin” ears. Larvae feeding on the seed germ will destroy the seed and prevent seedling emergence. Unlike the spotty nature of wireworm damage, seedcorn maggot damage will usually cover most of the field.

### **Scouting Procedure and ET:**

Seedcorn maggot damage cannot be detected until it is too late to take control actions. Therefore, economic thresholds for this insect are not useful and insecticides are applied at planting as a protective measure. However, if you notice skips in the row, wilted, yellowed or stunted plants, or seedlings with pinholes in the leaves check for seedcorn maggots. If numbers justify it, check 50 plants in 5 separate field areas to both verify and quantify seedcorn maggot injury. Forecasting the appearance of generations may be accomplished by accumulating degree days beginning when the ground thaws in spring. Degree days are calculated each day using the formula  $((\text{maximum temperature} + \text{minimum temperature})/2)$  39. A running total of degree days is kept and peak emergence of the first three generations will occur when totals of 200, 600 and 1000 day degrees, respectively, have been reached.

### **Non-Chemical Control:**

**Natural Control:** Naturally occurring fungal diseases occasionally will reduce seedcorn maggot numbers significantly, particularly when flies are abundant and relative humidity is high. During a fungal epidemic, dead or diseased flies can be seen clinging to the highest parts of plants along field edges. Predaceous ground beetles, which eat seedcorn maggot eggs, larvae and pupae can also be important in reducing maggot numbers. Because these soil inhabiting beetles are susceptible to insecticides, broadcast soil insecticide treatments should be avoided whenever possible.

**Cultural Control:** Since the seedcorn maggot is attracted to decaying organic matter, fields where animal or green manure has recently been applied should not be planted. Plant seeds as shallow as feasible to speed germination. Any procedure which promotes fast germination and seedling growth will reduce chances of maggot infestation. In addition, home gardeners may soak seeds in water for about 2 hours prior to planting to promote fast germination and seedling growth. It is also possible to avoid



seedcorn maggot damage by planting during fly free periods that occur between generations of flies (see Scouting/ET).

**Biological Control:** None.

**Chemical Control:**

Consult UW Extension Bulletin “Pest Management if Wisconsin Field Crops” A3646 for control recommendations. This bulletin maybe purchased from your local county extension office or is available to view, purchase or download from UW Cooperative Extension’s The Learning Store at <http://learningstore.uwex.edu/>

Insecticide Resistance: None.

**References:**

- R. H. Davidson and W. F. Lyon (1979) Insect Pests 7th Ed. of Farm, Garden, and Home. John Wiley & Sons, New York 596 pp.
- C. L. Metcalf and R. L. Metcalf (1993) Destructive and Useful Insects, their Habits and Control 5th Ed. McGraw Hill Book Co., New York 1087 pp.
- S. M. Sanborn, J. A. Wyman and R. K. Chapman. “Threshold Temperature and Heat Unit Summations for Seedcorn Maggot Development Under Controlled Conditions.” Annals of Entomology. Vol. 75, No. 1 103-106.

---

## Stalk Borer



Scientific Name: *Papaipema nebris*

Order: Lepidoptera

Family: Noctuidae

**Biological Description:**

The larvae are purplish brown with longitudinal, off-white stripes running the length of their body. There is a purplish band located behind a yellow head. They range from 1/2 to 1 1/2 inches long and are extremely active when disturbed. Adult moths have dark grey-brown forewings with numerous small, white spots. The wingspan is approximately 1 1/4 inches.

**Economic Importance:**

Damage to corn by the common stalk borer and other borers besides the European corn borer tends to be localized and less common. In recent years however, this insect has become relatively common in some parts of the state.

## Life Cycle:

Adult female stalk borers lay up to 2,000 eggs in late August and September in grassy weeds (especially quackgrass and wire-stem muhly), ragweed, pigweed, curlydock, burdock. The eggs overwinter and hatch in early spring (mid-April to early May). As the larvae grow, the grass stems become too small and by late May to early June larvae begin to migrate from the grassy field borders into the border rows of adjacent crops. Larvae are fully grown in early August and may bore into many stems before pupating in the soil. Adults emerge 2-6 weeks later (late August) and seek grassy areas in which to oviposit. There is one generation/year.

## Host Range:

The host range of the common stalk borer is comprised of over 170 species. This insect attacks virtually any plant large enough for it to bore into, including all beans, corn, and potatoes.

## Damage/Symptoms:

There are basically two types of damage caused by the common stalk borer in corn. In the first, the larva enters the corn plant near the base of the plant and tunnels within the stem. Stem tunneling in seedling plants causes unfurled leaves to wilt and flag. Seedling plants may be killed by this tunneling activity, and the larva will move to another plant if the food supply is exhausted. In the second case, the stalk borer larva enters the whorl and feeds there before tunneling downward. This results in numerous larval droppings (frass) and a series of irregular holes in the unfurled leaves.

## Scouting Procedure/ET:

Record % of plants infested. Draw accurate field maps if damage is concentrated in specific areas (e.g. field edges, grassy waterways, fence rows or where grassy weeds were growing the previous growing season) so spot applications can be made if necessary.

## Non-Chemical Control:

**Natural Control:** Populations seem to build and decline in 4-6 year cycles but the reasons for this are not understood. Natural enemies of the common stalk borer include a tachinid fly (*Gynmochaeta ruficornis*), an ichneumonid wasp (*Lissonota brunner*) and two braconid wasps (*Meteorus leviventris* and *Apanteles papaipemae*).

**Cultural Control:** Cultural control is by far the most important control for this pest. Poor weed control during the previous year provides numerous oviposition sites and can result in extensive patches of crop damage the following year. Keep fall weeds, especially grasses, controlled to prevent egg laying. Mowing fence rows in mid August as eggs are laid may also help to reduce next season's populations.

**Biological Control:** There are no commercially available biological control agents which are cost effective to use to reduce stalk borer populations.

## Chemical Control:

Consult UW Extension Bulletin "Pest Management in Wisconsin Field Crops" A3646 for control recommendations. This bulletin may be purchased from your local county extension office or is available to view, purchase or download from UW Cooperative Extension's The Learning Store at <http://learningstore.uwex.edu/>

Insecticide Resistance: None.

## References:

J.L. Wedberg & B.L. Giebink. (1986) UWEXnote 5 - Stalk-Boring Insect Pests of Corn. University of Wisconsin Agricultural Bulletin Office. Madison, WI 4 pp.

R. H. Davidson and W. F. Lyon (1979) *Insect Pests of Farm, Garden, and Home*. 7th Ed. John Wiley & Sons, New York 596 pp.  
C. L. Metcalf and R. L. Metcalf (1993) *Destructive and Useful Insects, their Habits and Control* 5th Ed. McGraw Hill Book Co., New York.

---

# Western Bean Cutworm



Scientific Name: *Loxagrotis albicosta*  
Order: Lepidoptera  
Family: Noctuidae

## Biological Description

Young western bean cutworm larvae are dark colored and have faint diamond-shaped markings on their back. As they mature, larvae become brown in color and have 3 distinct stripes behind the head. The adult moth is approximately  $\frac{3}{4}$  inch long and have a 1  $\frac{1}{2}$  inch wing span. The forewings are brown and have a conspicuous white colored stripe on the leading edge of the wing. Eggs are round and laid in clusters which are whitish when first deposited, turn tan after a few days then eventually turn a dark purple just prior to hatch.

## Economic Importance

Historically, the western bean cutworm was a pest on corn and dry beans in the western corn belt. The first detection of western bean cutworm in Wisconsin was 2005 and their numbers have steadily increased, especially in the sandy areas of the state.

## Life Cycle

Western bean cutworm has one generation/year in Wisconsin. They overwinter as fully grown larvae in earthen cells and pupate in May. Adults emerge late June and are attracted to late vegetative corn to lay eggs. Eggs are usually laid on the upper most leaves. After hatching, larvae will feed on pollen or, if the ear has emerged, on silk before moving into the ear to feed on developing kernels. Large areas of kernels may be consumed. When development is complete, larvae will move to the ground where they create a earthen chamber and overwinter.

Degree Days (DD) are an excellent tool for monitoring adult western bean cutworm development. Begin calculating degree days using a base temperature of 50°F on May 1. Approximately 25% of moths will be emerged at 1319 DD, 50% at 1422 DD and 75% emergence at 1536 DD.

## Host Range

Western bean cutworms are a pest of dry beans (not soybean) and corn. In dry beans young larvae will feed on flower parts and newly emerged leaves. Economic damage occurs when larvae mature and begin to feed on pod and developing seeds.

## **Damage/Symptoms**

After hatching, larvae from a single egg mass will often disperse to adjacent plants. If corn has not tasseled, larvae will feed on pollen in the developing tassel. After tassel emergence larvae feed on silk and developing kernels by first traveling through the silk channel or chewing through the husk. Research has shown that an infestation of one larvae per ear may result in a 4 bu./acre yield loss. Several larvae/ear may reduce yield by 30-40%. Additionally, kernel injury may allow for entry and colonization of fungal pathogens.

## **Scouting Procedure and Economic Threshold**

Use of a pheromone trap, along with degree days, will help determine field scouting activities. Pheromone traps can easily be made from plastic milk jugs and the pheromone lure purchased by several on line sources (eg. Gemplers [gemplers.com] and Great Lakes IPM [http://www.greatlakesipm.com/]) . Traps should be set out by July 1. For more information on trap design, materials, maintenance and placement go to <http://www.ext.colostate.edu/pubs/insect/05538.html>

Time field scouting activities using degree days and pheromone trap catches. Examine 20 consecutive corn plants at each of five locations/field. Look for eggs and or larvae on the upper leaves and continue scouting at weekly intervals until after the threat of western bean cutworm has subsided. For field corn, consider treatment when 8% or more of the corn plants have either eggs or larvae present, but before larvae have entered the ear. Once larvae have entered the ear they are not susceptible to insecticide applications.

## **Non-chemical control**

Natural control factors, like rain or temperature extremes, can increase larval mortality. However, cultural control practices like tillage have not consistently demonstrated control.

## **Chemical Control**

Several insecticides have demonstrated effectiveness for control of western bean cutworm. Timing of application is critical and should be coupled with field scouting activities to achieve effective and economical control. Consult UW Extension Bulletin "Pest Management in Wisconsin Field Crops" A3646 for insecticide control recommendations. This bulletin may be purchased from your local county extension office or is available to view, purchase or download from UW Cooperative Extension's The Learning Store at <http://learningstore.uwex.edu/>

---

# White Grub



Scientific Name: *Phyllophaga* spp.  
Order: Coleoptera  
Family: Scarabidae

## Biological Description:

Grubs are white-bodied, up to 1 1/2 inches in length, sluggish, C-shaped larvae with brown heads and six prominent brown legs. The hind part of body is smooth with body contents showing through skin. True white grubs are distinguished from similar larvae by 2 rows of minute hairs on the underside of the last segment. Adults are the common brown to black May or June beetles seen in the spring. There are several species of white grub in Wisconsin; they typically have 3-year lifecycles. Adult activity is primarily nocturnal.

## Economic Importance:

White grubs are typically only a problem in corn following sod or when weeds are not controlled. However, damage to corn following soybeans has been reported periodically.

## Life Cycle:

Most species have a three year life cycle in Wisconsin. Adults emerge and mate in late May to early June. Females search out grassy areas, burrow into the soil and deposit eggs. Eggs hatch in 2-3 weeks and grubs begin feeding on roots and underground plant parts. With the onset of cold weather, the grubs move beneath the frost line in the soil to overwinter. In May, to early June the grubs migrate back to the upper soil horizons. It is during the second year that the most damage is done as larvae increase in size before they return to the subsoil layers to overwinter. In the third spring, the grubs return to the surface, feed for a short time and pupate. In late summer, adults emerge from the pupae but remain underground until the following spring. Historically, Peak adult flights occur in Wisconsin every three years.

## Host Range:

Many species of crops are attacked. All vegetables, strawberries, roses, nursery stock, and most grass and grain crops are susceptible to grub damage.

## Environmental Factors:

White grub injury is typically a problem in areas which were previously planted to sod.



## **Damage/Symptoms:**

Damage is usually patchy, rather than randomly distributed throughout the field. They do not damage planted corn seed but rather prune and destroy corn roots and will burrow into corn stalks below ground. Small areas of infested fields may be totally destroyed. Plants may be wilted, stunted and under heavy infestations, can easily be lifted from the ground. Damage is most severe in years following peak adult flights and is most pronounced in corn following sod or fields with grassy weeds.

## **Scouting Procedure/ET:**

Routing scouting is not suggested. However, damage may be observed during seedling stand counts or cutworm surveys. If signs of white grub damage are found, count the number of grubs on 25 plants in five areas of the field. Dig plants suspected of being infested and examine the roots for signs of pruning. Search for grubs in the soil immediately surrounding the root zone. Record the number of damaged plants and number of grubs found.

## **Non-Chemical Control:**

**Natural Control:** A parasitic fly *Pyrogota* spp. parasitizes the grubs and may reduce populations. Birds are effective predators in freshly plowed fields.

**Cultural Control:** The first year after sod or grassy, weedy alfalfa will be the most damaging. Keeping grass weeds down in spring will prevent egg laying.

**Biological Control:** Commercial preparations of milky spore disease are rarely effective.

## **Chemical Control:**

Consult UW Extension Bulletin "Pest Management in Wisconsin Field Crops" A3646 for control recommendations. This bulletin may be purchased from your local county extension office or is available to view, purchase or download from UW Cooperative Extension's The Learning Store at <http://learningstore.uwex.edu/>

Insecticide Resistance: None.

## **References:**

R.H. Davidson and W.F. Lyon (1979) *Insect Pests 7th Ed. of Farm, Garden, and Home*. John Wiley & Sons, New York. 596 pp.  
C.L. Metcalf & R.L. Metcalf (1993) *Destructive and Useful Insects, Their Habits and Control*. 5th Ed. McGraw Hill Book Co., New York.

---

# Wireworm



Scientific Name: Many species and genera  
Order: Coleoptera  
Family: Elateridae

## Biological Description:

The larvae of click beetles, called wireworms, are the damaging stage of this insect. Larvae are thin, yellow to reddish brown, shiny, jointed, worm-like larvae, 1/4 to 1 1/2 inch in length by 1/8 inch in diameter. They are distinguished by the ornamentation on the last segment. Adults are hard shelled, brown or black “streamlined” beetles which flip into the air with an audible click if they are placed on their back.

## Life Cycle

Wireworms have an extended life cycle, taking from 1-6 years depending on species. In Wisconsin, wireworms overwinter as either adults or larvae. Larvae live in the upper six inches of soil and feed on seeds and roots. They migrate only short distances. They are sensitive to moisture and may burrow deeply into the soil in dry conditions. Adults become active in the spring as they fly about searching for a site on which to lay eggs. Adult females may live 10-12 months, spending most of this time in the soil where they may lay up to 100 eggs. Eggs are laid in soil in grassy areas. This includes pastures, alfalfa, sod, and grassy weed infestations in row crops. Egg hatch occurs in several days to weeks. Tiny larvae immediately begin to feed on the roots of grasses, weeds and other crops. Because of the extended life cycle, larvae of some species will feed for two to three years before pupating. Adults that emerge from these pupae remain in the pupal chambers until the following spring.

## Environmental Conditions

Wireworms tend to be most damaging 1-4 years after plowing up sod or in poorly drained lowlands, but they are not exclusive to those areas.

### Host Range

Wireworms feed primarily on grasses, including corn and small grains as well as nearly all wild and cultivated grasses. Favored row crops include beans, beets, cabbage, carrot, lettuce, onions, peas, potato, radish, turnips, sweet potatoes, cucumber, and tomato. Asters, phlox, gladioli, and dahlias are some of the more commonly infested herbaceous ornamentals.

## Damage/Symptoms

Damage is most likely to occur when infested pastures or alfalfa sod are plowed under and planted to row crops. Because of the long life cycle of wireworms, damage is possible two to three years after

the field is taken out of sod. A second year of corn after sod may have more damage than the first year, perhaps because there are fewer grass roots to feed on. Damage to the ungerminated seed occurs when wireworms hollow out the seed, thus preventing germination. Later, they feed on below ground portions of the stem. They drill a hole into the stem and occasionally drill completely through it. Stems of small seedlings may be hollowed out up to the soil surface. By midsummer, soil temperatures have increased and soil moisture is reduced. At this time, wireworms and their damage often disappear when in fact the wireworms have merely migrated deeper into the soil. Early indications of wireworm damage to corn is the lack of germination which results from the destruction of the seed. Only a few plants may remain in a heavily infested area. The first few leaves of emerging seedlings will often show a pattern of holes which is caused by wireworms feeding through the leaves before they unfurl. Stem feeding caused plants to wilt and die, further adding to the “spotty” appearance of the field. On larger plants, only the center leaves may wilt. If these plant do not die, they are usually stunted and distorted, and will not produce a normal ear.

### **Scouting Procedure/ET**

Scheduled scouting is not suggested. However, symptoms of wireworm activity may be observed during seedling stand counts or cutworm scouting. No thresholds have been developed. If wireworm damage is suspected, dig up several ungerminated seeds or damaged plants along with a 4-6 inch core of surrounding soil and check for wireworms in and around the roots, or in the underground portion of the stems.

### **Non-Chemical Control**

Natural Control: Several natural enemies have been described but they are not effective in reducing populations.

Cultural Control: Crop rotations which avoid susceptible crops and clean cultivation may reduce wireworm numbers. Some species thrive in poorly drained soil and can be reduced by adequate drainage. Clean summer fallowing of infested fields has been effective in some areas. Certain soil types (e.g. silt loams) are particularly susceptible.

### **Chemical Control:**

Consult UW Extension Bulletin “Pest Management if Wisconsin Field Crops” A3646 for control recommendations. This bulletin maybe purchased from your local county extension office or is available to view, purchase or download from UW Cooperative Extension’s The Learning Store at <http://learningstore.uwex.edu/>

Insecticide Resistance: None.

### **References:**

- R. H. Davidson and W. F. Lyon (1979) *Insect Pests of Farm, Garden, and Home*. 7th Ed. John Wiley & Sons, New York 596 pp.
- C. L. Metcalf and R. L. Metcalf (1993) *Destructive and Useful Insects, their Habits and Control* 5th Ed. McGraw Hill Book Co., New York.

# Field Crop Insect Stages

Insect management decisions should be based on the potential for economic damage. In order to determine damage potential, the size and number of larvae and the number of remaining insect stages must be known. Certain insects can very quickly become major pests on field crops because as insects grow, they eat more each day.

Although small larvae are usually not damaging, larvae can become devastating in a few days as they near maturity. Sixth-stage green cloverworm larvae, for example, may consume 75% of their larval food during the last six days of the 23-day larval life. Damage, however, will quickly subside after the insects have pupated.

As larvae grow, they molt, or shed their skins. The stage between molts is called the **instar**. Most field crop insects have 3 to 7 larval stages. For example, the European corn borer has 5 larval stages, the black cutworm has 7, and the western corn rootworm 3.

During a stage the larva's body grows but its head does not increase in size. Only between stages does the size of the head increase. Identification of larval stages can be partially determined by the length of the larva. The most accurate method, however, is measuring the width of the head capsule. An exception is the European corn borer, where measuring the width of the prothoracic shield is more accurate than measuring the width of the head capsule.

Head capsule (or prothoracic shield) measurements and approximate body lengths corresponding to larval stages are given for 7 common crop insects. Approximate lengths are illustrated. For body length measurements, the unshaded portion is the range corresponding to the particular larval stage. For example, for the fourth stage of black cutworm, the dark portion of the line is equal to 12 mm. The unshaded portion is the 12 to 25 mm range in body length for the fourth larval stage. The stages within the brackets are considered to be the most destructive.

## Black cutworm—*Argrotis ipsilon* (Hufnagel)

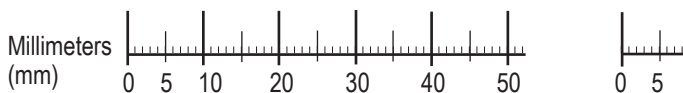
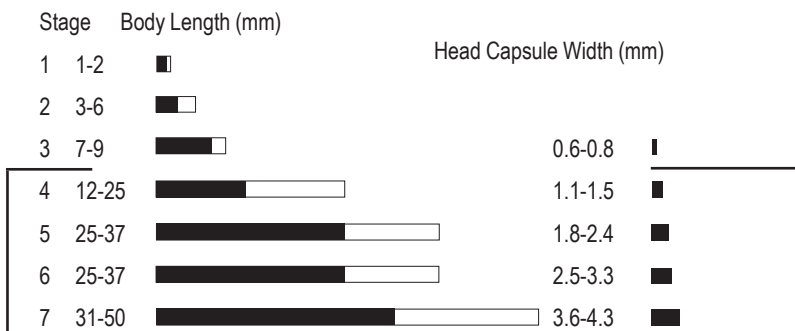

## European corn borer—*Ostrinia nubilalis* (Hübner)

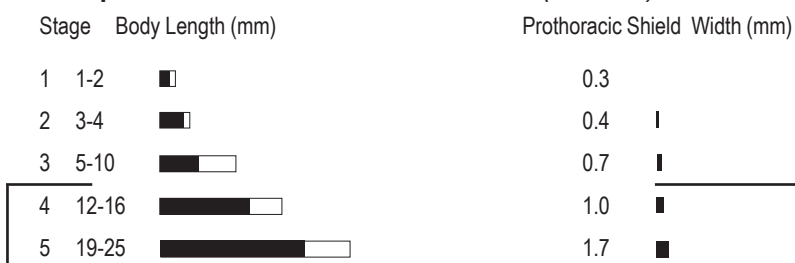

Prothoracic Shield

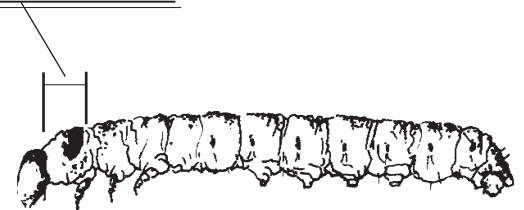

**Armyworm—*Pseudaletia unipuncta* (Haworth)**

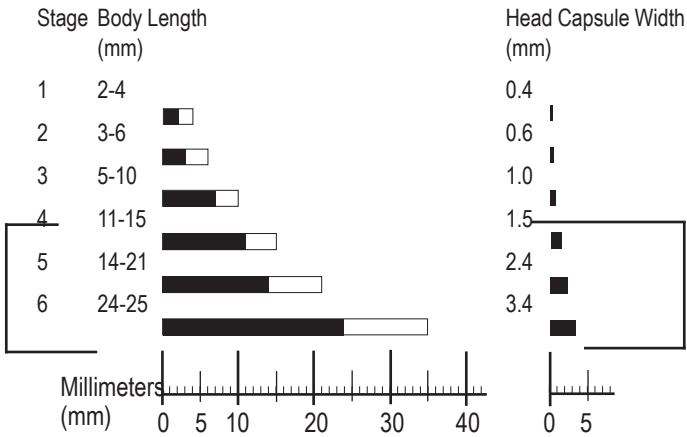

**Alfalfa weevil—*Hypera postica* (Gyllenhal)**

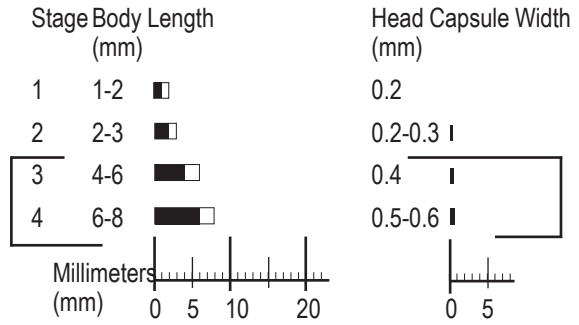

**Corn earworm—*Heliothis zea* (Boddie)**

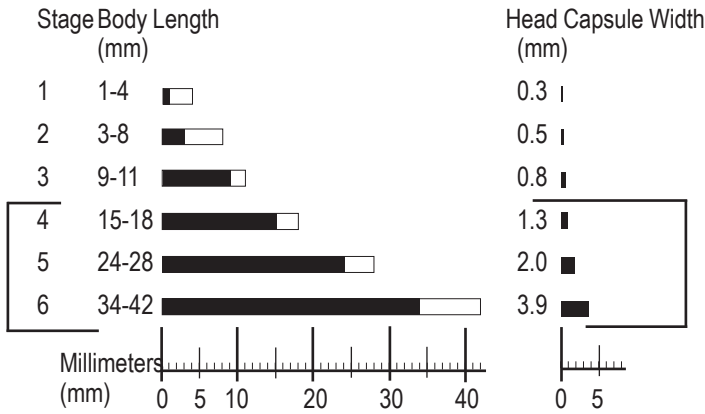

**Western corn rootworm—*Diabrotica virgifera* LeConte**

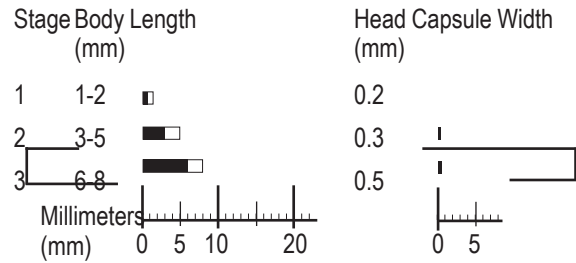

**Green cloverworm—*Plathypena scabra* (Fabricius)**

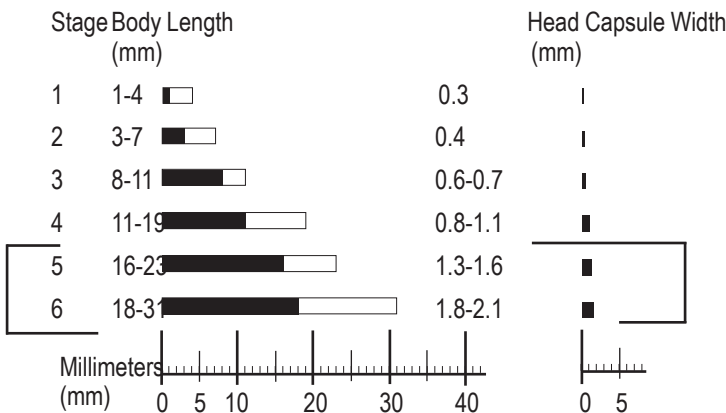

All information in this Field Crop Insect Stages sheet, taken from Iowa State University of Science and Technology, Cooperative Extension Service, publication prepared by Jerry DeWitt, integrated pest management coordinator, and Harold Stockdale, extension entomologist at the Cooperative Extension Service, Iowa State University.



# Key: Types of “Worms” Found in Corn & Alfalfa Fields

1. Worms without legs	1/8” to 1/2” long, often spindle-like or peg-shaped Maggots (fly larvae)
-----------------------	---

1 <sup>1</sup> . Worms with 6 or more legs	2
--	---

2. Worms with only 6 legs	Beetle larvae <i>Coleoptera</i>
---------------------------	---------------------------------

2 <sup>1</sup> . Worms with more than 6 legs	3 (see figure 1)
--	------------------



figure 1

3. Worms with 6 pointed legs on front of body and 10 to 14 blunt legs on middle and rear of body	4
--	---

3 <sup>1</sup> . Worms with 15 or more pairs of legs, legs all of same size and shape, two pair of legs per segment	Millipeds—(see figure 2) feed on organic matter
---	--



figure 2

4. Worms with 6 pointed legs on front, 10 or less blunt prolegs on middle and rear of body, each proleg has group of small hooks at tip	True Caterpillars— <b>Go on to next page</b>
---	--

4 <sup>1</sup> . Worms with 6 pointed legs, plus 14 blunt prolegs, no hooks on ends of proleg, only one pair of eyes on head	Sawflies—(see figure 3) feed on weeds
--	--

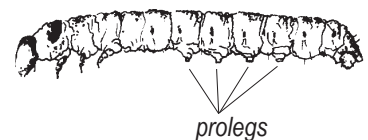

figure 3

# Wisconsin Field Pest Caterpillar Key

This key has been put together to help in the identification of the more common general pest caterpillars in Wisconsin. It will by no means identify everything in the field, but should work for 80% of the worms found. Such things as when, what crop and where on the plant the insect is found are important aids in identification and are included whenever practical in this key. Read through the total description of each insect before making your decision on which direction to go. Most characteristics can be observed with a 10X hand lens. Looking at the skin texture will require good light and a 15-20X lens. Worms over 1" in length will be easier to work with. Whenever possible, a series of specimens should be used for ID purposes.

---

A. Two pair of ventral prolegs on abdomen      B (see figure 1)

---

A<sup>1</sup>. Four pair of ventral prolegs present on abdomen      C (see figure 4)

---



figure 1

---

B. General color green, body thick with thin white line on side. Most often found in cole crops and potatoes. Does not appear until late July.      **Cabbage Loper** *Trichoplusia ni*

---

B<sup>1</sup>. General color light tan to pink, head with distinct white, brown or pink stripe. Usually associated with clover or alfalfa      **Forage Loper** *Caenurynia erectea*

---



figure 3

---

C. Caterpillar with very distinct, sharply defined stripes along back or sides      D

---

C<sup>1</sup>. Caterpillar without distinct, prominent stripes. J May have indistinct bands or markings

---

D. Skin covered with densely packed microspines (see figure 5). Larvae variable in color. Dark brown to green or yellow with lengthwise light and dark stripes. Found in corn silks, ears and tomatoe fruit. Not found in Wisconsin until July or later.      **Corn Earworm** *Helicoverpa zea*

---

D<sup>1</sup>. Skin not as above, but may have pebbly texture      E

---

E. Purple ringed area around middle of body. Body whitish with dark brown lateral stripes. Larvae most often boring into stem of corn, potatos, peppers, tomatoes during June and July.      **Common Stalk Borer** *Papipama nebris*

---

E<sup>1</sup>. No purple saddle around middle of larvae      F

---



figure 5

F. Prominent light colored, inverted Y on head. **Fall Armyworm** *Spodoptera frugiperda*

Body tan, green or black. Back somewhat lighter colored, dark side stripes running length of body. Prothoracic shield usually with 3 pale yellow lines. Four spots (pinacula) arranged as points of square on back of next-to-last abdominal segment. Spiracles with lighter center. Found only in late summer in corn ears or rarely in grain fields.

---

F<sup>1</sup>. Body with various markings. **G**  
Larvae not as above. Found throughout growing season, rarely found in corn ears.

---

**G**. Several thin, prominent bright yellow side stripes. Large black spot above first abdominal spiracle and double row of black triangular markings on most of back. Spiracle, gray center with dark rim (general feeder). Found on vegetables from mid June on. **Yellow-Striped Armyworm** *Spodoptera ornithogalli*

---

**G<sup>1</sup>**. NO yellow stripes or black spot on first abdominal segment. Spiracle totally black or with white center. If black markings present on back, never present on more than 1/2 of larvae. **H**

---

**H**. Spiracle white or yellowish center, prominent black chevron wedge shaped markings on last 2 abdominal segments. Pale pink or orange side stripe present. Large larvae found in Spring on alfalfa—Fall. General feeder. Often in mixed infestation of true Armyworm. **Spotted Cutworm** *Amathes C-nigrum*

---

**H<sup>1</sup>**. Spiracle black. If markings on back, they are all defined and not as above. **I**

---

**I**. No distinct lines on back. A row of 4-7 pale yellow spots along center of back. In dark colored forms, a black W-shaped spot found on last abdominal segment. Larvae black to pale brownish gray. Jaws with sharp teeth. General feeder. A climbing cutworm on tree fruits in Spring, strawberries, potato, general vegetables. **Variiegated Cutworm** *Paridroma saucia*

---

**I<sup>1</sup>**. Back of caterpillar with numerous lines running lengthwise. No light spots on back. Jaws without teeth. Light to pink side stripe present. Most common on corn and various small grains. From mid June and July. Often associated with weedy grasses. **True Armyworm** *Pseudaletia unipunta*

---

**J.** Caterpillar with some striping on body—  
may be inconspicuous.

**K**

---

**J<sup>1</sup>.** Caterpillar with no stripes (may have  
small spots). All whitish or gray.

**N**

---

**K.** Caterpillar with several indistinct stripes  
on BACK.

**L**

---

**K<sup>1</sup>.** Caterpillar with no stripe or only one broad  
(or narrow) inconspicuous stripe on BACK.

**M**

---

**L.** Skin bearing coarse granular (*see figure 4*).  
Caterpillar dingy brownish tan. Faint V-shaped  
markings on back. Spiracles black. Found on  
alfalfa, corn and vegetables.

**Dingy Cutworm** *Feltia ducens*, *F. subgothica*

---

**L<sup>1</sup>.** Skin smooth. Caterpillar dull gray with  
prominent dark gray side stripe above spiracles.  
Sides darker than back. Spiracles dark brown.  
On tree fruits, onion, potato, corn. Can climb.

**Dark Sided Cutworm** *Euxoa messoria*

---

**M.** Skin granules appear greasy under hand  
lens (*see figure 6*). Body is light gray to black.  
Narrow indistinct striped down middle of back.  
No distinct spots. Spiracles and tubercles black.  
Most common cutworm in Wisconsin. Seen in  
corn, turf and vegetables.

**Black Cutworm** *Argrotis ipsilon*

---

**M<sup>1</sup>.** Caterpillar with skin granules, 4-6 sided  
(*see figure 7*). Body pale gray with broad,  
tanish stripe on back. Spiracles black.  
Occasional pest of corn, strawberries,  
general vegetables.

**Clay-Backed Cutworm** *Argrotis gladiaria*

---

**N.** Caterpillar with head and neck shield bright  
reddish brown. Body greasy white and very  
plump. No conspicuous markings or stripes on  
body. Spiracles brown, mandible with four  
distinct, blunt outer teeth and three inner teeth.

**Glassy Cutworm** *Crymodes devastator*

---

**N<sup>1</sup>.** Not as above. Head pale brown to black.  
Dull. Body normal size. Some spots or  
indistinct markings.

**O**

---

**O.** Head pale brown. Body semi-translucent  
with several white side stripes. Spiracles black.  
Larva limited to sandy soils. Most often feeding  
at or below ground level.

**Sand Hill Cutworm** *Euxoa detersa*

---

**O<sup>1</sup>.** Head dark brown to black. Body grayish to  
yellowish white. Distinct hair bearing spots on  
body. Spiracles light brown with yellow rim.  
Most often found boring into stem on fruit of the  
plant. Primarily on corn, tomato, pepper, potato.

**European Corn Borer** *Ostrina nubalis*

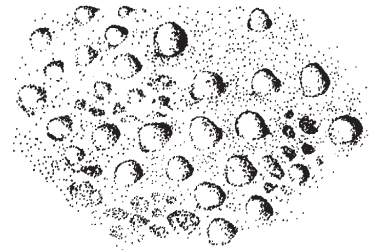

figure 4

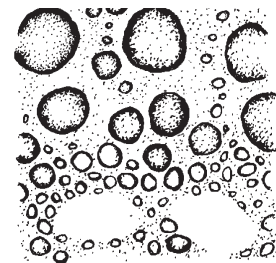

figure 6

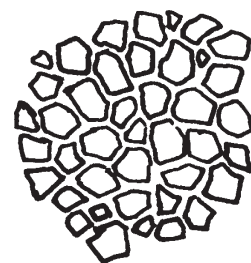

figure 7



# Quick Reference Photos

## Field Corn Insects



Anthracnose



Anthracnose



Northern Corn Leaf Blight

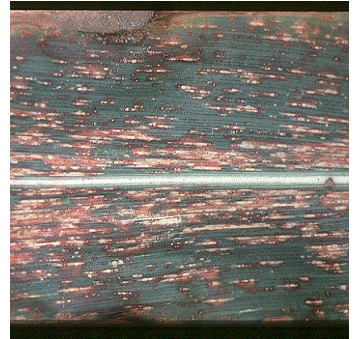

Northern Corn Leaf Spot

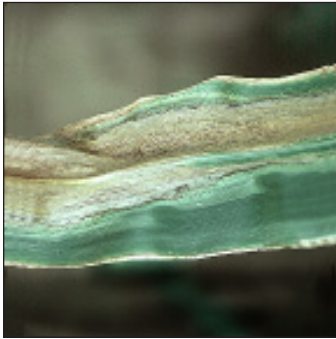

Goss Bacterial Wilt



Stalk Rot  
*Larvae*



Stalk Rot  
*Lodging*



Corn Ear Rot



Seedling Blight



Seedling Rot



Nematodes  
*Root Damage*



Nematodes  
*Stunting*

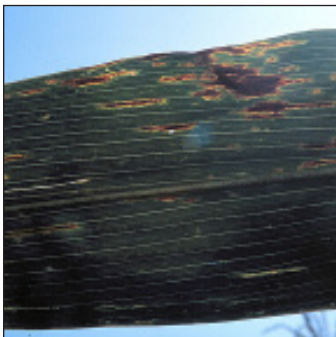

Gray Leaf Spot

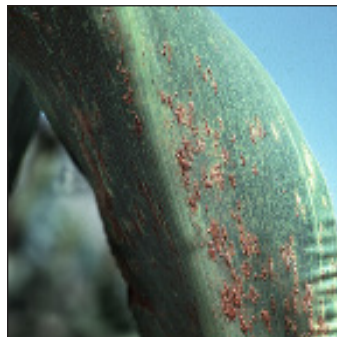

Rust

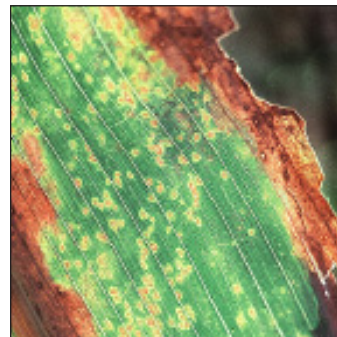

Eye Spot  
*Blacklighted*



Yellow Leaf Blight

# Corn Disease Management

*Dr. Craig Grau, Department of Plant Pathology, University of Wisconsin–Madison*

Diseases of corn, like those of other crops, vary in severity from year to year and from one locality or field to another, depending on environmental conditions, the resistance of the corn hybrid grown, and the disease-causing organisms that are present. It is important for growers to distinguish when poor crop development is due to diseases and when nutrient deficiencies, herbicide injury, insect injury, or weather conditions are the problem.

## General Approaches to Disease Control

Corn diseases can be prevented or controlled by planting resistant or tolerant corn hybrids, crop rotation, tillage practices, balanced fertility and applying pesticides. Although a single control procedure can be effective, a sound disease control program is an integration of all these crop management factors. An integrated approach can greatly reduce the potential risk of disease. Disease potential has increased because of the trend to shorten crop rotation and reduce or eliminate tillage operations.

## Resistant Hybrids

Selecting corn hybrids that have resistance or tolerance to major corn diseases can be an effective and economical method to disease control. Your seed dealer is a good source of information on specific hybrid reaction to disease. Terms describing hybrid reaction to disease are somewhat confusing. “Disease-resistant hybrids should be regarded only as a general term that suggests resistance to specific diseases—it cannot be an all-inclusive statement, since no hybrid is resistant to attack by all diseases known to affect the crop.

Many hybrids have good resistance or tolerance to most of the major diseases likely to occur in Wisconsin. Such diseases include rust, northern leaf spot, smut, stalk rot, *Gilberella* ear rot, Goss’s wilt, northern corn leaf blight (NCLB), southern corn leaf blight (SCLB), yellow leaf blight (YLB), and eyespot. If you have had a history of problems with one or more of these diseases, ask your seed dealer about hybrid reactions to these specific diseases.

Also, “resistance” does not mean “immunity”—complete freedom from infection or disease development. A resistant hybrid will withstand damage, but may show some disease development when conditions favor the disease. Some hybrids can also tolerate infection to certain diseases, that is, show considerable disease development, yet not suffer much yield reduction. In other words, there is a gradation among hybrids ranging from susceptible, to tolerant, to resistant, to highly resistant to disease. Changes in cultural practices, new forms (races) of known corn pathogens, and new corn pathogens can result in more disease in corn hybrids that were thought resistant. Learn to identify the major diseases of corn and evaluate disease reactions of the hybrids you grow. Disease reactions of various hybrids can differ with each year or locality because of different local weather conditions, tillage operations, soil type and soil fertility.

## Crop Rotation and Tillage Practices

Crop rotation and clean tillage are effective disease control procedures. In many cases, the fungi that cause corn diseases must overwinter on or in stalks, leaves, and roots. Once this corn debris is thoroughly decayed, corn pathogens perish or are greatly reduced in population. Therefore, crop rotation and tillage programs that permit residue decay before the next corn crop is grown in a given field will help reduce diseases such as ear rots, stalk rots, root rots, seedling blights, and leaf diseases.

We support the concept of no-till or minimum tillage for crop production for its soil conserving potential. However, growers using no-till or minimum tillage should be more alert for an increase in crop pest problems and be aware that the potential is greater with reduced tillage than with conventional tillage systems. The risk of increased corn disease problems is high when reduced tillage is associated with continu-



ous corn, planting of susceptible hybrids, and climatic conditions favorable for disease development. Continuous corn in conjunction with reduced tillage techniques increases the risk of disease. The need for disease-resistant hybrids increases under such practices. If you are considering continuous reduced tillage or no-till corn production, we suggest the following steps to minimize corn diseases:

1. Select corn hybrids with resistance or tolerance to major leaf diseases.
2. Select hybrids reported to have good stalk strength.
3. Monitor fields periodically during the growing season for disease development.
4. Consider crop rotation or plowing every few years to help curb the build-up of corn pathogens that could be increasing due to monoculture corn.
5. Seedsmen should not grow inbreds susceptible to leaf disease, or if grown, be prepared to manage leaf diseases with fungicides under reduced tillage systems.

## **Leaf Diseases**

Leaf diseases vary in prevalence and severity from year to year and from one locality to another, depending largely on environmental conditions. Humid weather, along with heavy dew, favors the spread and development of leaf diseases caused by fungi. Leaf diseases can be found on corn grown in poor and rich soils, and soil fertility does not seem to affect these diseases as much as weather conditions, the genetic make-up of a hybrid, and tillage practices used by the grower. Corn leaf disease can be expected when minimum or no-tillage is employed. Growers using overhead irrigation should be more watchful for leaf disease development. Leaf diseases are commonly observed in fields located in valleys between ridges and lowland areas along streams and rivers. These field locations can have prolonged periods of high relative humidity and low or moderate temperatures that favor most leaf diseases of corn. If it is necessary for you to plant blight-susceptible hybrids, restrict their use to upland fields with good air drainage, where corn debris from the previous crop has been thoroughly covered by flowing, or where corn does not follow corn in the rotation.

## **Leaf Disease Control in Seed Production Fields with Fungicides**

The increase in leaf diseases in recent years has necessitated control by use of protectant fungicides for seed producers. Northern leaf spot (NLS), rust, yellow leaf blight (YLB), northern corn leaf blight (NCLB) and eyespot severity can be effectively reduced by foliar fungicide applications. It is rarely economical for commercial corn producers to use fungicides for leaf disease control. However, this is not the case for seed corn producers, because inbreds can be very susceptible to leaf diseases. Early detection is the key for fungicides to be effective.

Should any leaf disease threaten during the period between tasseling and dent (about 35 days), treatment may be economical. It usually is not practical to apply chemicals at earlier or late stages. Early detection is critical; fields of susceptible lines should be monitored on a weekly basis. Chocolate spot, a bacterial disease of occasional severity (where K levels are low), does not respond to fungicide treatment. Severe rust infection developed in certain hybrids and inbreds in recent years. Many inbreds are susceptible to NLS; subsequently, this disease is severe in many seed fields.

If possible, obtain a positive diagnosis of the disorder and consider the factors discussed below before initiating a spray program.

1. The susceptibility of the inbred to the disease or diseases which threaten.
2. The anticipated time of disease developments and severity. Several leaf disease development may occur at any time. Consequently, wet weather or continued heavy dews signal possible blight problems on fields already showing modest leaf spotting. If the blight has already invaded much of the leaf surface above the ear, the treatment benefits will be minimal.
3. Treatments cost versus expected benefit. Each treatment costs about \$15 to \$20 per acre for the chemical, wetting agent, and application, and at least two applications are needed and three or four may be required.
4. Availability of competent commercial applicators and equipment.

# Disease Profiles

---

## Anthracnose



### Causal Organism

Anthracnose of corn is caused by the fungus *Colletotrichum graminicola*. This fungal pathogen infects corn, sorghum, wheat, barley oat, rye, and a large number of grasses. However, strains of *C. graminicola* that infect only one specific crop appear to be commonplace. *Colletotrichum graminicola* is a different species from other *Colletotrichum* species that cause anthracnose of other crops, such as alfalfa and soybean

### Symptoms

Symptoms of anthracnose can appear on leaves, stalks, husks, earshanks, and kernels. Symptoms may appear at various stages of crop development and are influenced by hybrid or inbred susceptibility and the occurrence and duration of warm and humid weather conditions

The leaf disease phase starts as small, oval to elongate water-soaked spots that appear on leaves at any growth stage. Leaf lesions are semi-transparent and may originate on any part of the leaf blade. Spots may enlarge up to 1/4 to 1/2 inch long and become tan at the center with red to yellow-orange borders. Leaf symptoms progress from lower to upper leaves during the growing season and infected leaves wither and die late in the season.

Stalk symptoms may show as a top die-back four to six weeks after silking while lower portions of the plant will remain green. The upper two to three leaves may burn yellow or red and, in time, die and drop off. In some cases, the entire plant may die prematurely and later lodge, although this phase of anthracnose is often expressed later than top die-back.

Anthracnose develops more commonly on the lower sections of the stalk. External stalk symptoms appear after tasseling as narrow, vertical or oval, water-soaked lesions on the rind. Lesions progress from tan to black in color as stalks begin to mature. Lesions are typically shiny black linear streaks or blotches that appear on the lower portion of stalks. Internally, stalk tissues are decayed a dark brown to black color that is most prominent at nodes and progress each direction into the internodes. Stalk strength is reduced because of internal decay. However, pith tissues are not as disintegrated by *C. graminicola* in comparison to *Gibberella* and other stalk rotting fungi. Lodging due to the stalk rot phase of anthracnose is normally higher on the stalk when compared with other stalk rot diseases like *Gibberella* and *Fusarium* stalk rot.

### Disease Cycle and Epidemiology

Stalk rot due to anthracnose has increased in prevalence and severity in Wisconsin corn fields. Anthracnose is no longer considered to be a minor disease in Wisconsin, and farmers and agricultural consultants should be familiar with symptoms and control strategies.

The anthracnose fungus survives in corn leaves and stalks that were diseased in previous years. The pathogen continues to colonize corn debris in the spring and summer. Spores produced on the infested debris are disseminated to corn plants by wind and rain. Spores are produced and germinate most readily during warm and humid weather conditions of leaves and/or stalks. Anthracnose is favored by warm temperatures (70-80°F) and extended periods of cloudy weather and high relative humidity. Frequent rainfall is important for dispersal of the anthracnose fungus. Foliage and stalk wetness are important for infection. Older tissues are more susceptible than younger tissues.

Infection of leaves can occur throughout the seasons, but stalk tissues after tasseling. Stalk rot followed by lodging is the most damaging aspect of ant anthracnose

## Control

Cultural practices such as crop rotation and residue management are important control strategies. The removal, soil incorporation or destruction of infested corn debris will reduce the potential for anthracnose. Tillage systems that leave considerable amounts of anthracnose infected debris on the soil surface may lead to greater severity of anthracnose. Crop rotation to a non-host crop is an alternative management decision.

Corn hybrids differ in susceptibility to anthracnose. Resistance to the leaf blight phase is not always correlated with resistance to the stalk rot phase. Also, resistance or tolerance to other stalk rot diseases is not correlated with resistance to anthracnose.

Selection of resistant hybrids may be more critical for fields where reduced tillage is used because of the greater potential for anthracnose. However, the anthracnose fungus reproduces abundantly and is readily disseminated by wind and rain; thus, anthracnose may develop readily in fields where corn debris from the previous year has been deeply incorporated into the soil.

---

# Northern Corn Leaf Blight



Northern corn leaf blight was a serious leaf disease of corn in the 1950's and 60's. Corn hybrids at that time had little resistance and yields were greatly reduced by this foliar disease. Two forms of resistance were identified (race-specific and field resistance or tolerance) and incorporated into many corn hybrids which resulted in a reduced prevalence and severity of the disease. However, new races of the northern leaf blight fungus have been identified in Illinois, Indiana, Iowa and in Wisconsin. The increased severity observed in 1981 is possibly due to the timely arrival of inoculum, favorable weather conditions, hybrids with less than adequate field resistance (tolerance) and new races that can attack hybrids formerly resistant.

## Causal Organism

*Helminthosporium turcicum* is the fungus responsible for northern corn leaf blight. Three races of the fungus exist, with their virulence depending on presence or absence of specific resistance genes.

Symptoms: Northern corn leaf blight lesions, caused by the fungus *Helminthosporium turcicum*, appear first on the lower leaves of the plant. Spots of either grayish-green or tan in necrotic tissue color are 1 - 7 inches in length and canoe-shaped and approximately 1/2 to 1 1/2 inches in width. The form of resistance, if present, will condition lesion size. Little death of leaf tissues occurs and sporulation of the pathogen is minimal. Under suitable conditions the disease progresses to the upper leaves. Severe infection causes death of foliar tissue that resembles frost or drought with its gray appearance. With the aid of a hand lens, spores can be seen on the necrotic leaf tissue. Ears are not infected, but husks may display lesions. In cases influenced by what is known as HT1 gene condition the lesion takes the form of a long chlorotic linear streak-sometimes the entire length of the leaf.

### **Disease Cycle and Epidemiology**

The fungus overwinters on infested debris of leaves, husks, and other plant parts. It may not survive where winter conditions are especially severe, but conidia (spores) can be wind-borne and transported from corn growing regions south of Wisconsin. Secondary infection occurs from spores produced on the lesions. Spores are spread by wind and rain within a field and from field to field.

Incidence of northern corn leaf blight is found in most humid areas wherever maize is grown. Temperatures from about 65 to 80°F with heavy dews or high relative humidity are optimal for disease development. Northern leaf blight may be more severe in low lying fields along waterways or fields located in deep valleys. Dry weather will retard the advance of the disease. Loss of grain yield up to 50% can occur if the disease becomes established early before silking. Yield losses will be minimal if disease infection is moderate or occurs six weeks after silking.

### **Control**

Two types of resistance are available; single gene resistance (race-specific) and multigenic resistance (field resistance). Inbred lines may greatly differ in resistance or susceptibility. Chemical control may be economical for hybrid seed corn production when the female inbred is particularly susceptible.

Currently, the northern leaf blight fungus is believed not to survive in Wisconsin during the winter months. Thus crop rotation or management of corn debris has little effect on northern leaf blight development. Selection of resistant hybrids is the best control for commercial production.

---

## **Northern Leaf Spot**

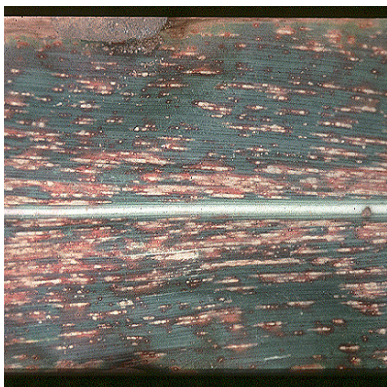

### **Causal Organism**

*Helminthosporium carbonum* is the fungus responsible for this disease.



## Symptoms

This disease is also known as Helminthosporium Leaf Spot. Symptoms on leaves consist of narrow linear lesions 1/16 to 1/8 inch wide and up to 1 inch long, usually consisting of a row of circular lesions, giving a bead-like appearance. The fungus also affects sheaths, husks and ears. The ear can develop a black rot.

## Epidemiology

Its disease cycle is similar to that for the previously discussed diseases; the fungus overwinters in debris or on the ear. Secondary infection occurs with moderate temperatures and high relative humidity. Spore production is abundant in damp weather. At present the severity of the disease has not reached economic proportions. With an increase of conservation tillage, the situation may become problematic. The disease has been a problem in seed production with highly susceptible inbreds.

## Control

Clean plowing and crop rotation will help control the disease. Resistant hybrids exist, but are not well documented and advertised. Chemical control will only be economical for seed producers.

---

# Goss' Bacterial Wilt and Blight

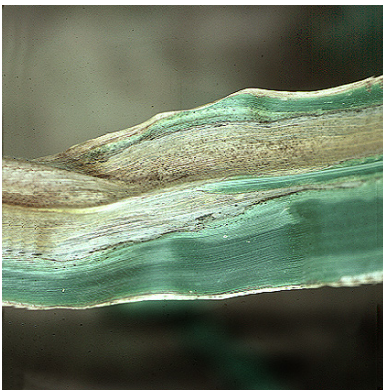

## Causal Organism

*Corynebacterium nebraskense* is the causal bacterium.

## Symptoms

As the common name of the disease indicates, the symptoms of Goss' wilt are expressed both as a wilt and a leaf blight. Lesions may occur on seedlings or older plants. Initial leaf symptoms consist of dark green to silver lesions with dark, water-soaked spots that resemble freckles and run parallel to leaf veins. The water-soaked spots develop into streaks with a greasy appearance. Yellow, grayish-green or purple streaks with irregular margins may also develop. With enlargement of the streaks, bacteria may actually exude from the diseased tissue. The exudate will be sticky when wet, will take on a crystalline appearance when dry, and will glisten in the light. As the streaks coalesce, lesions form and cover much of the leaf surface giving the foliage a scorched appearance.

Systemically infected plants wilt and symptoms resemble those of drought stress. The vascular bundles will be discolored (yellow-brown to orange) and an orange bacterial exudate is extruded from the vascular elements when exposed in cross section. Stalks become weakened and discolored internally with a slimy yellow appearance.



## Epidemiology

Goss' bacterial wilt and blight is a leaf and stalk disease of corn, which was initially reported in Nebraska. Goss' wilt was suspected in Wisconsin in 1980 and was confirmed in southern Wisconsin in 1981. Goss' wilt may reduce yield up to 50% and stalk rot phase may result in lodged stalks. Thus, the disease is considered potentially serious in Wisconsin and fields should be scouted for its presence.

The pathogen overwinters in infested debris on or near the soil surface. The bacterium is seed-borne, but the importance of infected seed is not well documented. Seed-borne inoculum is a means of introducing the bacterium into new areas or fields. Primary infection comes from bacteria that survive in infested corn debris from the previous crop. Wounds are necessary for the bacteria to penetrate the plant tissue. Wind blown sand, hail, pelting rain, and wind can cause abrasions that allow the bacteria to enter and become established within the tissue. Bacteria are spread from plant to plant by wind, driven rain or irrigation water. In addition, the Goss' wilt bacterium may be spread by farm implements that come in contact with diseased plants, especially if plants are wet. Insects are not believed to play a role in disease development. Spread of this bacterium is not completely understood, but it apparently is spread from one geographic area to another through infected seed. Field to field spread probably occurs through movement of infested debris on tillage or harvest equipment.

## Control

The burial of corn debris by deep plowing reduces the primary source of Goss' wilt bacterium. Thus, tillage practices that leave corn debris on the soil surface may lead to greater disease severity once the pathogen is introduced. Crop rotation will also aid in control. However, grass weeds such as foxtail, barnyard grass and shattercane are also hosts and are commonly present in the vicinity of most corn fields. Corn hybrids differ in susceptibility to Goss' wilt. Resistant or less susceptible hybrids should be considered for control of Goss' wilt when it occurs. Consult with your local seed dealer for information on hybrid susceptibility to Goss' wilt.

---

# Gilbberella & Fusarium Stalk Rot



Stalk rot causes substantial losses each year through early plant kill and/or pre-harvest stalk-lodging. It causes premature death of some plants, fermenting or rotting stalks, and discolored pith that weakens the stalk. Stalk rot is caused by a complex of fungal organisms that are particularly damaging to plants subjected to stress during the growing season. High soil moisture in the month of August appears to favor root infection of *Pythium* spp. This fungal infection leads to early plant death and subsequent stalk rot. Small ears and lodging are often the result of the early plant kill phase of the stalk rot disease.

Complete control is difficult for stalk rot, but you can take several steps to reduce the problem; (1) select hybrids that stand the best under your system of farming; (2) maintain a high level of potassium in accordance with soil test recommendations; (3) control leaf diseases, for they cause premature leaf death which leads to greater susceptibility to stalk rot; (4) grow full season corn hybrids where possible,

as early maturing hybrids generally suffer more from stalk rot; (5) harvest as early as practical to prevent greater losses from stalk-lodging; (6) consider other methods of keeping the plant free from stress during the growing season, such as controlling leaf feeding insects and borers, and irrigating during drought conditions where possible. Also, avoid unprofitably high plant populations and excessive applications of nitrogen, as both of these stresses increase stalk rot severity.

The nitrogen stabilizer nitropyrin (N-SERVE) reduces incidence and severity of stalk rot in some tests. If you are considering using N-SERVE, the potential for reduced stalk rot and, subsequently, less stalk-lodging may be another benefit, along with reduced loss of nitrogen through leaching action in the soil.

---

## Ear Rot



Corn is susceptible to several ear-rotting fungi that reduce yield, quality, and feeding value of the grain. Many of these fungi are capable of producing mycotoxins that affect animal health. *Gilberella* and *Fusarium* ear rot are the most common ear rot diseases in Wisconsin. The prevalence and severity of ear rot is associated with: (1) above normal rainfall in July through October; (2) insect feeding on ears; (3) severity of leaf diseases; and (4) hail injury to ear.

### **The following suggestions may help control corn ear rots:**

1. Corn hybrids differ in susceptibility. Ears that are well covered by husks and those that mature in a reclining position have less rot than ears with open husks or those that mature upright. Hybrids that are susceptible to leaf diseases may have more ear rot. Full-season hybrids have fewer ear rot problems compared to early maturing hybrids.
2. Control corn earworms and corn borers where practical.
3. Harvest early.

### **Consider the following strategies when ear rots are prevalent:**

1. Harvest early; the chance of mycotoxin production is less early in the harvest season.
2. Harvest as shelled corn or silage. The fungi associated with ear rots will cease activity in corn lower than 20% moisture content and will not survive activities of fermentation in the silo. Problems will continue if stored as cribbed ear corn.

Many fungi that cause ear rots also produce mycotoxins in the grain that are harmful if fed to livestock. The fungus that causes *Gilberella* ear rot produces mycotoxins that cause reproductive problems in swine. It also produces a mycotoxin called a refusal factor. If the refusal factor is present, swine will not eat the grain.

---

# Seed Rot & Seedling Blights

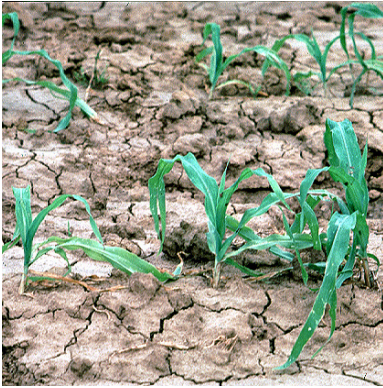

Fungicide seed protectants generally control or minimize seed rot and seedling blights of corn. However, seed rot and seedling blight can be expected if corn is planted in wet and cool soils. Hybrids that have good seedling vigor are generally less susceptible to seed rot and seedling blights. Reduced stands and stunted and/or dying seedlings are the main symptoms to watch for.

Often infected seedlings may develop into a mature plant, but the same disease organism can cause root rot and stalk rot later in the life of a plant. Because injury from herbicides, insecticides, starter fertilizer, and soil insects can cause similar symptoms and results, accurate diagnosis of the problem is important.

---

# Corn Nematodes



Nematodes are microscopic roundworms that reside in many environments including soil. Soil inhabiting nematodes may be parasitic on man, animals, plants or non-parasitic (free-living) and feed on organic matter or soil microorganisms.

Plant parasitic nematodes obtain nutrients by feeding of living plant tissues, usually roots. Species of plant parasitic nematodes can feed on a wide range of plants or can be very host specific. Plant-parasitic nematodes obtain nutrients by feeding off living plant tissues, usually roots. Species of plant parasitic nematodes can feed on a wide range of plants or can be very host specific. Plant-parasitic nematodes lower plant productivity by extracting nutrients from the plant, disrupting nutrient and water uptake by roots, root structure is disrupted by the physical presence of the nematodes, and nematode feeding provides wounds for other disease organisms to enter roots and cause decay.



Nematodes reproduce by eggs. The eggs hatch and three larval stages are present before developing into mature adults. The life cycle, from egg to egg may be completed in 3 to 4 weeks depending on environmental conditions, susceptibility of the host and nematode species.

## **Nematodes Associated with Corn**

The lesion (*Pratylenchus*), needle (*Longidorus*), stunt (*Tylenchorynchus*), stubby root (*Trichodorus*), Lance (*Hoplolaimus*), and dagger (*Xiphinema*) nematodes have been found to be associated with corn in Wisconsin. Every cornfield in Wisconsin may be infested with one or more of these types of nematodes, but not all fields have populations that may reduce yield.

Soil and root assays have revealed nematode populations capable of reducing corn yields 5-35 bushels/acre in Wisconsin. There seems to be some relationship with soil types. More economic problems with nematodes have been observed on sandy compared to clay soils. Crop rotation does not appear to have much effect on soil populations of the lesion, stunt, lance, and dagger nematodes because they infect many other crops besides corn.

There are indications that higher nematode populations build-up in reduced tillage fields compared to fields tilled with a moldboard plow. Moldboard plowing brings roots to the surface, exposing them to the elements and also diluting the nematode populations throughout the soil profile.

## **Symptoms of Nematode Injury**

Because of the nonspecific nature of above-ground symptoms, plant damage by nematodes is often blamed on weather, local soil conditions, nutritional deficiencies, injury by agricultural chemicals, insects or other disease causing organisms. In addition, plant symptoms associated with low-level yield losses are often not visible unless concentrated in one part of the field. In such cases, the only visible symptom is the lower-than-expected yield of the field. Nematodes do not kill plants except in very unusual circumstances. Above ground symptoms are usually due to nematode injury to the roots.

## **Early Season Above-Ground Symptoms**

1. Look for irregular areas of stunted corn. Patches may involve a few square yards up to several acres.
2. Nutrient deficiency symptoms such as phosphorus (purple leaves) manganese or zinc (leaf stripings) may be the result of nematode feeding.
3. Height variation can be seen when plants are waist high to tasseling. Nematode damaged areas may tassel a few days later than healthy plants.

## **Late Season Above-Ground Symptoms**

1. Later in the season, nitrogen and potassium deficiency symptoms may appear.
2. Curling of the leaves, associated with drought stress, often will occur during hot afternoons and is one of the most common nematode symptoms on lighter soils.
3. Other above-ground symptoms to look for include small ears with poor grain fill and low yields over the entire field or in the localized areas in the field.
4. Stall lodging or stalk rot may be associated with nematode damage.
5. In general, nematode feeding may enhance the effects of medium to low soil fertility, low soil moisture, soil compaction, and other non-living causes of poor plant growth. Plants can tolerate nematode feeding if the conditions are optimal for plant growth.

## **Root Symptoms**

Normally, the root mass of a corn plant is fan or broom shaped in cross section, with many fibrous secondary roots off the main roots.

## Root injury caused by nematodes:

1. Stubbing of roots, numerous short and stubby roots, often arranged in clusters. Root injury by dinitroaniline herbicides can cause a similar symptom.
  2. Few fine feeder roots. Fine feeders are necrotic.
  3. Smooth sections of main roots, few feeder roots, possible root lesions and rotted sections of roots.
- Root damage by corn rootworms may also be involved from June until the crop matures. Damage by rootworm larvae is identified as grooves or tunnels, either on the surface or within the root. Nematodes never leave visible feeding areas that give the appearance the tissues have been consumed.
- Nematode damage often is related to the growing conditions of the plant. A corn plant that is stressed by poor fertility or lack of moisture cannot withstand an additional stress of nematode feeding. Plants growing with adequate moisture and fertilizer are more likely to compensate for nematode feeding by producing new roots. However, when the nematode population is too high, even vigorously-growing plants will eventually show symptoms of unthriftiness.

## Sampling for Corn Nematodes

A nematode assay can be used in two ways: 1) to confirm a suspected nematodes problem or 2) to eliminate nematodes as one of several possible causes of poor plant growth.

The best results are obtained when soil and root samples are taken 6 to 10 weeks after planting. Nematode populations at this time appear to correlate best with grain yield. However, late summer or fall samples can also be useful in predicting next year's problems.

Nematode damage to corn often appears in circular or oval pockets in the field. Rarely does an entire field show symptoms. Sample the suspected areas.

There are several ways to take a soil sample for nematode analysis. The following is a general guide.

1. Use a soil probe or narrow-bladed trowel or shovel. Take samples close to plants and to a depth of 8 to 10 inches. Discard the upper 2 inches of soil, especially if it is dry. Be sure to include plant roots.
2. One sample is adequate per 10 acre field or suspected area within the field. Sample soil and roots from 10 plants and mix into one composite sample-2 pints of soil is adequate. Sample from plants in the margins of suspected areas and not from their centers.
3. Place samples in sturdy plastic bags and fasten the open end securely and accurately label samples. Keep the samples from becoming overheated. Mail samples early in the week to avoid delays in transit.

## Interpreting Results of Nematode Soil Analysis

Laboratories will report the number of nematodes per pint of soil (500 cc), per 100 cc of soil, or nematodes per gram of dry root. Each laboratory has its own damage thresholds for individual nematode species. However, each laboratory will give an assessment regarding the possibility of economic damage .

Corn growers can utilize reports on soil and root test and field strip tests using effective nematicides compared to no treatment to determine if nematodes are reducing corn yields on their farms. If rootworms are present in a field, a strip test should include an effective insecticide/nematicide compared to a product that gives only rootworm control, but not nematode control.

Factors that influence economic thresholds for plant-parasitic nematodes are time of year or stage of crop development when the sample was taken and soil type.

## Corn Nematode Control

If economic populations of nematodes are detected, corn growers can employ these control recommendations.

1. Chemical control: Several insecticides/nematicides are registered for nematode control on corn. Mocap 20G, and Counter 15G are registered for nematode control on corn. Follow the label for rate



and method of application. Many corn rootworm insecticides are effective against rootworms but not nematodes.

2. Maintain high soil fertility. Nutrient deficient plants are more susceptible to nematode injury.
3. Crop rotation may be of value, but little is known about the susceptibility of other crops.
4. Practice good weed control. Many weeds are good hosts for corn nematodes and will help maintain or even increase nematode populations.

---

## Gray Leaf Spot

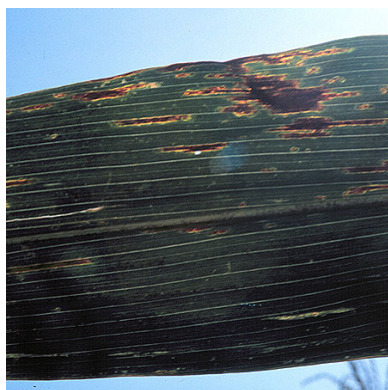

### Causal Organism

*Cercospora zea-maydis* and *Cercospora sorghi* var. *maydis* are two closely related fungi that can cause gray leaf spot. *C. zea-maydis* is the more common cause of the disease in the USA.

### Symptoms:

In contrast to most leaf spots that have circular or ellipsoidal lesions, lesions of gray leaf spot tend to be long (3/16 to 2 inches) and rectangular, and are typically restricted by veins of the leaf. Lesions are pale brown, gray or tan, and are opaque. When the disease is severe, individual lesions may merge, the entire leaf may die and total defoliation of the plant is possible. Weakening of plants due to gray leaf spot may result in lodging.

### Epidemiology:

The disease cycle of gray leaf spot is similar to those of other corn leaf spot diseases. The fungus overwinters in corn debris and thus the disease tends to be most prevalent where continuous corn is produced and no-till practices are used. The causal fungus tends to be favored by higher temperatures and thus gray leaf spot is more common in the southern USA. However, reports of the disease have recently increased in the upper mid-west, perhaps due to the increased use of no-till practices.

### Control:

Clean plowing and crop rotation will help control this disease. Resistant hybrids are available and should be used when available and the potential for the disease is high. Chemical control is also possible, although likely only to be economical for seed corn production.

## Contents

Chapter 4: Soybeans . . . . .	1
Quick Reference Photos. . . . .	2
Insect Profiles . . . . .	3
Bean Leaf Beetle . . . . .	3
Grasshoppers . . . . .	5
Green Cloverworm . . . . .	6
Japanese Beetle. . . . .	7
Seedcorn Maggot . . . . .	8
Soybean Aphid . . . . .	10
Two Spotted Spider Mite . . . . .	13
Woolly Bear Caterpillar. . . . .	15
Quick Reference Photos. . . . .	16
Soybean Disease Management. . . . .	17
Fungicides. . . . .	18
Pythium Seed Rot . . . . .	20
Rhizoctonia Seed Rot and Seedling Blight . . . . .	20
Phytophthora Seed Rot and Seedling Blight . . . . .	20
Phomopsis Seed Rot . . . . .	21
Phytophthora Stem and Root Rot . . . . .	21
Brown Stem Rot . . . . .	24
Sclerotinia Stem Rot. . . . .	25
Soybean Cyst Nematode . . . . .	26
Soybean Virus Diseases . . . . .	30

# Quick Reference Photos

## Soybean Insects



Bean Leaf Beetle



Grasshopper



Green Cloverworm  
*and Damage*



Japanese Beetle



Japanese Beetle  
*Injury*



Seed Corn Maggot  
*Injury*



Soybean Aphid



Winged Soybean Aphid

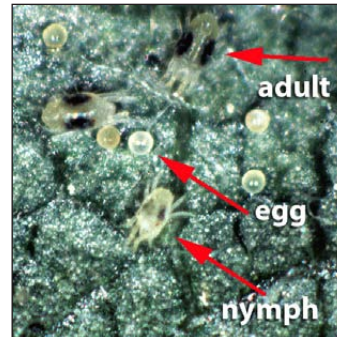

Two-Spotted Spider Mite



Woolly Bear Caterpillar

# Insect Profiles

---

## Bean Leaf Beetle



### Description

The bean leaf beetle is an insect that feeds primarily on soybeans. Damage is likely to occur in growing seasons that follow mild winters. The adult is  $\frac{1}{4}$  inch long, has various colorations and arrangements of black spots on its wing covers. Pale-yellow is the most common color. Other variations include tan, green and crimson. All adults will have a black triangle behind the thorax (neck region). Some will have no other markings; others will have a series of black dots (usually 2-4) and a black line around the outer edge of the wing covers. Larvae, which are found on roots of soybean, are white and distinctively segmented, with brown heads and a brown hardened area at the posterior end of the body.

### Life cycle

Bean leaf beetles overwinter as adults under plant debris in woodlots and fencerows near soybean fields. Adults become active in the spring when temperatures reach 50-55 °F. In Wisconsin, this activity usually begins mid-April, well in advance of soybean planting. These overwintered adults feed on alternate hosts such as clover and alfalfa, and then move to emerging soybeans to feed and lay eggs. Larvae feed on soybean roots and nodules. The first generation of bean leaf beetles takes about 50 days to complete, and adults begin to emerge in late June or early July. These adults also feed on foliage and lay eggs in the soil at the bases of plants. Second generation adult emergence occurs during the latter part of August or early September.

### Damage

The overwintering adults attack emerging seedlings and feed on cotyledons and leaves. First generation adults feed only on leaves. Defoliation from the overwintering and first generation adults can reach the economic threshold in Wisconsin; however, this is not common. Second generation adults will also feed on leaves but also attack pods as the leaves begin to senesce. This pod feeding can cause wrinkled seeds and it creates pathways for invasion by fungal spores which cause the seed to mold or discolor. Young larvae feed on the root hairs; as larvae mature they will begin to attack the nitrogen fixing nodules. It is not known if feeding damage by the larvae significantly affects yield. Bean leaf beetles also damage soybean plants by transmitting bean pod mottle virus (BPMV). Although bean leaf beetles transmit BPMV all season long, transmission during early vegetative stages of soybean development

is regarded as most important to yield loss potential. Thus, critical virus transmission is occurring at a time the bean leaf beetle itself is not regarded as important unless at extremely high levels that kill seedlings. Research data suggests that BPMV can cause yield loss in the 5-10 bu/acre range. Growers who have experienced 10-50% mottled seed at harvest most likely have local sources of BPMV inoculum and their fields and are at risk if moderate to high populations of bean leaf beetle are observed in May and June.

### **Scouting suggestions**

Direct observation is the preferred method of monitoring bean leaf beetles during the seedling stage. Bean Leaf Beetle activity can vary according to time of day, as a result, mid morning to midday are preferred. Windy conditions as well as low or high temperature can also affect beetle activity. Slightest disturbances will also cause the beetle to drop to the soil and remain motionless for a considerable length of time. After the soybeans are too large for direct observations, use the drop cloth technique (for wide row soybeans only) or 15 inch diameter insect sweep net. Take a minimum of 20 consecutive sweeps in each of five areas of a field.

### **Economic thresholds**

There are two approaches to manage the bean leaf beetle and/or BPMV. When BPMV is a significant problem it requires different management practices than if the concern is over defoliation only.

### **Management for Defoliation only**

Consult UW Extension Bulletin "Pest Management if Wisconsin Field Crops" A3646 for control recommendations. This bulletin maybe purchased from your local county extension office or is available to view, purchase or download from UW Cooperative Extension's The Learning Store at <http://learningstore.uwex.edu/>

For early season damage, count beetles per plant and compare counts with growth stage, crop value and treatment costs. For reproductive stage soybeans count beetles/row foot or beetles/sweep and compare with treatment costs and crop value.

### **Management to prevent transmission of Bean Pod Mottle Virus**

Soybean varieties that are resistant to BPMV have not yet been identified, although anecdotal evidence suggests that varieties differ in their susceptibility. Additionally, growers should avoid early planting if BPMV is expected to be a problem in their area. Early planting often attracts high beetle populations and increases the chance of transmitting BPMV.

If virus symptoms (leaf mottling, discolored seed, green stem and/or unexplained yield loss) were high the previous year, then beetles must be managed using a completely different approach. That is, economic thresholds mentioned above are not effective because beetles must be killed prior to significant defoliation. To prevent transmission of BPMV, an insecticide application must be made in the very early stages (VC-V1) of soybean development. A second application may be necessary during the emergence of first generation beetles in late June or early July. Delayed spraying at either crop stage can seriously increase incidence of BPMV.



---

# Grasshoppers



## Description

Numerous species of grasshopper adults and nymphs feed on soybean.

## Life cycle

Pest species overwinter in an egg pod located in the soil, near the surface. The species common to soybeans deposit eggs in fencerows or other undisturbed areas near soybean fields. The nymphs will begin to feed in these areas but if the vegetation is consumed or becomes dry, the grasshoppers will move to soybeans. The adult stage is reached in August and the eggs will be laid during September.

## Damage

Adults and nymphs will defoliate soybeans. Although damage is normally confined to the border rows, it will become widely scattered over the field as the season progresses. Damage may be more widespread in dry growing seasons.

## Scouting suggestions

Damage normally will peak in August. Sample plants in several areas of the field and note the degree of defoliation.

## Economic thresholds

Control is suggested if defoliation reaches 30% prior to the bloom stage, or if it reaches 20% between blooming and pod-filling stages.

## Control

Consult UW Extension Bulletin "Pest Management if Wisconsin Field Crops" A3646 for control recommendations. This bulletin may be purchased from your local county extension office or is available to view, purchase or download from UW Cooperative Extension's The Learning Store at <http://learningstore.uwex.edu/>

---

# Green Cloverworm



## Description

Although many green, legume-feeding caterpillars can be found in our soybean fields, the green cloverworm is the only species believed to be a potential threat. It can be found in Wisconsin at low levels, but in states like Iowa, Illinois, and Indiana, a few large outbreaks have occurred. During most years a fungal disease is a key factor in keeping populations at subeconomic levels.

The green cloverworm is light green and has two thin white stripes along each side of the body. They have only four pair of fleshy abdominal prolegs (including anal prolegs). As is true with the other caterpillars. There are three pairs of “true” legs just behind the head. When fully grown they are approximately 1 to 1-1/2 inches long. They are quite active, falling to the ground at the slightest disturbance. Adults are nondescript, dark brown and black moths that, when at rest, are triangular in shape.

## Life cycle

The overwintering stage of the green cloverworm has not been detected in Wisconsin but it probably overwinters as a pupa in the soil. Moths appear in the spring and oviposit on alfalfa and clover. Moths of the next generation continue to deposit eggs on alfalfa and clover but some place eggs on soybeans beginning in June or July. More eggs occur on soybeans as the plants start to form pods. Eggs take about five days to hatch and larvae feed on foliage for three weeks. Three to four generations occur each year.

## Damage

Green cloverworms cause defoliation of plants. When populations are heavy, they may attack the soybean pods. Defoliation that occurs during the pod-set and -filling stages reduces yield to a greater extent than defoliation which occurs during vegetative growth stage.

## Scouting suggestions

Detailed scouting is not necessary until leaf feeding is detected. When this occurs vigorously shake several consecutive plants within a row and then examine the soil surface for the presence of the larvae. Do this in several areas of the field and record the number of larvae per foot of row. Also note the growth stage classification for the soybean plants in the field.

## Economic threshold

Control is suggested if defoliation occurs during blooming, pod set, or pod fill. This usually requires 12 or more half-grown worms per foot of row and 15-20% defoliation to justify treatment.

## Control

Consult UW Extension Bulletin “Pest Management if Wisconsin Field Crops” A3646 for control recommendations. This bulletin may be purchased from your local county extension office or is available to view, purchase or download from UW Cooperative Extension’s The Learning Store at <http://learningstore.uwex.edu/>

---

# Japanese Beetle



Scientific Name: *Popillae japonica*  
Order: Coleoptera  
Family: Scarabeidae

## Description

Adults are approximately 3/8 inch long, metallic green with bronzed wing covers. Six white spots are found on each side near the tip of their abdomen. Immature grubs are C-shaped, up to 3/4 inch long and white in color.

## Life Cycle

Japanese Beetles complete one generation/year. They overwinter in the soil as third instar grubs and can be found in grassy areas. Adults emerge in mid to late June and peak feeding activity is in mid-July. Adults remain active through late summer.

## Damage/Symptoms

Japanese Beetles were introduced into the United States in 1916. They have adapted to colder winter climates and have recently expanded their range into Wisconsin. The adult beetle feeds on over 300 plant species. Defoliation can be extensive. Immature grubs damage roots of cool season turfgrasses and ornamentals. Their feeding can severely damage or kill plants.

Grubs do little or no damage to soybean. Defoliation to soybean by adults is usually light in Wisconsin. However, severe defoliation may be locally heavy or spotty within a field. Defoliation is often described as “lacy” or “net like” in appearance. Treatment decisions are often complicated because of the presence of other soybean defoliators, including green cloverworm, grasshoppers, bean leaf beetles and wooly bear caterpillars.

## Scouting Procedure and Economic Threshold

Spot check soybean fields for defoliation when adults become active. Adults may congregate in areas of the field making spot treatments feasible. Damage may also be mixed with other insect defoliators. Treat vegetative soybean at 30% defoliation and reproductive stage soybean at 20% defoliation.

## Non-chemical control

Several non-chemical controls are available for grubs in urban settings. However, these practices have been inconsistent and are not recommended in soybean production.

## Chemical Control

Several insecticides have demonstrated effectiveness for control of Japanese beetles. Timing of application is critical and should be coupled with field scouting activities to achieve effective and economical control. Consult UW Extension Bulletin "Pest Management of Wisconsin Field Crops" A3646 for insecticide control recommendations. This bulletin may be purchased from your local county extension office or is available to view, purchase or download from UW Cooperative Extension's The Learning Store at <http://learningstore.uwex.edu/>

---

# Seedcorn Maggot



## Description

The maggot is a white, tapered, legless larva that will be found in or near the planted seed. After feeding, the maggot forms a brown capsule-like puparium in which it pupates. Puparia are commonly seen in the soil next to the crop row. The adult is a fly about one-half the size of an adult housefly. They can be found on the soil surface during late spring whenever the ground is disturbed, such as during tillage and planting.

## Life cycle

This species passes the winter in a brown puparium located in the soil. Adults emerge in late spring about the time soybeans are being planted. Eggs will be laid in any field with an abundance of organic matter. Decaying weeds and crop residue, or application of livestock manure will make a field more attractive to the egg-laying flies. Freshly tilled fields are also attractive egg-laying sites. Eggs hatch in approximately four days and the young larva moves about in the soil in search of food. This stage lasts about 12 days at a soil temperature of 70°F. After pupal development (approximately 15 days), adults will appear and start another generation. There are several generations per year.

## Damage

The maggot burrows into the germinating seed and even one larva per seed may kill the soybean seed. If the seed germinates, maggots will feed in and on the cotyledons. When these plant parts ap-

pear above ground they will have brown feeding scars. Occasionally a shoot will emerge and cotyledons will be absent - such plants are occasionally referred to as “snakeheads”.

Anything that delays emergence, such as dry topsoil or cold, wet weather will increase the chance of damage because the plants take longer to emerge and allow more time for egg hatch and feeding injury.

### **Scouting suggestions**

There are no scouting methods available to assist with the identification of fields that are likely to have economic damage. However, forecasting appearance of adults can be accomplished through the use of degree days. Begin calculating and accumulating degrees in early spring as the ground thaws. Seedcorn maggots have a base developmental temperature of 39°F, therefore, the formula for daily degree day accumulation is  $(\text{daily high} + \text{daily low})/2 - 39$ . Adult peak activity can be expected at 200, 600 and 1000 accumulated degree days. Additionally, the use of yellow dishpan traps can be helpful in confirming adult flight periods and are especially useful when coupled with degree day accumulations. Distribute several (3-4) yellow dishpans filled with soapy water around the perimeter of a field. These yellow dishpan traps serve as a visual attractant. Count adults every 2-4 days to determine if adult populations are increasing or declining.

### **Economic thresholds**

There are no rescue treatments for the crop once damage is present. If an emerging field of soybeans has a spotty stand, seed maggot feeding injury must be considered as one of many possible causes which includes mechanical (planter or drill, crusting, disease, etc) problems. It is important to verify the cause so corrective action may be taken in the future.

### **Cultural Control**

All best crop management recommendations must be considered and prioritized. However, if seedcorn maggots are a primary concern, avoid planting until soil temperatures are, or will be, warm enough to ensure rapid emergence. Avoid planting in freshly tilled fields and/or fields with significant accumulations of green or livestock manure.

### **Natural Control**

A naturally occurring fungal pathogen will cause high adult mortality when relative humidity is high. Additionally, several species of ground beetles will prey on eggs, larvae and pupae.

### **Chemical Control**

Rescue treatments for control of seedcorn maggots are ineffective. However, several seed treatments are available. Consult UW Extension Bulletin “Pest Management if Wisconsin Field Crops” A3646 for insecticide control recommendations. This bulletin maybe purchased from your local county extension office or is available to view, purchase or download from UW Cooperative Extension’s The Learning Store at <http://learningstore.uwex.edu/>



---

# Soybean Aphid

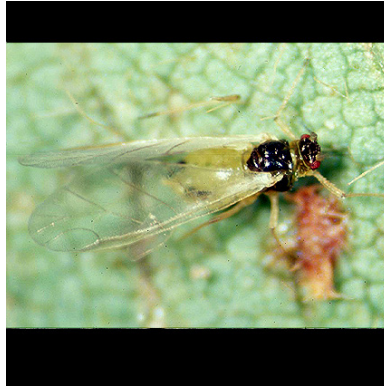

## Description

Soybean aphids are small (approximately 1/16 inch long) soft-bodied insects, and may be winged or wingless. They are light yellow in color and are usually concentrated on leaves, petioles and stems at the top of the plant during the early part of the growing season. Winged adults will have a black head and thorax. A life stage called “white dwarfs” are produced in mid-summer in response to either temperature, day length and/or crop nutrition. White dwarfs are smaller, cream to whitish in color. They do not live as long nor reproduce as quickly as the yellowish soybean aphids.

## Life Cycle

Buckthorn (*Rhamnus* spp.) is the only known overwintering host. As is true of other aphids in the temperate zones, the soybean aphid can only survive the winter in the egg stage. The egg is very winter hardy and can survive prolonged periods of low temperatures. Soybean aphids will hatch in the spring and go through two to three generations of wingless females before a winged generation leaves buckthorn in search of soybean. Numerous generations of winged and wingless females will develop on soybeans before winged females migrate back to buckthorn in late-summer/early fall to mate and lay eggs.

## Damage

Soybean aphids cause damage by sucking plant sap and may transmit viruses during the feeding process. Symptoms of direct feeding damage may include plant stunting, reduced pod and seed counts, puckering and yellowing of leaves. Various plant stresses, including nutrient deficiencies, may intensify these symptoms. Soybean aphids also excrete a sugary substance called honeydew while they are feeding. When aphid populations are heavy, the plants could be coated with honeydew which may turn black as a result of sooty mold growth on the honeydew. This can reduce photosynthesis and contribute to yield loss.

Additionally, soybean aphids are capable of transmitting viruses, including alfalfa mosaic virus (AMV) and soybean mosaic virus (SMV). These viruses commonly occur together and form a complex. Although plants may be infected early in the season, foliar symptoms caused by viruses usually are most apparent by late vegetative or early reproductive stages. Symptoms are frequently associated with specific fields and not all fields in a region. Symptomatic plants are associated with reduced plant populations, slow developing crop canopies or late planted fields. The incidence of symptomatic plants commonly progresses inward from edges of fields. Symptoms may also be distributed in fields either as single plants or clusters of plants. The pattern of symptomatic plants in the field is dependent on specific viruses present and aphid activity. General symptoms caused by soybean viruses include plant stunting, leaf distortion and mottling, reduce pod numbers and seed discoloration. Infected seed is the most

important means for introducing soybean mosaic virus into a field. Seed-borne inoculum, however, is a less significant source of inoculum for alfalfa mosaic virus. Seed transmission is extremely important for soybean mosaic virus because the virus is seldom found in plants other than soybean, thus there is low probability that aphid vectors will acquire this virus outside a soybean field.

Forage legumes are important sources of inoculum for alfalfa mosaic virus. Therefore, soybean aphids will acquire this virus from other legumes prior to migrating into soybean fields. Evidence is mounting that soybean viruses are becoming more important in the North Central States. It is not possible to prevent spread of these viruses by using insecticides to control aphids. Research is needed to determine specific symptoms caused by each virus, the extent of yield and seed quality loss caused by each virus and management practices to reduce risks associated with the insect-virus complex.

## Scouting Suggestions

Start spot-checking soybeans for soybean aphids in mid-June and continue to estimate aphid numbers at weekly intervals until aphid populations decline. This may be late August. Soybean aphids are usually found on the underside of newly developing leaves. Later in the growing season soybean aphids may be found on all leaves within the plant canopy. Initially, field distribution of soybean aphid will be spotty and they will be difficult to find. As the growing season progresses, aphid populations will be more randomly distributed throughout the field. Early soybean reproductive stages (V1-V4) have typically been the periods for the most rapid aphid population increases, and the time when scouting is most critical. A minimum of two field visits are required to determine if aphid populations are increasing. To calculate a field average, count the number of aphids on 20-30 plants/field.

Soybean aphids have numerous natural enemies. When estimating aphid populations, it would be important to estimate beneficial insect populations at the same time. Comparing population trends of natural enemies with that of the soybean aphid can help in determining control needs. For example, if aphid populations are not increasing from one scouting visit to the next and lady beetle populations are increasing rapidly you may decide to delay, if not eliminate, the need for an insecticide application.

## Economic Threshold:

Crop Stage	Economic Threshold
Emergence to mid-vegetative	Economic benefit from insecticide application is unlikely.
Late-vegetative to R4 (3/4 inch pod)	Treat when 80% of the field average has reached an average of 250 aphids/plant and the populations are actively increasing
Beginning seed (R5)	Thresholds at this crop stage have not been established However, actively increasing populations greater than 250 aphids/plant may require treatment.
Full Seed (R6) to Maturity (R8)	Economic benefit from insecticide application is very unlikely.

## Natural control

Lady beetles, insect pathogens, lacewings, syrphid flies, etc., appears to be helpful in control of soybean aphids. Trends in aphid populations should be considered when determining the need for control.

## Chemical control

Several insecticides are labeled for soybean aphid control on soybean. Consult UW Extension Bulletin "Pest Management if Wisconsin Field Crops" A3646 for control recommendations. This bulletin maybe purchased from your local county extension office or is available to view, purchase or download from UW Cooperative Extension's The Learning Store at <http://learningstore.uwex.edu/>

# Soybean Defoliation Guide



---

# Two Spotted Spider Mite

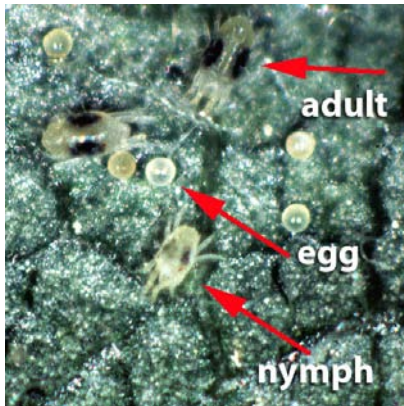

## Description

As the name implies, this pest is a mite and not an insect. Adults are minute ( $< .02$  inch), yellow-green, have eight legs, and feeding stages have dark pigmented spots on either side of their oval bodies. The adult female is globular and slightly larger than the male. The male's body is pointed at the hind end and has longer legs than the female. Eggs and immatures are also yellow-green; there are six- and eight-legged immature stages. When adult mites prepare to diapause (stage of arrested physiological development), individuals are produced that are orange to red in color and slightly larger than non-diapausing mites.

The mites resemble tiny spiders and will spin webbing (hence the name spider mite) and the small round eggs will be found on the leaf surface or within the webbing. Under heavy infestations, plants may be completely covered with webbing. If mites need to move to another area because of a diminishing food supply or other undesirable situations, they will climb to the top of the plant and spin tiny strands of silk that, when caught by breezes, will allow the mite to drift to new host plants. This process is called "ballooning".

## Life cycle

The two spotted mite overwinters as fertilized females in the loose soil and plant debris at or near the soil surface. After temperatures start to warm in the spring, the overwintering females seek out growing plants and begin to lay eggs. These eggs, and those of subsequent generations are clear to pale in color, oval and less than 0.01 inch in diameter. Eggs hatch into the six-legged immature stage called a larva which, other than the number of legs, looks very similar to the subsequent immature and adult stages. After some feeding and growth, the larva molts its skin and transforms into the slightly larger eight-legged protonymph. An additional molt occurs to the deutonymph stage, also eight-legged. Finally, the immatures molt one last time to the adult reproductive male and female stages.

## Damage

Significant damage occurs during years in which soybean plants undergo severe moisture stress for several days. Damage usually starts at field edges where mites have moved into soybean fields from adjacent grasses and weeds. Dry weather, low humidity, and stressed plants provide optimal conditions for mite reproduction and development.

Spider mites feed by penetrating the plant tissue with sharp stylets (specialized structures associated with piercing mouthparts) and removing cell contents. The chloroplasts disappear and the small remaining cellular material coagulates to form an amber mass. Farmers often mistakenly blame spider mite injury on drought. The water balance of mite-damaged leaves is disturbed, water loss through transpiration is increased, and this will eventually lead to drying out, bronzing, and dropping of leaves. This leaf

damage reduces the plant's ability to manufacture plant food through the process of photosynthesis, which in turn reduces the plant's grain filling capability.

The damage first appears as white flecks from feeding by the colonies, which are located on the undersides of leaves. This condition is called "stippling". Eventually this condition will become worse and leaves will appear bronze, and in some varieties necrotic lesions will occur. Under heavy infestations the plants will even shed leaves.

## **Scouting**

Spider mite outbreaks typically occur during periods of hot, dry weather. Begin spot checking field edges looking for early signs of stippling. Use a hand lens to look for mites or hold a white sheet of paper under a leaf while tapping it. Dislodged spider mites will fall on to the white paper and more easily recognized.

## **Economic thresholds**

Treatments based on spider mite number/leaf or plants have not been established. Treatment is suggested if the majority of plants are infested with mites and stippling is evident, even on healthy green leaves. Especially, if eggs, nymphs and adults are found. Plants may still respond to treatment if they are heavily infested and leaves are discolored and wilted. Under extreme mite infestations (fields are discolored, leaves are bronzed and/or dropped) treatments may not be economical.

## **Natural Control**

A fungal pathogen may be an effective control when temperatures are cool and relative humidity high for 12-24 hours. Infected mites will be discolored 1.-3 days after infection.

## **Chemical Control**

Several insecticides/miticides are available for control of two spotted spider mites. Continue to monitor fields after application and after the Reentry Interval has passed, to verify control. Look for active colonies of adults, nymphs and or eggs. Consult UW Extension Bulletin "Pest Management if Wisconsin Field Crops" A3646 for control recommendations. This bulletin maybe purchased from your local county extension office or is available to view, purchase or download from UW Cooperative Extension's The Learning Store at <http://learningstore.uwex.edu/>

|



---

# Woolly Bear Caterpillar



## Description

Although an occasional pest in neighboring states, the woollybear complex has not reached economically important populations in Wisconsin. These larvae are in a rather large insect family that is also referred to as tiger moths because of the colors and color patterns of the adult stage. Larvae are robust and hairy; hence the name woolly bears, and may be white, reddish brown, black, yellow, or black at the head and anal ends and separated by a reddish brown band in the middle of the body. When fully grown they are approximately two inches long.

## Life cycle

Depending upon the species, overwintering is either accomplished in the larval or pupal stages. In the spring adults lay eggs in spherical patches on leaves and often cover the egg masses with hairs from their bodies. Young larvae usually feed in clusters on the bottom surface of leaves; as they grow larger they will lose this gregarious habit and feed in more exposed locations. There are two generations per year.

## Damage

These caterpillars are leaf feeders that, when present in large enough numbers, are a potential threat to soybean production.

## Scouting suggestions

Sample plants in several areas of the field and note the size of larvae, percent defoliation, and stage of soybean development.

## Economic threshold

When defoliation reaches 30% before bloom or 20% between bloom and pod fill.

# Quick Reference Photos

## Soybean Diseases



Pythium Seed Rot

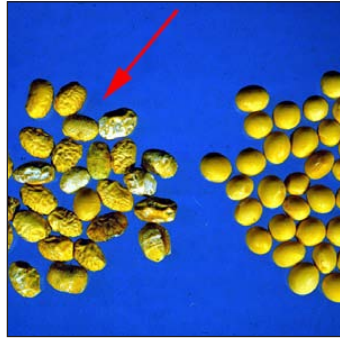

Phomopsis Seed Rot



Phytophthora Stem and Root Rot



Sclerotinia Stem Rot

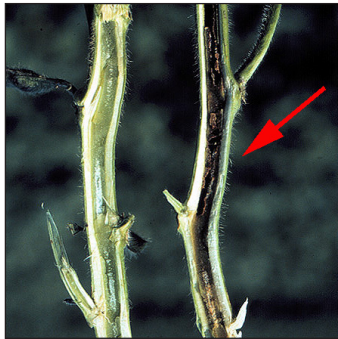

Brown Stem Rot



Brown Stem Rot leaves

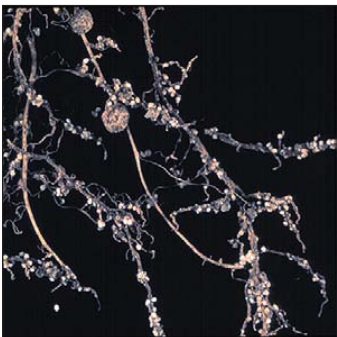

Soybean Cyst Nematode

## General Soybean Virus Symptoms



Mottling/Mosaic Leaf Symptoms

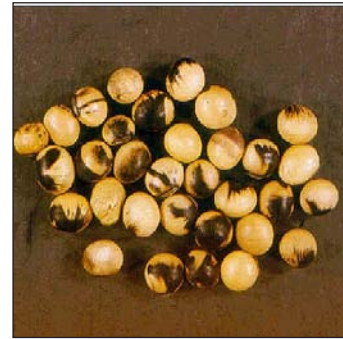

Bleeding Hilum



Green Stem



Discolored Pods

# Soybean Disease Management

Dr. Craig Grau, Department of Plant Pathology' University of Wisconsin-Madison

Soybeans grown in Wisconsin are subject to attack by several disease-causing organisms. Growers, scouts and crop advisors should learn to identify the major soybean diseases in order to distinguish them from poor plant health due to insects, adverse weather, herbicide injury, and nutrient deficiencies. Solutions to disease problems are generally quite different compared to correcting plant disorders due to insects, weeds, and other agents. Soybean diseases can be prevented or reduced by proper use of resistant or tolerant varieties, correct cultural practices, and fungicides or nematicides.

## Resistant or Tolerant Varieties

The use of disease resistant or tolerant varieties is a practical and economical control for soybean diseases in Wisconsin. However, there is not one variety resistant to all diseases. Carefully evaluate the major diseases on your farm and consider disease reactions when selecting soybean varieties you wish to plant. Disease reaction of soybean varieties can differ from year to year because the microorganisms that cause plant disease can change genetically and attack varieties that were formerly resistant. Soybean varieties may also have different reactions when grown under different cultural practices and weather conditions.

## Crop Management

The use of crop rotation and clean tillage are very powerful disease control tools. The roles of crop rotation and clean plowdown are more important with soybeans than with corn because disease resistance to many important diseases is not available in soybeans. Many of the important fungal and bacterial diseases of soybeans survive between cropping seasons on and in crop debris. Once this crop residue is thoroughly decayed, these disease-causing organisms die out. Therefore, crop rotation and tillage programs that permit residue decomposition before the next crop is planted will help reduce diseases such as brown stem rot, pod and stem blight, anthracnose, stem canker, Septoria brown spot, Cercospora leaf spot (purple seed stain), bacterial blight, and several other fungal and bacterial leaf diseases.

Production of soybeans with practices which do not allow for soybean debris decomposition may result in severe disease losses. Diseases causing organisms that are normally considered minor can build up and cause severe losses under such conditions. Growers should weigh the benefits of deep-plowing to reduce diseases versus minimum tillage to reduce soil erosion. Factors such as disease severity in past years and the slope of the land should be considered. Crop rotation and an increased number of years between soybean crops should be considered on sloping land where minimum tillage should be used.

Very few of the fungi and bacteria that attack soybeans infect other crop plants. Rotations with corn, small grains, or forages deprive soybean pathogens of a host on which to infect, reproduce, and carry-over between soybean crops.

Adequate, balanced soil fertility can be important in reducing disease losses. Less than adequate phosphorous or potash can contribute to losses from Septoria brown spot, several root rots, and pod and stem blight. Healthy, vigorous plants are more tolerant of diseases and better able to produce a near normal yield despite diseases.

Soybean yields for many varieties are greater at narrow row widths (10 inches) compared to wide row widths (30 inches or greater). However, higher yields with narrow rows may not be achieved because leaf and stem diseases can be more severe under a narrow row system. Growers using narrow rows should be more watchful for severe disease development.



---

# Fungicides

Fungicides may be used for control of soybean diseases in two ways.

## 1. Fungicidal seed treatment for soybeans may be beneficial under the following conditions.

- A. If it is desirable to use a minimum planting rate because of high seed cost and/or short seed supplies.
- B. If there is an excessive number of cracked seed coats, as may occur under dry harvesting conditions.
- C. If germination is below 80% or there are other indications of low seed vigor. Old seed or seed which has been invaded by disease-producing organisms such as *Phomopsis* (the pod and stem blight fungus) is more likely to respond to seed treatment.
- D. If the field is known to be heavily infested with soybean root-invading organisms such as *Pythium*, *Rhizoctonia* or *Phytophthora*.
- E. Early planting in cold, wet soils.

## 2. Foliar fungicides can be used to lower losses due to leaf diseases and pod and stem blight.

Pod and stem blight may reduce yield, but its major effect is through seed infection that results in reduced seed germination rates and reduced seedling vigor. Evaluations in Wisconsin reveal that foliar-applied fungicides reduce seed infection and improve germination. Foliar-applied fungicides for the control of leaf diseases and pod and stem blight have improved yields in Wisconsin tests, but this result has been inconsistent.

Soybean seed producers should consider the use of foliar fungicides to improve seed quality. The following factors should be considered before foliar fungicides are used.

- A. Potential risk. The diseases controlled by fungicide sprays are important when warm wet weather prevails during the pod fill stage. If, at bloom, the 30-day outlook is for warm wet weather, these diseases will be prevalent and fungicide sprays will be beneficial. Since two sprays are suggested on the product label, one at early pod development (upper pods 1/2 to 3/4 inches long), and a second spray 14-21 days later, an assessment should be made before the second application. If the weather has been dry since the first application and the forecast is for continued dry weather, the second application should not be made; if wet, the second application should be made. One application when upper pods are 3/4-1 inch long has been effective in Wisconsin trials.
- B. Was the field planted to soybeans the previous year? If soybeans have been grown for 2 or more consecutive years, disease severity potential will be higher than if rotation has been used.
- C. No-till or minimum tillage will increase the potential of disease.
- D. Early-maturing varieties usually suffer greater losses from disease controlled by foliar fungicides than full-season varieties.
- E. Benefits of improved seed quality from disease control may be an important consideration for applying fungicides to seed production fields.
- F. High yields (40 bu/A or more) should be anticipated if fungicide application is to be economical.
- G. A dense canopy of weeds will impede the movement of the fungicide to the soybean pods and foliage.

## Soybean Seedling, Root and Stem Health

Soybean health is compromised by several plant pathogenic fungi that infect plants at different growth stages. Although infections may occur early, many of these pathogens do not cause apparent symptoms until later growth stages. Frequently seedling health is ignored because plant populations are acceptable and stem and leaves do not express symptoms during early vegetative growth. *Phytophthora*

sojae, *Pythium* spp. and *Rhizoctonia solani* are believed most important, but other plant pathogens are actively invading plants from growth stages VE to V4. Plant health assessment is important during this phase. This information may be used to make adjustments in crop management in subsequent years, and this information may explain symptoms later in the season and less than anticipated yield at harvest. Symptoms caused by pathogens are confounded by symptoms caused by herbicides and other abiotic causes of plant stress. Many pathogens infect plants at VE-V4, cause chronic symptoms or remain latent, but cause symptoms of plant decline during the reproductive growth stages (see summary table).

## SUMMARY SOYBEAN SEEDLING, ROOT AND STEM HEALTH

Disease	Cause	Growth Stage	Symptoms	Control	Comments
Seed rot	<i>Pythium</i> , <i>Phytophthora</i> , <i>Phomopsis</i>	V0-VE	Soft decay of seed; missing seedlings in row.	Fungicide treated seed, <i>Phytophthora</i> resistant variety.	Favored by cool and wet soils. <i>Phomopsis</i> comes with seed.
Seedling Mortality	<i>Phytophthora</i> , <i>Rhizoctonia</i>	VE-V4	Chlorotic and wilting leaves followed by necrosis; leaves remain attached to stem.	Fungicide treated seed, <i>Phytophthora</i> resistant variety.	<i>Phytophthora</i> is most common cause of early seedling mortality in Wisconsin.
Root and lower stem decay	<i>Rhizoctonia</i> , <i>Fusarium</i> , <i>Phytophthora</i> , <i>Mycoleptodiscus</i>	VE-V6	Reddish-brown lesions on taproot and hypocotyl; usually superficial; <i>Phytophthora</i> causes brown lesions on stem above soil-line.	Fungicide treated seed, <i>Phytophthora</i> resistant variety; ridging soil around stems by cultivation simulates new roots.	Except for <i>Phytophthora</i> , above ground plant parts may not express symptoms.
Premature decline of foliage and stems	<i>Rhizoctonia</i> , <i>Mycoleptodiscus</i> , <i>Fusarium</i> (sudden death syndrome), <i>Phialophora</i> (brown stem rot)	R1-R7	Wilt, chlorosis and eventually necrosis of leaves; inter-veinal tissues progress from yellow to brown, but major veins remain green (SDS & BSR); internal browning of stems (BSR).	Fungicide treated seed; variety selection	Brown stem rot ( <i>Phialophora</i> ) & sudden death syndrome ( <i>Fusarium</i> ) cause unique symptom patterns on leaves; general decline may be due to <i>Rhizoctonia</i> or <i>Mycoleptodiscus</i>



---

## Pythium Seed Rot



Several species of *Pythium* are pathogens of soybean. *Pythium spp.* are soil inhabiting fungi that cause seed rot, and pre-emergence and post-emergence seedling death. *Pythium* is most active when soil moisture is high. Most *Pythium* species are most active in cool soils, but exceptions are reported. Diseased seedling tissues are initially water-soaked and gradually become brown with time. Diseased seedlings disintegrate and gaps in the rows are the only evidence of a problem.

### Controls

Avoid planting in soil conditions that favor disease. 2) treat seed with fungicides and 3) plant seed with good germination and seeding vigor.

---

## Rhizoctonia Seed Rot and Seedling Blight

*Rhizoctonia solani* primarily infects seed and seedlings but can continue to cause root rot of older plants (for image see *Pythium* Seed Rot). *Rhizoctonia* seedling disease occurs during prolonged periods of warm and wet soil and when conditions are unfavorable for vigorous plant growth. Typically, a reddish-brown decay of the outer tissues appear on the stem base, crown and roots. This may develop into sunken reddish brown cankers which sometimes girdle the stem at the soil line. In relatively dry, windy weather, plants may die if the stems and roots are extensively diseased.

### Control

Plant sound, high-quality seed, 2) avoid planting when soil conditions favor infection and 3) treat seed with a fungicide.

---

## Phytophthora Seed Rot and Seedling Blight

*Phytophthora megasperma* is more noted as a root and stem pathogen of soybean. However, this fungus can cause seed rot and pre-emergence seedling death (for image see *Pythium* Seed Rot). Symptoms are similar to those caused by *Pythium*. However, *Phytophthora* is more aggressive when soils are warm and wet compared to most *Pythium* species which prefer wet, but cool soil conditions.

### Control

1) Resistant varieties, 2) early planting, and 3) fungicide seed treatment are potential control measures.

---

## Phomopsis Seed Rot

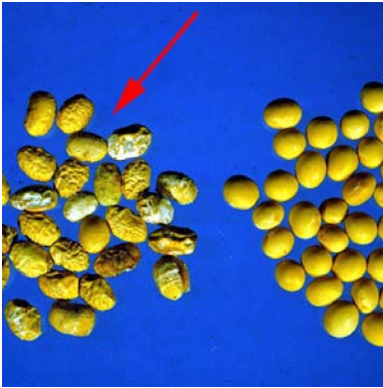

*Phomopsis sojae* is a seed-borne fungal pathogen of soybean. Infection occurs through pod walls and progresses into the seed. Many seeds are destroyed in the pod and are never planted. However, many infected seeds show no obvious symptoms and are used for seed. Phomopsis can reduce germination and seedling vigor and reduce stands with seedlings of poor vigor result.

Germination tests may identify Phomopsis infection as the cause of low seed germination. Such seeds should not be planted. However, in some cases, growers are forced to plant seeds with marginal germination.

### Control

Treatment of seeds with the systemic fungicide carboxin can improve germination of seeds if Phomopsis is the cause of germination problems.

---

## Phytophthora Stem and Root Rot



Phytophthora root rot (PRR), caused by the fungus *Phytophthora sojae* is a very destructive soybean disease in Wisconsin. Two major factors are contributing to an increase in the occurrence of this disease: 1) the soybean acreage is increasing and, consequently, soybeans are planted more frequently in specific fields, and 2) many races of Phytophthora exist in Wisconsin soils and there are no soybean varieties resistant to all races. Phytophthora can kill plants at all stages of growth and reduce stands, or infected plants may survive, but are less productive. The incidence and severity of disease depend on soybean variety, soil type, soil drainage, rainfall, and cultural practices. Phytophthora root rot appears most frequently in fields with poor internal drainage, but the disease can occur in normally well-drained fields that are saturated for 7-14 days due to excessive precipitation or irrigation.

## Symptoms

*Phytophthora sojae* can infect soybean seeds causing seed rot, or it can kill seedlings before or after emergence. Symptoms of post-emergence infection are wilting and death of soybean seedlings as they emerge. Stems of older seedlings in the primary leaf stage may become watersoaked and eventually leaves will turn yellow, wilt and die. As plants age, they die more slowly after infection. Plants infected before flowering exhibit a yellowing of leaves, followed by wilt and death. The leaves remain attached after death. A key diagnostic symptom is a brown discoloration that progresses 6-12 inches up the stem from the soil line. Diseased root systems are reduced and the taproot and lower stem are discolored internally.

The root rot phase of PRR is not as readily recognized as the killing stem rot phase. Although less drastic in appearance, the root rot phase can greatly reduce plant productivity. Infected plants in the root rot phase will be a lighter green, and may be stunted and exhibit uneven growth. These symptoms are the result of a diseased root system that is less efficient in supplying the plant with water and nutrients. The nodules formed by beneficial nitrogen-fixing bacterial (*Rhizobium*) are often destroyed and the plants become yellow, partially due to nitrogen deficiency. The soybean variety, the race(s) of *Phytophthora sojae* present, and environmental conditions will determine whether the killing phase or root rot phase will be most prevalent.

*Phytophthora* root rot is sometimes misdiagnosed as injury caused by herbicides, especially when the crop is in the seedling stage. Both PRR and herbicide injury can produce stunted plants with yellow or dead leaves. However, the brown discoloration of the stem originating at the soil line is a key symptom of PRR. Herbicide injury very rarely produces this type of stem symptom. Many herbicides will cause affected leaves to be detached from the plant. Also, PRR occurs throughout the growing season, whereas injury from herbicide occurs early in the season.

## Races of the *Phytophthora*

In 1963, fully-resistant varieties became available to control race 1 of *Phytophthora sojae*, the only race (strain) identified in the Midwest at that time. In 1972 in Ohio, a new race of the pathogen was found that infected varieties previously considered resistant. Since 1972, additional races have been identified in many Midwestern states. Twenty races of *Phytophthora* now have been identified in Wisconsin. There are no soybean varieties in the state that are highly resistant to all races, but many exhibit a moderate degree of resistance which is often described as tolerance. Fortunately, all the races seldom occur in the same field. If only race 1 susceptible varieties are planted in a field, generally race 1 will be predominant. However, if race 1 resistant soybean varieties are grown, other PRR races may become prevalent. Race 3 has been the most prevalent of the new races, but race 4 and similar races are appearing with increasing frequency.

## Control Strategies

### *Phytophthora* Race Identification

Growers should know which races of *Phytophthora sojae* are present in their soybean fields because the races present will influence the performance of soybean varieties. To determine the races of *Phytophthora* in a field, collect recently killed plants from several areas of the field and submit them to your University of Wisconsin-Extension office. Even if the incidence of disease is minimal, growers should have the race identified to determine the potential problem. Soil sampling is another way to determine the *Phytophthora* race. Soil samples should be collected from several sites in the field where *Phytophthora* root rot is observed. Combine the samples into a one quart volume per 20 acres of land. Contact your University of Wisconsin-Extension office if you plan to submit plant or soil samples to the Department of Plant Pathology, University of Wisconsin-Madison

## Summary on tactics available for integrated control of Phytophthora root and stem rot (PRSR) of soybean

### Host Resistance

- 1) **Race-specific, 16 genes identified.** Each confers resistance to specific races.
- 2) **Many races of the pathogen exist.**
- 3) **Nonrace-specific; also termed field tolerance, tolerance, or rate-reducing resistance.** This form of resistance is more sensitive to environmental factors, less effective in seedling stage.
- 4) **Relative maturity influences the performance of tolerant cultivars for a specific region.** A cultivar will express more tolerance in the northern extent of its adaptation.

### Soil Structure

#### 1) **Tillage influences bulk density:**

Spring tillage reduces bulk density and decreases disease.

Excessive tillage or tillage under wet soil conditions increases bulk density and disease.

Reduced tillage or no-till increases PRSR.

#### 2) **Avoid practices that compact soils.**

#### 3) **Surface and subsurface drainage.**

### Plant Nutrition

#### 1) **Soil applied nitrogen enhances PRSR.**

#### 2) **Chloride salts increase PRSR; sources are:**

Muriate of potash.

Manure.

Sewage sludge.

### Planting Date

#### 1) **Plant early to avoid warmer soils.**

#### 2) **Pythium problems can be more severe in early plantings,** thus, fungicide seed treatment can be beneficial.

### Crop Rotation

#### 1) **Minor effect on reducing PRSR.**

#### 2) **Role of other hosts is not known.**

### Chemical

#### 1) **Formulations of metalaxyl (fungicide):**

Apron, seed dressing.

Ridomil, soil applied fungicide.

#### 2) **Metalaxyl cannot replace host resistance, but should be used to supplement.**

## Symptoms

Symptoms are not expressed until after pod development has begun. Internal stem symptoms are first evident at the lower regions of the stem and appear as browning of the vascular system and pith tissues. In time internal stem browning can progress to the top of the stem. Foliar symptoms appear in August to early September depending on the relative maturity of the variety. In fact brown stem rot is often confused with early maturity. Foliar symptoms start as a gradual yellowing followed by wilting, curling and death of leaves. Tissues between leaf veins progress in this manner, but the veins remain green for an extended period of time.

## Epidemiology

The brown stem rot fungus survives in soybean debris and will do so until the debris decays. Thus, crop rotation can be used to prevent damaging levels of the fungus from building up in the soil. Infection occurs through roots and the pathogen travels in the vascular system of the plant. Optimal soil moisture and moderate air temperatures favor the development of brown stem rot. The disease is most damaging under high yield potentials. Yield can be reduced up to 35% by this disease. It is difficult to achieve yields of 45 bu/a or more when this disease is present.

## Control

Crop rotation can be used to control brown stem rot, but at least 2 years of a non-host crop are needed between soybean crops. Corn and small grains are excellent non-hosts crop. However, red clover is the only crop commonly grown in Wisconsin that is unsafe to use in rotation with soybeans with regard to brown stem rot.

BSR 201 and BSR 101 are recently released varieties that have resistance to brown stem rot. Both varieties will produce 10-25 bu/a more than susceptible ones when grown on infested land. More resistant varieties should be available in the future and promise better control of this disease in the future. This especially true when shorter rotations are desired.

---

# Brown Stem Rot



Cause: The fungus *Phialophora gregata*.

## Symptoms

Symptoms are not expressed until after pod development has begun. Internal stem symptoms are first evident at the lower regions of the stem and appear as browning of the vascular system and pith tissues. In time internal stem browning can progress to the top of the stem. Foliar symptoms appear in August to early September depending on the relative maturity of the variety. In fact brown stem rot is often confused with early maturity. Foliar symptoms start as a gradual yellowing followed by wilting,



curling and death of leaves. Tissues between leaf veins progress in this manner, but the veins remain green for an extended period of time.

## Epidemiology

The brown stem rot fungus survives in soybean debris and will do so until the debris decays. Thus, crop rotation can be used to prevent damaging levels of the fungus from building up in the soil. Infection occurs through roots and the pathogen travels in the vascular system of the plant. Optimal soil moisture and moderate air temperatures favor the development of brown stem rot. The disease is most damaging under high yield potentials. Yield can be reduced up to 35% by this disease. It is difficult to achieve yields of 45 bu/a or more when this disease is present.

## Control

Crop rotation can be used to control brown stem rot, but at least 2 years of a non-host crop are needed between soybean crops. Corn and small grains are excellent non-hosts crop. However, red clover is the only crop commonly grown in Wisconsin that is unsafe to use in rotation with soybeans with regard to brown stem rot.

BSR 201 and BSR 101 are recently released varieties that have resistance to brown stem rot. Both varieties will produce 10-25 bu/a more than susceptible ones when grown on infested land. More resistant varieties should be available in the future and promise better control of this disease in the future. This especially true when shorter rotations are desired.

---

# Sclerotinia Stem Rot



Cause: The fungus *Sclerotinia sclerotiorum*.

## Symptoms

Symptoms do not appear until 2 weeks or more after flowering. Leaves become chlorotic, but in most cases wilt and take on a gray-green color. Stems provide the best diagnostic symptoms. Stem lesions begin at nodes and progress in both directions and become bleached in appearance. Fluffy white mycelium (mold) is abundant during moist conditions and black survival structures called sclerotia may form amongst the white mold.

## Epidemiology

Sclerotinia has a wide host range consisting of all broadleaf plants. The disease on soybeans is usually more severe when soybeans are planted immediately after another host crop. The pathogen survives many years in the soil. Wet and cool weather conditions favor the disease.

## Control

Avoid the following cultural practices if the disease is a threat; 1) plant soybeans using 30 inch wide row spacings or more, 2) avoid planting varieties that excessively lodge, 3) stop irrigation at flowering, and 4) do not grow other susceptible hosts (e.g., snap beans or sunflowers) in rotation with soybeans. Some soybean varieties are less susceptible to Sclerotinia stem rot, the degree that they can be diseased is influenced by weather and the cultural practices listed above.

---

# Soybean Cyst Nematode

Craig R. Grau, Ann E. MacGuidwin, Edward S. Oplinger

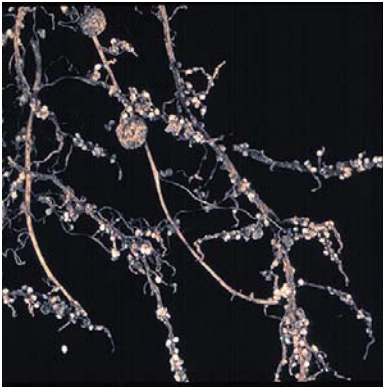

Soybean cyst nematode, *Heterodera glycines*, is a small, unsegmented plant-parasitic roundworm that attacks the roots of soybeans. This soilborne pathogen was detected in southeastern Wisconsin in 1980. As of the fall of 2002, soybean cyst nematode has been detected in 26 counties in Wisconsin. Currently, severe soybean cyst nematode problems are associated more with sandy soils. However, yield loss due to soybean cyst nematode does occur on silt-clay loam soils. The soybean cyst nematode problem tends to be more chronic on heavier soils, but may cause a significant “yield drag” on the soybean crop.

## Field Diagnosis

Field diagnosis of soybean cyst nematode is possible by visual effects (symptoms) of the soybean cyst nematode on plants and the visual detection of the soybean cyst nematode on roots (signs). Symptoms caused by the soybean cyst nematode can be observed shortly after seedlings emerge, but more typically symptoms are expressed in the mid to late vegetative stage. Signs of the soybean cyst nematode begin to appear on roots 6 weeks after emergence. Symptoms may be absent for several years following introduction of the nematode into a field, but are expressed as population density increases with soybean cultivation. The above-ground symptoms, when present, may appear in circular or oblong patterns which vary in size or may be more generalized across much or all of the field. Above-ground symptoms may initially appear near an entrance to a field where farm machinery enters or along a fence line where wind-blown soil tends to accumulate.

## Above-ground Symptoms

When above-ground symptoms appear, they are not unique and can be mistaken for damage caused by soil compaction, nutrient deficiencies, drought stress, herbicide injury, or other plant pathogens. Often, soybean injury and yield loss due to soybean cyst nematode have probably gone undetected for several years because of absence of above-ground symptoms or misdiagnosis of these nonde-

script symptoms. Yield loss can occur in the absence of obvious symptoms before the soybean cyst nematode is detected. This chronic phase may result in significant yield loss for several years because growers or crop advisors are not aware of the soybean cyst nematode. Chronic soybean cyst nematode problems may be recognized by less than anticipated yields with no feasible explanation as to why yields are low.

The first obvious symptom of soybean cyst nematode injury to soybeans is the appearance of stunted, yellowed, less vigorous plants. Plants growing in heavily infested soils may remain stunted throughout the growing season. Additionally, rows of soybeans grown in infested fields are often slow to close with foliage. Slow canopy closure frequently results in weeds breaking through the crop canopy later in the growing season. Yellowing due to soybean cyst nematode damage will occur early in highly infested fields, but can occur later in the season, usually in July and August, in moderately infested fields. Symptoms can range from severe to nonexistent. The intensity of the symptoms is influenced by the age and vigor of the soybean plants, the nematode population density in the soil, soil fertility and soil moisture levels, and other environmental conditions. Soybean cyst nematode damage is usually more severe in light, sandy soils, but will occur in all types of soil.

## **Below-ground Symptoms and Signs**

Most below-ground symptoms of soybean cyst nematode injury are not unique. Roots infected with the nematode are dwarfed or stunted. Soybean cyst nematode also decreases the number of nitrogen-fixing nodules on the roots, which leads to light green to yellow foliage. Furthermore, infection of roots by soybean cyst nematode may make the roots more susceptible to infection by other soil-borne plant pathogens. It is often difficult to recognize roots as being stunted and having fewer nodules unless some infected soybean roots are also available for side-by-side comparison.

The only unique sign of soybean cyst nematode infection is the presence of adult female nematodes and cysts on the soybean roots. Female and cysts appear as tiny, lemon-shaped objects which are initially white but turn yellow, then tan to brown as they mature. Females and cysts can be seen on infected roots with the unaided eye, although observation with a magnifying glass is usually much easier. The females and cysts are about the size of a period at the end of a sentence and are much smaller than nitrogen-fixing nodules. Roots should be carefully dug, not pulled, from the soil to observe the nematodes on the roots, otherwise many of the females and cysts may become dislodged. Observation of the nematodes on the roots of infected soybean plants is the **ONLY** accurate way to diagnose soybean cyst nematode infestations in the field. In most years, such diagnoses can be performed beginning four to six weeks after planting and continuing through September in Wisconsin.

## **Analysis of Soil**

Above-ground symptoms for identification of soybean cyst nematode infestations cannot usually be relied upon. If soybean yields in a particular field have decreased for no apparent reason or if soybean cyst nematode has been confirmed on nearby land, more thorough examination of plants for below-ground symptoms and a soil analysis are needed. Plant symptoms are important, but a laboratory analysis of soil compliments or verifies the accuracy of field diagnoses. A laboratory analysis defines the population density of soybean cyst nematode and can be taken on as an extra step to determine the race or races of soybean cyst nematode in a specific field. The soil from soybean fields should be sampled to determine:

1. The presence of soybean cyst nematode
2. The population density of soybean cyst nematode
3. The race of soybean cyst nematode in specific fields

Soil should be collected in a systematic pattern within a 15 to 20 acre area. Fields can be sampled anytime of the year, but spring samples may be more predictive of the level of risk due to soybean cyst nematode. A small trowel may be used to collect soil, but a 1-inch soil probe is preferred to collect soil at 15 to 20 sites within a 15 to 20 acre block of land. The soil should be collected at a depth of 6 to 8 inches within the rows if possible, and placed in a container. The soil should then be mixed thoroughly

and placed in bags that retain moisture to prevent the drying of the soil. The soil samples do not need to be refrigerated, but should be kept cool by not placing the samples in direct sunlight or near other sources of heat. The samples should be submitted quickly to a laboratory that analyzes soil for soybean cyst nematode. Send samples to the:

Plant Disease Diagnostics Clinic  
1630 Linden Drive  
University of Wisconsin - Madison  
Madison, WI 53706-1598

The following information is important when submitting samples:

1. Cropping history of the area sampled
2. Soybean variety most recently planted
3. Acreage that the sample represents
4. Soil pH, organic matter, and nutrient levels

## **Life Cycle**

The soybean cyst nematode life cycle has three major stages: egg, juvenile, and adult. The life cycle can be completed in 24 to 30 days under optimum conditions in the summer, and three to four generations per growing season are possible in the Midwest. Worm-shaped soybean cyst nematode juveniles hatch from eggs in the soil when adequate temperature and moisture levels occur in the spring. These juveniles are the only life stage of the nematode capable of penetrating and infecting soybean roots. Juveniles move through the root until they establish a specialized feeding site in the vascular tissue. As the nematodes feed, they change from worm-like to a lemon shape. Eventually female nematodes break through the root tissue and are exposed on the surface of the root.

After fertilization, the males die and the females remain attached to the roots and continue to feed. The swollen females begin to produce eggs, initially in a mass or egg sac outside the body and later within the body cavity of the female. The entire body cavity of the adult female eventually becomes filled with eggs, and the female dies. It is the egg-filled body of the dead female that is referred to as the cyst. Cysts will eventually dislodge from the roots and become free in the soil. The walls of the cyst become very tough and provide excellent protection for the 200 to 400 eggs contained within. Soybean cyst nematode eggs survive within the cyst until conditions become proper for hatching. Although many of the eggs may hatch within the first year, many will also survive within the cysts for many years.

## **Management**

For all practical purposes, soybean cyst nematode can never be eliminated from soil once it is present. However, strategies are available that curb reproduction and pathogenic effects of the soybean cyst nematode.

### **1. Sanitation**

Knowledge of how the soybean cyst nematode is spread is important to growers concerned about this destructive pest. The soybean cyst nematode can move through the soil only a few inches per year on its own power. However, it can be spread great distances by anything that moves even small amounts of soil. Spread can occur by soil moved by farm machinery, vehicles and tools, wind, water, seed-sized clumps of soil, animals, and farm workers. There is even evidence that cysts of soybean cyst nematode can be spread by birds, especially migratory water fowl. Known infested fields should be tilled last if possible. Finally, equipment should be thoroughly cleaned with high pressure water, or steam, if available, after working in infested fields. In reality, despite these precautions, it is most likely that all fields are infested with soybean cyst nematode once obvious symptoms are observed on a farm.

## 2. Maintenance of Plant Health

Plants that have adequate moisture and soil fertility are better able to withstand infection by soybean cyst nematode. However, maintaining proper soil fertility and pH levels in land infested with soybean cyst nematode should not be considered a primary control strategy, but rather a means to supplement crop rotation and resistant varieties. Plant stress caused by other pathogens renders plants more susceptible to the yield suppressing effect of the nematode.

## 3. Crop Rotation

Planting nonhost crops can be very effective in preventing or delaying the spread of soybean cyst nematode to noninfested land. Soybean cyst nematode is an obligate parasite and is unable to develop and reproduce in the absence of host roots. Nematode densities decline during any year that nonhost crops are grown. Alfalfa, corn, and oats are common nonhost crops grown in Wisconsin, and soybean cyst nematode densities decline similarly when infested soils are planted with these three crops. Snap beans, dry edible beans, and lima beans will support reproduction of soybean cyst nematode and present a risk to soybeans, and are commonly planted in Wisconsin. Newly acquired land should be sampled for the soybean cyst nematode.

## 4. Host Resistance

Resistant soybean varieties are an effective strategy to enhance a soybean yield while managing the presence of soybean cyst nematode. A direct benefit is higher yields from resistant compared to nonresistant varieties, but an indirect benefit is that a resistant variety can suppress soybean cyst nematode reproduction. By planting resistant soybeans in infested soil, reproduction of the nematode is suppressed and population densities may decline in time. In the past, there were few resistant varieties available for Wisconsin, but in recent years many public and private varieties have been released. Virtually all soybean cyst nematode resistant soybean varieties available in Wisconsin were bred for resistance using one of two soybean breeding lines, 'Peking' or 'PI88788'.

Although, use of resistant varieties is the most effective management strategy for soybean cyst nematode, **RESISTANT VARIETIES SHOULD NEVER BE PLANTED YEAR AFTER YEAR.** If resistant varieties are planted several years in a row, eventually a population (or race) of soybean cyst nematode may develop which is capable of reproducing on the resistant varieties. Growers are encouraged to alternate use of soybean varieties with the two different sources of soybean cyst nematode resistance. Furthermore, it is recommended that a susceptible soybean variety be grown once after both types of resistance have been used to offset the effect of growing the resistant soybean varieties. The following is a recommended six-year rotation scheme using both types of soybean resistance in conjunction with susceptible soybean varieties and nonhost crops for integrated management of soybean cyst nematode. It should be noted that soybeans should never be grown in monocultures. Even an alternating corn-soybean rotation can be vulnerable to plant pathogens. Growers should consult county Extension personnel and seed company representatives for information on suitable resistant soybean varieties and their source of soybean cyst nematode resistance or to further discuss other aspects of effective crop rotation schemes.

- 1st year - Nonhost crop
- 2nd year - 'PI88788' Resistant soybean
- 3rd year - Nonhost crop
- 4th year - 'Peking' Resistant soybean
- 5th year - Nonhost crop
- 6th year - Tolerant (high-yielding), Susceptible soybean

## 5. Nematicides

There are several nematicides which are labeled for use against soybean cyst nematode, but often do not give season long control. The performance of the nematicide will depend on soil condi-



tions, temperatures, and rainfall. A yield benefit is not guaranteed, and nematicides are expensive. Consequently, growers are advised to consider economic, environmental, and personal health factors before utilizing nematicides for management of soybean cyst nematode.

---

## Soybean Virus Diseases

Within the past five to ten years, soybean growers and researchers in Wisconsin have become increasingly aware of the importance of viral pathogens in soybean production. Several viral pathogens including alfalfa mosaic virus (AMV), bean pod mottle virus (BPMV), soybean mosaic virus (SMV), tobacco streak virus (TSV) and tobacco ringspot virus (TRSV) have been recovered from soybeans in the state. Of these viruses, BPMV, SMV and AMV in particular appear to have the greatest potential for serious impact on soybean production, with BPMV reported to have caused 10 to 40% yield reductions in some areas.

### Symptoms

Symptoms of infection by viral pathogens can vary greatly depending upon the virus or viruses involved, the specific soybean cultivar that is infected and environmental conditions. Interactions between several viruses, when they occur in the same plant, can influence symptom development as well.

Abnormal leaf color and development are typical symptoms associated with viruses. A classic leaf symptom associated with AMV, BPMV, SMV and TSV infections is mosaic or mottling, a randomly blotchy discoloration of leaf tissue. A crinkling of leaf tissue, and elongation and narrowing of leaves is oftentimes associated with mosaic symptoms. Vein clearing (a yellowing of veins) is another, often transitory symptom of viral infections. Green stem, the abnormal retention of green leaves and petioles at plant maturity, is a leaf symptom often associated with BPMV and SMV.

Viral infections can also lead to abnormalities in flowering, pod formation and seed production. Plants infected with TSV and TRSV may produce excessive numbers of flower buds from a given point on a soybean stem (a phenomenon called bud proliferation), and pods produced on infected plants can be malformed and distorted. Infections by TRSV, as well as BPMV and SMV, can cause pod discolorations. Seeds produced by plants infected with BPMV, SMV and TSV are also often discolored. Common seed symptoms include mottling of the seed coat (typically around the hilum) that looks like bleeding ink, or even discolorations of the internal seed tissue. Discolored, virus-infected seed often has a poor germination rate.

Because different viruses can often cause very similar symptoms, a laboratory analysis is typically required to determine which specific virus or viruses may be causing problems. Contact your county Extension agent for details on the soybean virus testing that is available in your area.

Finally, symptoms due to viral infections, particularly foliar symptoms, are very similar to symptoms caused by herbicide injury. In order to distinguish between symptoms caused by viruses, and those caused by herbicides, look at the pattern of symptom development. Virus-infected plants typically occur in irregularly-sized patches, and symptoms, once they develop will persist for the entire growing season. Symptoms due to herbicide injury are typically more uniform. They typically follow the row direction and may be more prevalent where overlap of spray could have occurred. Plants exposed to herbicides typically grow out of their abnormal growth and eventually produce foliage that looks normal.

### Epidemiology

Soybean viruses can be introduced into soybean fields in a variety of ways. SMV is brought into fields in infected seed. Seed infection rates of 1-5% have been reported for this virus. TSV has also been reported to be transmitted at high frequency in seed. BPMV can be seed-transmitted, although the frequency with which this virus is carried in seed (< 1%) is less than that for SMV or TSV, and this means

of transmission is considered relatively unimportant epidemiologically. For BPMV, the primary means of introduction of the virus into a soybean field is via bean leaf beetles. If winter temperatures are mild, substantial numbers of adults that are carriers of BPMV can overwinter and these adults can transmit the virus to soybeans during feeding. Later generation bean leaf beetles can acquire the virus from legume hosts (either infected soybeans or infected legume weeds) and thereafter move the virus as they continue to feed. The primary source of inoculum for AMV is infected forage legumes such as alfalfa. This virus is moved from forages to soybeans by aphids. Forage legumes can also serve as a reservoir for TSV (although forages are a less important source of this virus than contaminated seed) and this virus is subsequently moved into soybean fields by thrips.

Once introduced into a field, soybean viruses can spread rapidly. SMV and AMV are moved from plant to plant by aphids, which pick up these viruses as they feed on infected plants, then drop off the viruses as they feed on noninfected plants. Similarly, BPMV is moved from plant to plant as bean leaf beetles feed. As noted above, TSV can be moved from plant to plant by thrips.

## **Management**

Because management strategies vary from virus to virus, the first step in managing soybean virus diseases is to determine the viruses your soybeans are likely to encounter. Plan a virus management strategy that is tailored to potential viruses in your area. Oftentimes information on virus problems from previous years provides the best insight on potential problems in the current growing season.

Be sure to select high quality seed. Inspect seed prior to purchase for discolorations that are typical of viral infections and do not purchase seed that appears infected. Use of high quality seed is particularly important in preventing introduction of SMV and TSV into fields.

Select varieties that are potentially resistant to viral pathogens. Current soybean varieties have not been bred specifically for virus resistance. However, if you have grown varieties in the past under conditions favorable for viral problems to develop and you have not observed viral symptoms, these varieties may have some resistance and should be considered for future use.

Modify seed planting dates and rates. Delay planting soybeans when BPMV is of concern to avoid overwintering adult bean leaf beetles that may be carrying this virus. If AMV or SMV are of concern, plant as early as possible. Early planting allows plants to grow substantially before they are likely to encounter aphids carrying these viruses. Infections that occur in later growth stages of a soybean plant tend to lead to less severe symptoms and yield losses than infections that occur early in growth. Also, soybean stands that are uniform, relatively dense and relatively non-stressed tend to be less attractive to insects (particularly aphids) that carry viruses.

Use of insecticide may help reduce the incidence and severity of BPMV. Threshold values for the bean leaf beetle have not been determined in the context of BPMV transmission. However, if BPMV has historically been a problem, insecticide sprays applied in the early stages of plant development (VC-V2) may help kill overwintering adult bean leaf beetles than might lead to early infections by the virus. A second insecticide application may also be necessary in late June or early July as first generation bean leaf beetles emerge. At this time, synthetic pyrethroid insecticides appear to provide the most consistent control for bean leaf beetles. Note that currently, insecticide treatments have not been demonstrated to be effective for control for vectors of other common soybean viruses (e.g., aphids).

## Contents

Chapter 5: Wheat . . . . .	1
Quick Reference Photos. . . . .	2
Insect Profiles . . . . .	3
Aphids . . . . .	3
Armyworm . . . . .	5
Cereal Leaf Beetle. . . . .	6
Wireworms. . . . .	7
Wheat and Barley Disease Management . . . . .	9
Disease Profiles . . . . .	9
Leaf rust and stem rust . . . . .	9
Loose Smut of Wheat . . . . .	10
Barley Yellow Dwarf of Wheat . . . . .	11
Head Blight or Scab of Wheat. . . . .	12
Septoria Leaf Blotch . . . . .	13
Powdery Mildew . . . . .	14

# Quick Reference Photos

## Wheat Insects

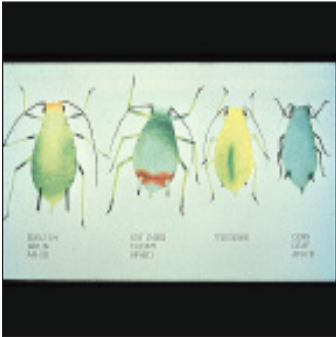

Aphids



Armyworm



Cereal Leaf Beetle



Wireworm

## Wheat Diseases



Leaf rust and stem rust



Loose Smut of Wheat



Barley Yellow Dwarf of Wheat



Head Blight or Scab of Wheat

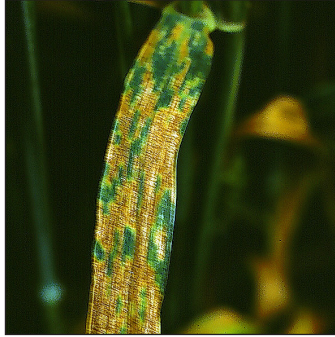

Septoria Leaf Blotch



Powdery Mildew

# Insect Profiles

---

## Aphids

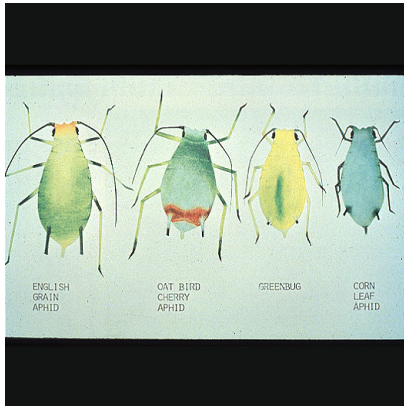

### Description

The English grain aphid, bird-cherry oat aphid, corn leaf aphid and greenbug are our most common species; adult aphids are approximately 1/16 - inch long. Winged and wingless forms may be found on the same plant, and it is possible to find all species in the same field. The English grain aphid usually is dark green, but can be yellow or pink with a brown head. There is often a dusky dorsal patch on the abdomen. The long cornicles (two small tubes extending back from the rear of the abdomen) and antennae are entirely black.

The bird-cherry oat aphid, is mottled yellowish or olive green to greenish black. Often there are reddish patches around the bases of the cornicles. The antennae are entirely black, but the legs and cornicles are green with black tips.

The corn leaf aphid is a small, bluish-green to gray, soft bodied insect about the size of a pinhead. They may be winged or wingless. Both the immature nymphs and adults appear similar and it is often difficult to distinguish between the two.

The greenbug, the least common of the three species, are pale green with a darker green stripe down the middle of the back. The legs and cornicles are also green, except for the tips which are usually black.

### Life cycle

For aphids to survive winter in northern latitudes they must be capable of producing eggs in the fall. Both the bird-cherry oat aphid and the English grain aphid do this and they are believed to overwinter in Wisconsin. During the rest of the year they exist as parthenogenetic females. That is, they give birth to living young without fertilization. The corn leaf aphid and greenbug, does not produce eggs under our conditions and are not believed to overwinter here. Our infestations originate from winged migrants from southern states.

Aphids are very prolific and a single female usually gives birth to 10-30 offspring, which doesn't sound dramatic until one realizes that generations may overlap. The first-born of an individual may mature and begin reproduction while its mother is still bearing young. Under optimal growing conditions, a 20-fold population increase in one week is not uncommon.



## Damage

Aphids damage small grains by sucking sap and transmitting Barley Yellow Dwarf Mosaic Virus (BYDV) while feeding. Although BYDV is not widespread in Wisconsin during most years it is capable of being a serious problem during years with an early arrival of spring that is accompanied by reinforcement of our overwintering populations with winged virus carrying migrants from southern states.

The greenbug injects a toxin chemical while feeding that causes enzymatic destruction of cell walls which leads to chlorosis (reddening and yellowing) and eventually necrosis (browning) of leaf tissue.

BYDV is a persistent aphid-transmitted virus. As the name implies, it attacks barley but can also infect wheat and oats. In oats the disease is called oat red leaf because of the characteristic symptoms. The plants eventually turn various shades of yellow-red, orange-red or reddish-brown. Plants are stunted if infection takes place early and spikelets are blasted. Root development is also reduced. Yields may be reduced 50 percent or more. Of our small grains, most of the damage is found in oats.

These aphids can also reduce yields even in the absence of the virus. Seedlings are the most susceptible to injury, which may result in plant loss, stunting and delayed maturity. Injury to older plants causes stunting and reduced kernel size and quality. As the plants mature, the English grain aphid exhibits the tendency to move to the head of the plant.

## Scouting suggestions

Examine the number of aphids per plant by sampling plants in 10 areas of each field. Separate the aphids as to species because the economic thresholds will vary.

## Economic thresholds

There are no thresholds for disease control because it is basically impossible to control BYDV by insecticidal means. However in terms of direct plant damage caused by aphid feeding the following treatment thresholds are suggested:

Growth stage	Bird-Cherry Oat Aphid, English Grain Aphid	Greenbug
Seedling	30 aphids per stem	20 aphids per stem
Boot to heading	50 aphids per stem	30 aphids per stem

## Control

Consult UW Extension Bulletin "Pest Management if Wisconsin Field Crops" A3646 for control recommendations. This bulletin maybe purchased from your local county extension office or is available to view, purchase or download from UW Cooperative Extension's The Learning Store at <http://learningstore.uwex.edu/>

---

# Armyworm



## Description

Fully grown larvae are approximately two inches long, are greenish to nearly black, and usually have a prominent pale stripe along each side and a thin pale stripe down the center of the back. As larvae grow larger they become more voracious and damage seems to appear almost overnight.

The adult is a rather nondescript buff moth with a wingspread of about 1-1/2 inches and a small white spot in the center of each forewing. The female lays eggs on the leaves of grasses in groups of up to 500. The female also folds the leaf and cements the edges of the leaf over the cluster of eggs with a sticky secretion. Eggs are most frequently laid in dense stands of grasses and in lodged areas of small grain fields.

## Life cycle

Moths appear as early as April either from a dispersal flight from southern states or possibly from overwintering pupae or adults. These early moths deposit eggs on grass blades and an early generation of larvae matures and pupates without apparent damage to small grain. Moths emerge from these pupae and begin to fly in late June and early July and it is the resulting larvae that cause our problems in small grain crops. In early July, armyworms feed on grassy weeds and small grain leaves; they frequently will clip the stem just below the grain head as the crop nears maturity. Armyworms will move from field to field when numerous; hence the name "armyworm". When mature, the worms enter the soil and change into a pupae. This produces moths that start a third generation which is of no consequence to small grain production.

## Damage

Although defoliation can result in reduced yields the real threat to production results from the clipped heads.

## Scouting suggestions

To guard against severe losses, check several areas of each field carefully. Check thick, lodged areas first because armyworm moths prefer dense, lush stands of vegetation for egg laying. Shake several plants vigorously and check the soil surface, under plant debris, and under soil clods for the presence of larvae. If you find no larvae in these denser areas the odds are good that there are no heavy infestations in the rest of the field. On the other hand, if you do find larvae in these potential trouble spots it is necessary to carefully search the rest of the field. This process requires careful searching because early damage is hard to detect and the nocturnal feeding habits of the armyworm itself makes it hard to detect. When the armyworms decide to "march" they become very obvious because of their numbers and

because this will occur at anytime during day or night. Numbers can also be so great that their crushed bodies make highways slippery.

Remember that small armyworms are hard to locate and look nothing like the fully-grown larvae. Small armyworms are white to pale green, have a definite dark head, three pair of small 'true' legs just behind the head, and 5 pair of fleshy legs (called prolegs) near the rear of their bodies. Until they are about one-half grown, the armyworms will move with a "looping" motion.

There is a species of sawfly whose coloration is almost identical to that of a fully grown armyworm. You will find them on the leaves during the day, which is not typical behavior for armyworms, and they will always have 6 or more pairs of abdominal prolegs (small, unsegmented, fleshy and leg-like appendages) along the abdomen, just behind the three pairs of "true" legs. Armyworms have 4 pairs of abdominal prolegs and one pair on the anal segment. This sawfly larva is not a threat to any of our small grain crops.

### **Economic thresholds**

Examine the soil between two rows at several points in the field and determine the number of armyworms per square foot. When the population reaches 3 larvae per square foot, an insecticide application is justified.

### **Control**

Consult UW Extension Bulletin "Pest Management if Wisconsin Field Crops" A3646 for control recommendations. This bulletin maybe purchased from your local county extension office or is available to view, purchase or download from UW Cooperative Extension's The Learning Store at <http://learningstore.uwex.edu/>

---

## **Cereal Leaf Beetle**



### **Description**

First identified in Michigan and Indiana in 1962, it was detected in Walworth County, Wisconsin in 1971. Although it is uncommon in Wisconsin and has not reached economic proportions, it is advisable for field scouts to routinely check for its presence.

The adult is an attractive 3/16 inch long beetle that has a reddish-orange thorax and blue body. Eggs are readily seen on small grain foliage. They are 1/10 inch long and yellow in color when newly deposited, and are either laid singly or in short chains on the upper surface of grain crops. Lady beetle eggs are about the same size and color but they stand on end. Larvae are yellow grubs, and usually are covered with their own dark fecal material.

## Life cycle

Adults overwinter in hollow grain stubble and weed stems, in corn debris and under tree bark. Survival is best among individuals located below the snow line. When spring temperatures exceed 60 °F, the adults move to wild grasses, then to winter grains and finally oats. Eggs are laid on the leaf blade and hatch in approximately five days. Larvae require another 10 days for development. Pupation takes place in the soil and adult emergence approximately 20 days later. These adults feed briefly on corn and other foliage but then go into diapause (physiological arrestment) from July until the following spring. There is only one generation each year.

## Damage

Both adults and larvae can damage small grain foliage. The adults make longitudinal slits between the veins, and completely through the leaf, while larvae eat only the outer surface of leaves. A damaged field has a silver cast and appears frosted. Peak larval feeding may be expected in early June in southern Wisconsin, if we ever develop economic infestations. High populations can kill a small grain stand.

## Economic thresholds

Because we have had no economic infestations in the past there are no thresholds set for Wisconsin. However, Michigan State University offers the following suggestion to determine when spraying is needed:

1. Grain has not reached boot stage and there is a total of three or more eggs and larvae per stem, or
2. Grain is heading and there is one or more larvae per flag leaf.

---

# Wireworms



## Description

Wireworm larvae are copper colored and wire-like. When fully grown they are approximately one inch long. Adults are dark colored beetles commonly known as click beetles.

## Life cycle

Many species have a four-year life cycle. Eggs are laid in the soil of grassy fields during June and the resulting larvae feed on grass roots. They move below the frost line during winter and return to the soil surface the next spring. Two more winters are passed in the larval stage and finally in the fourth summer the insects pass through a pupal stage to become adults. This stage passes the fourth winter.

## **Damage**

Oats is the only small grain attacked by wireworms and this is only in the Spencer-Alamena soil of west-central Wisconsin. This soil has a hardpan at approximately nine inches and the surface soil tends to remain wet. Wireworms tend to be attracted to such soil for egg laying. When an infested field is plowed and seeded, the wireworms move into the row and attack the underground portions of seedling plant stems. This attack becomes apparent with the presence of dying and dead plant tops at scattered sites within a field.

## **Scouting suggestions**

Because there are no control methods, scouting is of questionable value. Fortunately, damage to small grains has been limited in recent years.

## **Economic thresholds**

None established. Growers will observe the larvae while plowing and these infestations are often spotty. As many as 48 wireworms per square foot have been noted near Marshfield.



# Wheat and Barley Disease Management

Wisconsin was a major wheat producing state in the 1800's. However, wheat gave way to corn and forages and Wisconsin's dairy industry. However, in recent years, wheat has made a modest comeback, especially in eastern Wisconsin. Wheat diseases are definitely a major production problem. Diseases such as leaf rust, powdery mildew, loose smut, take-all and barley yellow dwarf are recognized as potential problems. Septoria leaf blotch is becoming more of a factor as the intensity of wheat production increases. Winter wheat makes up most of Wisconsin's wheat crop, but spring wheat is grown in northwestern Wisconsin.

Barley is not a major field crop in Wisconsin. However, disease problems do occur on the few acres that are planted in Wisconsin. Similar diseases develop in barley as those in wheat. Symptoms, disease cycles and controls are identical in most cases.

## Disease Profiles

---

### Leaf rust and stem rust



Leaf rust and stem rust are two separate diseases of wheat. Leaf rust is caused by the fungus *Puccinia recondita* f. sp. tritici which only infects wheat. Stem rust is caused by the fungus *Puccinia graminis* f. sp. tritici. The wheat stem rust fungus is a specialized strain that only infects wheat. However, symptoms are similar to stem rust of other small grains.

#### Symptoms

Leaf rust is recognized by oval pustules which are orange and primarily are located on the leaves. Pustules of stem rust are cinnamon to brick red, more elongated and more commonly are observed on stems and leaf sheaths.

## Disease cycle

Spores of both the leaf rust and stem rust fungus are carried to Wisconsin by wind each year. Both fungi survive on winter wheat in Texas and Mexico during the winter months. Once inoculum arrives, moderate air temperatures and prolonged leaf wetness favor infection. Both pathogens produce abundant spores and spread from plant to plant and field to field. The leaf rust fungus can survive on winter wheat plants during the winter months if snow cover is early and continuous.

## Control

Most wheat varieties are resistant to prevalent races of the stem rust fungus. However, this is not the situation for leaf rust.

Early planting spring wheat can result in avoiding problems with leaf rust and stem rust. Both fungi do not readily survive in Wisconsin because their alternate hosts are rare.

Foliar fungicides are registered for rust control.

---

# Loose Smut of Wheat



Loose smut is caused by the fungus *Ustilago tritici*. Loose smut is always a threat to wheat production in Wisconsin. The smut fungus completely replaces all the grain in individual heads with its spores. Thus, yield loss is directly related to the percentage of diseased heads.

## Symptoms

Loose smut symptoms are obvious after the heads emerge. Diseased heads are black as the grain is replaced with the black spores of the smut fungus. The spores are dislodged and eventually only a bare stalk remains of what should have been a normal appearing head. Problems do occur on the few acres that are planted in Wisconsin.

## Disease Cycle

The smut fungus infects the wheat head at flowering. The fungus invades the embryo of the seed and causes no further destruction. Spores from infected heads provide the inoculum for infection. Infected seeds show no visible symptoms. Infected seeds are planted the next year and the fungus progresses from the embryo into the growing point of the plant. The fungus replaces the grain as the head develops in the stem of the plant. At heading, the infected head exhibits the symptoms that were previously described.

## Control

1) Seed can be used from fields that showed less than 1% smutted heads without the risk of significant smut development. 2) Wheat seed certified by the Wisconsin Crop Improvement Association is grown using procedures that control loose smut. 3) Wheat varieties are available that are resistant to loose smut. 4) Fungicide seed treatment with fungicides that contain carboxin as an active ingredient is a very effective control measure.

---

# Barley Yellow Dwarf of Wheat



Barley yellow dwarf of wheat is caused by the barley yellow dwarf virus. This is the same virus that infects oats and causes red leaf. BYD is more of a problem on winter than spring wheat. Different problems arise because winter wheat is planted in the fall.

## Symptoms

For most varieties, leaves will turn yellow, usually starting at the tips. Some reddening may occur, but not as intensely as in oats. Good leaf symptoms develop if warm temperatures prevail. Plants may be stunted and plants exhibit a stiff, erect habit of the upper leaves. Leaves may also exhibit a long tapered appearance. Symptoms of BYD may be confused with yellowing caused by cool soil temperatures and nitrogen deficiency.

## Disease Cycle

BYDV is transmitted by aphids. Winter wheat is very prone for infection if aphids are active after planting in fall and vegetative growth is attractive to aphids. Aphids that acquire the virus from other hosts and move into winter wheat fields in the fall. Grasses and oats are believed to be main sources of the virus, but corn is a symptomless host and can serve as an additional source of the virus.

## Control:

1) Wheat varieties with moderate degree of resistance to BYDV are available. 2) Early planted spring wheat can avoid BYD problems like the situation for oats. However, winter wheat that is planted in late August or early September is very prone to BYD problems. Virus infected aphids may be active well

into September. If winter wheat is planted early, the crop may sustain enough vegetative growth that is attractive to aphids. BYD can be avoided by planting winter wheat after mid September in northern Wisconsin and late September in southern Wisconsin. 3) Aphid control with insecticides is available. However, this is an added expense. The cultural practices mentioned above provide a more practical control strategy.

---

## Head Blight or Scab of Wheat



Scab of wheat is manifested by the premature death or blighting of spikelets. The disease occurs on all small grains, but is most serious on wheat and barley. Significant yield losses result from floret sterility and poor seed development. The scab fungus may also infect other plant parts. Thus, damage to heads may coincide with root or leaf infection or associated with seedling blights when seed from scabby plants are planted in subsequent years.

### Symptoms

Scab is caused by the fungus *Fusarium graminearum* and is best recognized on emerged immature heads that are still green in color. Infected spikelets on the entire head may prematurely bleach. Small black structures called perithecia eventually become evident on blackened tissues. Pink to salmon or orange mycelium can be observed at the base of individual spikelets. Infected seed may be shriveled or appear normal.

Grain from scabby plants is usually less palatable by livestock and often contains mycotoxins produced by the scab fungus. The mycotoxin, zearalonone (F2) and vomitoxin frequently contaminate scabby grain. The scab fungus ceases to produce mycotoxins in storage if the grain moisture content is below 20%.

### Disease Cycle

The scab fungus survives on colonized wheat or corn debris. The scab fungus causes root rot, stalk rot and ear rot of corn. Thus, scab can be more of a problem when wheat is planted after corn or after wheat or barley. The scab fungus is commonly found in the soil, thus crop rotation is not always an effective control practice. Most wheat crops are unavoidably exposed to spores of the scab fungus. Infection occurs during moist warm weather. Blight symptoms develop within 3 days after infection when temperatures range from 75-85°F and moisture is continuous. Excessive wheat or corn debris left on the soil surface will increase the inoculum of the scab fungus and enhances the probability of severe scab development.

### Control

No highly-resistant wheat varieties are available, but small differences in susceptibility may exist.

Although the scab fungus is ubiquitous, crop rotations that avoid corn or small grains preceding the wheat crop can suppress scab development. Conventional tillage to bury crop residues is also recommended because the fungus survives best on the surface debris.

---

## Septoria Leaf Blotch

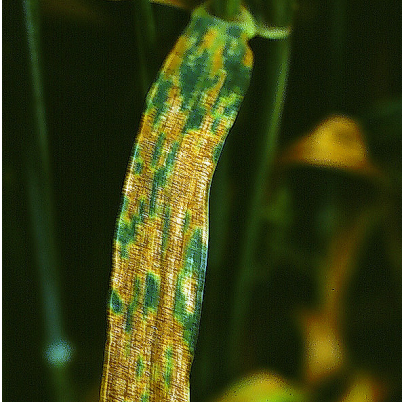

Septoria Leaf Blotch is caused by the fungus *Septoria tritici*. The disease is very prevalent in Wisconsin and is capable of causing a 30% reduction in yield.

### Symptoms

Small, light green-to-yellow spots on the leaves and sheaths enlarge and merge to form irregular, tan-to-reddish-brown blotches with gray-brown to ash-colored centers often partly surrounded by a yellow margin. Black specks (pycnidia) form in older lesions or at stem nodes. Affected leaves often turn yellow, wither and die early.

### Disease cycle

The fungus survives in living and dead wheat plants and in seed. Infections in the fall can serve as a major source of inoculum in the following spring. Spores are disseminated to new foliage by wind and rain. Disease development is favored by moderate air temperatures and prolonged leaf wetness.

### Control

1) Wheat varieties differ in susceptibility. 2) Crop rotation offers some control. If wheat is planted in fields that were cropped to wheat the previous year, deep incorporation of wheat residues offers some control. 3) Apply foliar fungicides at the boot stage to protect the flag leaf of plants.



---

# Powdery Mildew



Powdery Mildew is caused by the fungus *Erysiphe graminis* f. sp. *tritici*. The disease is common in Wisconsin, but lacks the destructive potential like that of leaf rust and *Septoria* leaf blotch.

## Symptoms

White-to-light gray, powdery patches form on the leaves, sheathes, stems and floral bracts. Black, speck-sized cleistothecia form in the mildew growth as the crop matures. Spores are produced in cleistothecia that serve as primary inoculum the following year. When severe, infected leaves wither and die early. Mildew can develop on wheat heads and is an indication that significant yield loss will likely occur.

## Disease cycle

The fungus overseasons on living and dead plants. Spores are produced and spread to leaves. Infection is favored by cool and moist conditions. Periods of hot and dry weather are very suppressive for the disease. Spores are readily produced and disseminated during favorable conditions resulting in sudden and severe outbreaks of the disease.

## Control

1) Wheat varieties differ in susceptibility. 2) Apply foliar fungicides if the disease is present on lower leaves and the plants are reaching the boot stage.

# Contents

## Chapter 6: Nutrient Management

### Nutrient Management Fundamentals

Nutrient Management Practices for WI Corn Production & Water Quality Protection (UWEX A3557)

Sampling Soils for Testing (UWEX A2100)

Optimum Soil Test Levels for Wisconsin (A3030)

Soil and Applied Nitrogen (UWEX A2519)

Soil and Applied Phosphorus (UWEX A2520)

Soil and Applied Potassium (UWEX A2521)

**Plant Nutrient Deficiency Symptoms**

**Nutrient Deficiencies and Application Injuries in Field Crops Bulletin**

Sampling for Plant Analysis (UWEX A2289)

### Nutrient Management Planning

Nutrient Management Standard 590: Criteria Summary - ver. 7/02

**Nutrient Management Standard 590: Full Version**

A Step by Step Guide to Nutrient Management (UWEX A3568)

**What is a Farm Nutrient Management Plan**

### Publications

Know How Much You Haul

**Nutrient Management Fast Facts**

**Soil Testing Basics**

Nitrogen Guidelines for Corn in Wisconsin

A3557

University of Wisconsin-Extension - Cooperative Extension  
College of Agricultural and Life Sciences, University of Wisconsin - Madison

# *Nutrient Management*

*Practices for Wisconsin Corn Production and Water Quality Protection*



## *Introduction*

Soil nutrients, like all agricultural inputs, need to be managed properly to meet the fertility requirements of corn without adversely affecting the quality of our water resources. The corn nutrients of greatest concern relative to water quality are nitrogen (N) and phosphorus (P). Nitrogen not recovered by a corn crop can contribute nitrate to groundwater through leaching. Nitrate is the most common groundwater contaminant found in Wisconsin, and the United States as a whole. Nitrate levels that exceed the established drinking water standard of 10 ppm nitrate-N have the potential to adversely affect the health of infants and livestock. Surface water quality is the concern with P management. Erosion and runoff from fertile cropland add nutrients to surface waters that stimulate the excessive growth of aquatic weeds and algae. Of all crop nutrients, P is the most important to prevent from reaching surface water since the biological productivity of aquatic plants and

algae is most limited by its availability. Consequences of increased aquatic plant and algae growth include the depletion of dissolved oxygen contents of lakes resulting in fish kills, as well as reduced aesthetic and recreational values of lakes.

Appropriate nutrient management practices for corn production vary widely due to cropping, topographical, environmental, and economic conditions. With the variety of factors to consider in corn fertility management, it is nearly impossible to recommend best management practices applicable to all Wisconsin farms. Nutrient management practices for preserving water quality while maintaining or improving farm profitability must be tailored to the unique conditions of individual farms. A number of options for improved nutrient management are available to Wisconsin corn growers and are discussed in this publication.

## *Nutrient Application Rates*

The most important consideration in sound nutrient management for corn production is application rate. Nutrient applications in excess of crop needs are unwise from both an environmental and economic viewpoint. Applications of N greater than corn requirements increase the potential for nitrate leaching to groundwater. Similarly, over-applications of P can increase the detrimental impacts of cropland runoff and erosion on surface water quality.

Soil nutrients removed from cropping systems via leaching or erosion are investments lost by the grower. However, soil nutrient levels that are inadequate to meet the requirements of a crop often result in yields below those needed for reasonable profit. Because of the overall importance of nutrient application rates, accurate assessments of corn nutrient needs are essential for minimizing threats to water quality while maintaining economically sound production. Soil testing is imperative in the accurate determination of supplemental fertilizer requirements of corn.

### *Wisconsin Soil Test Recommendations*

The importance of a regular soil testing program has long been recognized by most corn growers. The goals of Wisconsin's soil testing program are to determine existing levels of available soil nutrients and recommend fertilizer applications to prevent any nutrient deficiency which may hinder crop production. Proper soil testing will give a relative index of soil supplied nutrients and nutrients previously supplied from manure, legume crops or commercial fertilizer. When the nutrient supply drops below a "critical" level for a particular soil and crop, yield reduction will occur. Since nutrient demands are not uniform throughout the entire growing season, an adequate supply must be planned for the period of peak demand. Supplemental fertilizer applications based on soil test results allow the nutrient demand to be met. As farmers apply increasing amounts of nutrients, and as soil fertility levels increase, water quality problems associated with excess nutrients may become evi-



dent. At this point, soil tests are needed to keep soils within optimum nutrient supply ranges.

The Wisconsin soil testing program is research-based, reflects environmental concerns, and recognizes the need for profitability in crop production. Soil testing has some limitations, but it is the best available tool for predicting crop nutrient needs. Nutrient application recommendations can only be accurate if soil samples representative of the field of interest are collected. Complete instructions for proper soil sampling are included in UWEX publication A2100, *Sampling Soils for Testing*. Samples that are unrepresentative of fields often result in recommendations that are misleading. In addition, field history information must be provided with the soil samples in order to accurately adjust the fertility recommendations to account for nutrient credits from field-specific activities such as manure applications and legumes in the rotation.







**Table 1. Nitrogen recommendations for corn.**

See Nutrient Management Fast Facts for updated information.

Soil N (%)	Sands and loamy sands		Other soils	
	Irrigated	Non-irrigated	Medium and low yield potential <sup>1</sup>	Very high and high yield potential <sup>1</sup>
	----- (lbs N/a) -----			
< 2.0	200	120	150	180
2.0 – 9.9	160	110	120	160
10.0 – 20.0	120	100	90	120
> 20.0	80	80	80	80

<sup>1</sup> To determine soil yield potential, see Table 16 of UWEX bulletin A2809, **Soil Test Recommendations for Field, Vegetable, and Fruit Crops**, or contact your agronomist or county agent.

Users of the University of Wisconsin N recommendations should be aware of the relationship between increased returns from the use of N at rates needed for economic optimum yields and the risk of nitrate loss to groundwater. The data illustrated in Table 2 provide a typical example of the relationships among N rate, yield, profitability, and crop recovery of applied N. In this case, it is clear that yields and economic return increase up to the 160 lb N/acre rate. However, crop recovery of N decreases and the potential

for nitrate loss to the environment increases as N rates are increased to, and especially above, the economic optimum. Although the risk of nitrate loss to groundwater is lower at N rates below the economic optimum, yields and economic returns are also likely to be lower.

### Methods for Improving Nitrogen Recommendations

The recent development of soil tests for assessing soil N levels has provided new tools for improving the efficiency of N fertilizer applications to corn. Soil testing for N allows corn N recommendations to be adjusted for the numerous year and site-specific conditions that can influence N availability. Two soil N tests are currently available. One is a technique for assessing N requirements based on measuring the residual soil profile nitrate present before planting. The other is a pre-sidedress soil nitrate test that provides an index of N availability and predicts sidedress N requirements.

In humid climates such as Wisconsin, it had been assumed that N applied to crops was utilized, immobilized, or lost through leaching or denitrification prior to the following growing season. However, research has shown that in some years, significant amounts of residual nitrate remain in the root zone where it can be utilized by subsequent crops. Soil nitrate testing can determine the amount of nitrate-N that has “carried-over” from the previous growing season and is available to crops. Nitrogen fertilizer recommendations in fields where a soil nitrate test has been used can be reduced to reflect the soil’s residual nitrate content. Crediting residual nitrate not only reduces fertilizer costs; it also aids in reducing risks of nitrate movement to groundwater due to N application in excess of crop needs.

**Figure 2. The separation of very high/high and medium/low yield potential soils according to 2,300 growing degree day (GDD) accumulation and county boundaries (2,300 GDD = May 1 to Sept. 30, 50° base).**

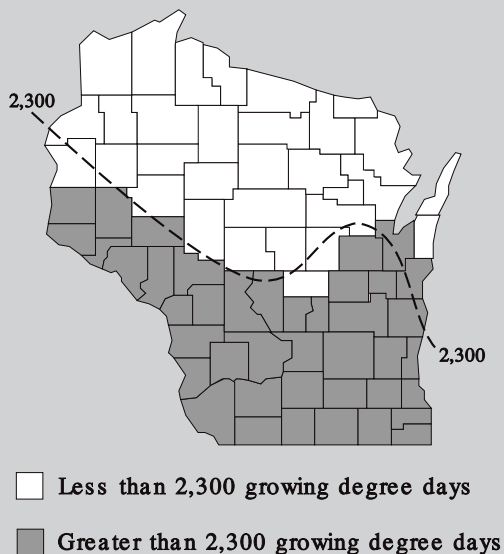

The potential for nitrate to remain in a soil profile from the previous growing season is affected by soil texture and precipitation amounts (Table 3). Generally, nitrate is more likely to accumulate on silt loam or heavier textured soils. Nitrate-N carry-over on sandy soils is not expected, and neither the preplant or pre-sidedress nitrate test is recommended on sands. The potential for nitrate carry-over is greatest when:

- ❑ precipitation during the previous growing season and over-winter period is normal or below normal
- ❑ the amount of previously applied N (including manure and legumes) was greater than the crop's need
- ❑ pest problems or climatic conditions limited crop uptake of N during the previous growing season.

#### Preplant Soil Nitrate Test

A preplant soil nitrate test involves deep soil sampling in the spring prior to both corn planting and any N applications. Soil samples need to be collected in one foot increments to a depth of two feet. Previously, the suggested sampling depth was three feet. The amount of nitrate-N in the third foot is now estimated based on the nitrate content in the top two feet—unless samples are taken to the three foot depth.

Early spring sampling measures only the nitrate form of N in the soil. Preplant soil nitrate test samples are usually collected too early in the growing season to measure N released from fall or spring manure applications, previous

legume crops, and soil organic matter. However, if background information on field management is provided with the soil samples, standard N credits for manure, legumes and organic matter are deducted from the N fertilizer recommendation. Because soil sampling occurs too early to measure the N contributions from legumes, the preplant nitrate test is most useful in years of corn following corn in a rotation. If corn follows a forage legume (alfalfa), the test is not needed; however, the standard N credit for the previous legume crop should be taken or the pre-sidedress soil nitrate test could be used.

Sampling procedures for the preplant soil nitrate test and information on sample handling are available from your local UWEX office, as well as in UWEX publication A3512 *Wisconsin's Preplant Soil Profile Nitrate Test*.

#### Pre-sidedress Soil Nitrate Test

The pre-sidedress soil nitrate test is another method available to corn growers for improving the efficiency of N applications. Unlike preplant soil nitrate test samples, soil samples for the pre-sidedress nitrate test are collected only to a depth of one foot when corn plants are 6 to 12 inches tall, usually four to six weeks after planting. Mineralization of organic N to the plant-available nitrate form has usually occurred by the time pre-sidedress samples are collected. Consequently, this soil test can measure the amount of N released from previous legumes, fall/spring manure applications, and soil organic matter as well as residual nitrate in the top foot of soil. The pre-sidedress soil nitrate test can be a valuable tool for growers wanting to confirm the amount of N credited from manure or previous legume crops.

**Table 2. Yield, economic return, and recovery of applied N with 40 lb/a increments of fertilizer N applied to continuous corn. Janesville, Wisconsin, 1983–85.<sup>1</sup>**

N rate (lb/a)	Yield (bu/a)	Value of yield increase (\$/a)	Return (\$/a)	N recovery in grain	
				Incremental (%)	Total (%)
0	93	—	—	—	—
40	115	44	38	45	45
80	131	32	26	45	40
120	138	14	8	20	37
160	144	12	6	17	32
200	145	2	-4	0	25

<sup>1</sup> Assumes \$0.15/lb for N and \$2.00/bu for corn.

**Table 3. Relative effects of soil texture, and previous growing season and over-winter precipitation on nitrate-N carry-over potential.**

Soil Texture	Precipitation		
	Below Normal	Normal	Above Normal
Sand	Low	Low	Low
Loam	High	Medium	Low
Silt loam, & finer	High	High	Low

Pre-sidedress nitrate test results are interpreted using a critical value of 21 ppm nitrate-N. Fields testing above 21 ppm N will most likely *not* respond to additional N. Fields testing below 21 ppm N will likely respond to additional N. Recent research showing a relationship between pre-sidedress test results and soil yield potential has improved



the usefulness of the test for determining N application rates at soil test levels below the critical value of 21 ppm N. Specific N rate recommendations for corn at various pre-sidedress test results are shown in Table 4.

Growers using the pre-sidedress rather than the pre-plant nitrate test have the advantage of a less labor-intensive sample collection procedure which can reduce the amount of time spent soil sampling. However, use of the pre-sidedress nitrate test may have some disadvantages to corn growers. Obviously, growers using the pre-sidedress test are locked into applying any supplemental N as a sidedress application. This removes some flexibility in the type of N fertilizer and fertilizer application method that can be used. An additional consideration when using the pre-sidedress test is time. Use of this test requires that soil sampling, laboratory analysis, and sidedress N applications all occur during a short period of time (one to two weeks) when a grower may be committed to other farm operations, such as cultivating, haying, etc.

Nitrogen recommendations based on either soil nitrate test are offered by University of Wisconsin labs in Madison and Marshfield and by several commercial soil testing labs. The names of commercial labs performing these tests are available from county UWEX offices.

**Table 4. Corn nitrogen recommendations based on the pre-sidedress soil nitrate test (PSNT).**

PSNT Result	Soil Yield Potential <sup>1</sup>	
	Very High/High	Medium/Low
N	N Application Rate	
--- (ppm) ---	----- (lb/a) -----	
≥ 21	0	0
20–18	60	40
17–15	100	40
14–13	125	80
12–11	150	80
≤ 10	160 <sup>2</sup>	120 <sup>2</sup>

<sup>1</sup> To determine a soil's yield potential, consult UWEX publication A2809, *Soil test recommendations for field, vegetable and fruit crops*, or contact your agronomist or county agent.

<sup>2</sup> Unadjusted nitrogen application rate.

## Phosphorus

Careful management of phosphorus (P) in corn production is essential for preventing nutrient enrichment of surface waters. Contributions of P to surface waters have been shown to increase with increasing rates of applied P. Fertilizer applications at rates higher than crop utilization are unwise from both an environmental and economic viewpoint. Using soil tests to determine crop P needs, setting realistic crop yield goals, and taking appropriate nutrient credits are techniques which will reduce environmental risk and increase economic benefits.

To avoid over-fertilization with P and other nutrients, fertilizer additions should be made according to soil test results. Regular and systematic soil testing is required for determining P application rates. The University of Wisconsin soil testing system recommends soil nutrient applications at levels which in combination with nutrients supplied by the soil result in the best economic return for the grower. This reliance on both soil-supplied and supplemental nutrients reduces threats to water quality by avoiding excessive nutrient applications. At optimum soil test levels, the recommended P and potassium (K) additions are approximately equal to anticipated crop removal and are needed to optimize economic return and maintain soil test levels in the optimum range. Additions of P and K at optimum soil test levels are *essential* to prevent reductions in yields and profits.

The soil test recommendation program de-emphasizes the former build-up/maintenance philosophy in favor of a better balance between environmental and economic con-

siderations. As a result, soil fertility levels have the potential to drop below economically productive thresholds in only a few growing seasons. To prevent this, soil test levels need to be monitored closely to detect changes in P and K status. It is recommended that soil tests be taken at least every three years and preferably every other year on sandy and other soils of low buffering capacity. Detailed information on soil test recommendations is available in UW-Extension publication A2809, *Soil Test Recommendations for Field, Vegetable and Fruit Crops*.

Optimum soil test levels for P and other nutrients for corn production in Wisconsin are given in Table 5. Corn fertilizer recommendations for P and K are based on yield goals and soil test results as shown in Table 6. Note that soil test levels for P and K are reported in parts per million (ppm).

### Realistic Yield Goals

As shown in Table 6, an important criteria in the recommendation of appropriate P and K application rates for corn is the determination of realistic yield goals. Yield goal estimates that are too low will underestimate P and K needs and could inhibit corn yield. Yield goal estimates that are too high will overestimate corn needs and will result in soil nutrient levels beyond those needed by the crop which could increase the likelihood for nutrient contributions to surface waters.

**Table 5. Optimum Wisconsin test levels for corn.**

Soil test	Medium & fine textured soils			Sandy soils	Organic soils
	Southern & Western	Eastern Red	Northern		
	----- (ppm) -----				
Available Phosphorus	11–20	16–20	13–18	23–32	23–32
Exchangeable Potassium	81–110	81–110	101–130	66–90	66–90
Calcium	600–1,000	600–1,000	600–1,000	400–600	600–1,000
Magnesium	100–500	100–500	100–500	50–250	100–500
Sulfur	30–40	30–40	30–40	30–40	30–40
Manganese	10–20	10–20	10–20	10–20	10–20
Zinc	3–20	3–20	3–20	3–20	3–20
Boron	0.9–1.5	0.9–1.5	0.9–1.5	0.5–1.0	1.1–2.0



Yield goals must be realistic and achievable based on recent yield experience. Estimates used to determine corn P and K requirements should be cautiously optimistic but not more than 10 to 20% above the recent average corn yield from a particular field. Yield goals 10 to 20% higher than a 3-to 5-year average yield are suggested because annual yield variations due to factors other than nutrient application rates (primarily climatic factors) are often large.

Critical to successful estimation of corn yield goals is the keeping of *accurate records* containing corn yields from specific fields. Absence of crop yield records can result in other, less reliable, estimates being used in the determination of corn P and K requirements. It is strongly recommended that growers develop or maintain accurate corn yield records. The information gathered from such records can increase production efficiency and minimize threats to water quality.

**Table 6. Corn fertilization recommendations for phosphate and potash at various soil test interpretation levels.**

Yield goal (bu/a)	Soil test interpretation <sup>1</sup>				
	Very Low <sup>2</sup>	Low <sup>2</sup>	Optimum	High	Excessively High <sup>3</sup>
	----- P <sub>2</sub> O <sub>5</sub> , (lb/a) -----				
71–90	60–90	50–70	30	15	0
91–110	70–100	60–80	40	20	0
111–130	75–105	65–85	45	25	0
131–150	85–115	75–95	55	25	0
151–170	90–120	80–100	60	30	0
171–190	100–130	90–110	70	35	0
191–220	105–135	95–115	75	40	0
	----- K <sub>2</sub> O, (lb/a) -----				
71–90	50–80	40–65	25	15	0
91–110	55–85	45–70	30	15	0
111–130	60–90	50–75	35	15	0
131–150	65–95	55–80	40	20	0
151–170	70–100	60–85	45	20	0
171–190	75–105	65–90	50	20	0
191–220	80–110	70–95	55	25	0

<sup>1</sup> Where corn is harvested for silage, an additional 30 lb P<sub>2</sub>O<sub>5</sub>/a and 90 lb K<sub>2</sub>O/a should be applied to the subsequent crop if soil tests are optimum or below.

<sup>2</sup> For phosphate, use the higher values on sandy or organic soils and lower values for other soils. For potash, use the lower values on sandy or organic soils and higher values for other soils.

<sup>3</sup> Use a small amount of starter fertilizer on soils that warm slowly in spring (a minimum addition is considered 5, 10, 10 lb/a of N, P<sub>2</sub>O<sub>5</sub>, and K<sub>2</sub>O, respectively).



## Nutrient Crediting

The best integration of economic return and environmental quality protection is provided by considering nutrients from all sources. In the determination of supplemental fertilizer application rates, it is critical that nutrient contributions from manure, previous crops grown in the rotation, and land-applied organic wastes are credited. Both economic and environmental benefits can result if the nutrient supplying capacity of these nutrient sources is correctly estimated. Economically, commercial fertilizer application rates can often be reduced or eliminated entirely when nutrient credits are properly assessed. Environmentally, the prevention of over-fertilization reduces potential threats to water quality. The use of appropriate nutrient credits is of particular importance in Wisconsin where manure applications to cropland and legume crop production are common.

### Manure

Manure can supply crop nutrients as effectively as commercial fertilizers in amounts that can meet the total N and P requirements of corn. In order to utilize manure efficiently, the application rate and nutrient supplying capacity need to be estimated. Guidelines for determining rates of application can be found in UWEX publication A3537, *Nitrogen Credits for Manure Applications*. The most effective method for gauging the nutrient content of manure is to have samples analyzed by a commercial or university laboratory. Large farm-to-farm variation can occur in nutrient content due to manure storage, handling, livestock feed, or other farm management differences. Unfortunately, laboratory analysis is not always convenient or available; in such instances, estimates of crop nutrients supplied by animal manures should be made. Table 7 summarizes the University of Wisconsin recommendations for average nutrient values of livestock manures common to the state.

As indicated in Table 7, not all the nutrients in manure are available in the first year following application. For example with N, manure contains both organic and inorganic N—only the inorganic form is immediately available for crop uptake. The available N contribution to corn from dairy manure is approximately 30-35% of the total N content of the manure in the first crop year. Additional amounts of nutrients are added to the soil in the second and third year following manure applications. Detailed information on the second and third year manure nutrient credits can be found in USDA-Natural Resources Conservation Service *Wisconsin Field Office Technical Guide—Sec. IV, Spec. 590*.

**Table 7. Average nutrient content from various manures.<sup>1</sup>**

	Animal Type <sup>2</sup>			
	Dairy	Beef	Swine <sup>3</sup>	Poultry
<b>Total Nutrient Content</b>				
<b>Nitrogen (N)</b>				
Solid (lbs/ton)	10	14	14	40
Liquid (lbs/1000 gal)	24	20	25	16
<b>Phosphate (P<sub>2</sub>O<sub>5</sub>)</b>				
Solid (lbs/ton)	5	9	10	50 <sup>4</sup>
Liquid (lbs/1000 gal)	9	9	23	10
<b>Potash (K<sub>2</sub>O)</b>				
Solid (lbs/ton)	9	11	9	30
Liquid (lbs/1000 gal)	20	20	22	12
<b>First Year Availability</b>				
<b>Nitrogen (N)</b>				
Solid (lbs/ton)				
<i>surface applied</i>	3	4	7	20
<i>incorporated</i>	4	5	9	24
Liquid (lbs/1000 gal)				
<i>surface applied</i>	7	5	13	8
<i>incorporated</i>	10	7	16	10
<b>Phosphate (P<sub>2</sub>O<sub>5</sub>)</b>				
Solid (lbs/ton)	3	5	6	30 <sup>4</sup>
Liquid (lbs/1000 gal)	5	5	14	6
<b>Potash (K<sub>2</sub>O)</b>				
Solid (lbs/ton)	7	9	7	24
Liquid (lbs/1000 gal)	16	16	18	10

<sup>1</sup> Values are rounded to the nearest pound.

<sup>2</sup> Assumes 24, 35, 20 and 60% dry matter for solid dairy, beef, swine and poultry manure, respectively. Assumes 6, 5, 3, and 3% dry matter for liquid dairy, beef, swine, and poultry manure respectively.

<sup>3</sup> Assumes a farrow-nursery indoor pit operation for swine liquid manure nutrient values.

<sup>4</sup> For turkey, use 40 lb/ton for total nutrient content and 24 lb/ton for first-year available nutrient content.

The Wisconsin soil test recommendations account for manure (and legume) nutrient credits when the appropriate field history information is provided with soil samples. The soil test report utilizes the standard nutrient credits from Table 7 unless specific manure analyses have been performed. For analyzed manure, 35 to 60% of the total N (depending on manure type), 55% of the total  $P_2O_5$ , and 75% of the total  $K_2O$  should be credited in the first year. The fertilizer adjustment for analyzed manure needs to be made by the individual farmer, consultant, etc. For more information on the nutrient value of manure, see UWEX fact sheet A3411, *Manure Nutrient Credit Worksheet* or A3537, *Nitrogen Credits for Manure Applications*.

Management recommendations for minimizing the threat of manure nutrient losses to surface and groundwater are described in the manure management section of this publication.

## Legumes

Legume crops, such as alfalfa, clover, soybeans, and leguminous vegetables, have the ability to fix atmospheric N and convert it to a plant-available form. When grown in a rotation, some legumes can supply substantial amounts of N to a subsequent corn crop. For example, a good stand of alfalfa can often provide all of the N needed for a corn crop following it in a rotation. An efficient nutrient management program needs to consider the N contribution of a legume to the next crop.

Table 8 lists the N credits currently recommended in Wisconsin for various legume crops. With forage legumes, stand density, soil texture, and cutting schedule affect the value of the N credit. Detailed information on legume-N crediting can be found in UWEX Publication A3517 *Using Legumes as a Nitrogen Source*.

Similar to the nutrient credits for manure applications, the Wisconsin soil test recommendations account for the

nutrient contributions from legumes, provided that rotation information is included with the soil samples submitted for testing.

## Whey and Sewage Sludge

Application of organic wastes such as whey and sewage sludge is common in certain areas of the state; however, the overall percentage of corn acres treated with organic wastes is relatively small. Nonetheless, the nutrient contributions from sludge and whey applications are often significant and need to be credited. Special management and regulatory considerations pertain to the land application of these and other organic waste materials. Detailed information on the nutrient values and management practices associated with sludge and whey applications to agricultural lands is available in UWEX publications R2779, *Sewage Sludge Wastes that can be Resources*, and A3098, *Using Whey on Agricultural Land—A Disposal Alternative*.

## Starter Fertilizer

A minimal amount of starter fertilizer is recommended for corn planted in soils slow to warm in the spring. For corn grown on medium and fine textured soils, a minimum application of 10 lb N, 20 lb  $P_2O_5$ , and 20 lb  $K_2O$  per acre is recommended as a starter fertilizer at planting. In most corn fields, all the recommended  $P_2O_5$  and  $K_2O$  can be applied as starter fertilizer. On soils with test levels in the excessively high range, starter fertilizer applications in excess of 10 lb N, 20 lb  $P_2O_5$ , and 20 lb  $K_2O$  per acre should be avoided. Any amount of N applied as starter fertilizer that exceeds 20 lb N/acre should be credited against the overall N recommendation.



**Table 8. Nitrogen credits for legume crops.**

<b>Legume Crop</b>	<b>N Credit</b>	<b>Exceptions</b>
<b>Forages</b>		
<i>First Year Credit</i>		
Alfalfa	190 lb N/acre for a good stand <sup>1</sup> 160 lb N/acre for a fair stand <sup>1</sup> 130 lb N/acre for a poor stand <sup>1</sup>	Reduce credit by 50 lb N/a on sandy soils <sup>2</sup>  Reduce credit by 40 lb N/acre if less than 8 inches of regrowth at time of kill
Red clover	80% of alfalfa credit	Same as alfalfa
Birdsfoot trefoil	80% of alfalfa credit	Same as alfalfa
<i>Second Year Credit</i>		
Fair or good stand	50 lb N/acre	No credit on sandy soils <sup>2</sup>
<b>Green manure crops</b>		
Sweet clover	80–120 lb N/acre	Use 20 lb N/acre credit if field has less than 6 inches of growth before tillage, killing frost, or herbicide application
Alfalfa	60–100 lb N/acre	
Red clover	50–80 lb N/acre	
<b>Soybeans</b>	credit of 40 lb N/acre	No credit on sandy soils <sup>2</sup>
<b>Leguminous vegetable crops</b>		
Peas, snap beans and lima beans	20 lb N/acre	No credit on sandy soils <sup>2</sup>

<sup>1</sup> A good stand of alfalfa (70–100% alfalfa) has more than 4 plants/ft<sup>2</sup>; a fair stand (30–70% alfalfa) has 1.5 to 4 plants/ft<sup>2</sup>; and a poor stand (< 30% alfalfa) has less than 1.5 plants/ft<sup>2</sup>.

<sup>2</sup> Sandy soils are sands and loamy sands.

## *Timing of Applications*



Timing of application is a major consideration in N fertilizer management. The period between N application and corn uptake is an important factor affecting the efficient utilization of N by the crop and the amount of nitrate-N lost through leaching or other processes. Obviously, loss of N can be minimized by supplying it just prior to the period of greatest uptake by corn. In Wisconsin this typically occurs in mid-June throughout July when corn is in a rapid growth and dry matter accumulation period. Applications at such times reduce the potential for N to leach from the root zone before plant uptake can occur. On sandy soils, this kind of timely application is essential. On medium and finer textured soils, N leaching losses during the growing season are significantly less. Other factors including soil, equipment, and labor, are involved in determining the most convenient, economical, and environmentally safe N fertilizer application period for corn.

In regards to P fertilizer management, application timing is not a major factor affecting water quality protection. However, applications of P on frozen sloping soils or applications just prior to likely runoff events should be avoided to prevent P contributions to surface waters.

### *Fall Versus Spring N Applications*

The advantages and disadvantages of fall N fertilizer applications have been discussed for many years. An increased risk of N loss during the fall and early spring needs to be weighed against the price and convenience advantages often associated with fall-applied N. The agronomic concern with fall N applications is that losses between application and uptake the following growing season will lower crop recovery of N and reduce corn yield. The environmental concern with fall application is that the N lost prior to crop uptake will leach into groundwater.

Fall to spring precipitation, soil texture, and soil moisture conditions influence the potential for fall-applied N losses. As a result, the relative effectiveness of fall N applications varies widely from one year to the next depending on climatic conditions. If a soil is wet in the fall, rain-fall may cause either leaching of nitrate in coarse soils or denitrification of nitrate in heavy, poorly drained soils. Long-term studies indicate that fall applications are usually less



effective than spring applications. Wisconsin research has shown fall applications on medium textured soils to be 10 to 15% less effective than the same amount of N applied spring preplant.

**For both agronomic and environmental reasons, fall applications of N fertilizers are not recommended on coarse textured soils or on shallow soils over fractured bedrock.** If fall applications are to be made on other soils, they should be limited to the application of only the ammonium forms of N (anhydrous ammonia, urea, and ammonium sulfate) on medium textured, well-drained soils where N losses through leaching or denitrification are usually low. Fall applications of N should also be delayed until soil temperatures are less than 50° F in order to slow the conversion of ammonium to nitrate by soil organisms. If fall applications must be made when soil temperatures are higher than 50° F, a nitrification inhibitor should be used. Studies have shown that nitrification inhibitors are effective in delaying the conversion of ammonium to nitrate when N is fall-applied. However, fall applications of N with an inhibitor are still not likely to be as effective as spring-applied N.

## Preplant N Applications

Spring preplant applications of N are usually agronomically and environmentally efficient on medium-textured, well drained soils. The potential for N loss prior to corn uptake on these soils is relatively low with spring applications. If spring preplant applications of N are to be made on sandy soils, ammonium forms of N treated with a nitrification inhibitor should be used. Likewise, nitrification inhibitors

**Table 9. Probability of corn yield response with sidedress versus preplant N application.**

Soil	Relative Probability
Sands & loamy sands	Good
Sandy loams & loams	Fair
Silt loams & clay loams:	
– well-drained	Poor
– poorly drained	Fair

should be used if spring preplant N is applied to poorly drained soils. Use of nitrification inhibitors reduces the potential for N loss compared to preplant applications without them; however, sidedress or split applications are usually more effective than preplant applications with nitrification inhibitors.

## Sidedress N Applications

Sidedress applications of N during the growing season are effective on all soils with the greatest benefit on sandy or heavy textured-poorly drained soils (Table 9). The efficiency of sidedress N applications can be attributed to the application of N just prior to the period of rapid N uptake by corn and a much shorter period of exposure to leaching or denitrification risks. Table 10 illustrates the higher yield

**Table 10. Effect of rate and time of N application on corn yield and recovery of applied N on sandy, irrigated soil. Hancock, Wisconsin, 1981–84.**

N Rate --- (lb/a) ---	Yield		N Recovery	
	Preplant	Sidedress <sup>1</sup>	Preplant	Sidedress
	----- (bu/a) -----		----- (%) -----	
0	38	38	—	—
70	88	105	50	73
140	120	136	44	64
210	132	143	40	49
Average	113	128	45	62

<sup>1</sup> Sidedress treatments applied six weeks after planting.





and crop recovery of N on sandy soils with sidedress applications. In these trials, use of sidedress N applications improved average N recovery over preplant applications by 17%. The use of sidedress or delayed N applications on sandy soils is essential for minimizing N loss to groundwater since unrecovered N on these soils will be lost through leaching. Sidedress N applications may also be of benefit on shallow soils over fractured bedrock.

Sidedressing N requires more management than preplant N applications. In order to maximize efficiency, sidedress N applications must be properly timed to provide available N during the maximum N-uptake period for corn which begins at about 6 weeks after planting and continues for an additional 4 to 6 weeks. Applications too late may result in lower yield and plant injury from root pruning and other physical damage.

### ***Split or Multiple N Applications***

Application of N fertilizer in several increments during the growing season can be an effective method for reducing N losses on sandy soils. However, a single well-timed sidedress application is often as effective as multiple applications. Ideally, split applications supply N when needed by the corn and allow for N application adjustments based on early growing season weather or plant and soil tests.

Where split or multiple applications are used, any preplant N additions should be minimized and most of the N should be applied just prior to expected crop use.

To be successful, the timing of application and placement of fertilizer materials are critical. Climatic factors, such as untimely rainfalls, may interfere with application schedules and could result in nutrient deficiencies. Split applications, as well as sidedress applications, also tend to be more time, labor, energy and equipment intensive than preplant N applications.

### ***Fertigation***

A common method for split or multiple N applications is via irrigation systems. Multiple applications of fertilizer N at relatively low rates (30-50 lb N/a) can be injected into the irrigation water and applied to correspond with periods of maximum plant uptake. Theoretically, this should make less N available for loss through leaching. The most common fertilizer applied in irrigation systems is 28% N solution because it is readily available and causes little or no equipment problems during injection to irrigation water. Anhydrous ammonia should not be used in sprinkler irrigation systems because it can cause precipitation of calcium in the water and loss of free ammonia to the atmosphere.

The success of fertigation systems is dependent on climatic factors and proper management. Fertigation should not be relied upon as a sole method of applying N in a cropping season for the following reasons:

- ❑ Adequate rainfall during the early growing season could delay or eliminate the need for irrigation water. A delay in fertilizer application could reduce yields dramatically.
- ❑ Leaching can result if N is applied through an irrigation system at a time when the crop does not need additional water.
- ❑ All N applications need to be made prior to the crop's period of major N uptake. If applied later, little of the applied N will be used and leaching potential will be increased.

It also needs to be noted that the potential for back-siphoning of N into the well exists with fertigation. Wisconsin law requires anti-siphoning check valves to be in place on irrigation systems; however, if the guards are not properly installed, maintained, or not in place at all, fertigation systems could directly contribute to groundwater contamination.

## Nitrification Inhibitors

Nitrification inhibitors are used with ammonium or ammonium-forming N fertilizers to improve N efficiency

**Table 11. Relative probability of increasing corn yield by using nitrification inhibitors.**

Soil	Time of N Application	
	Fall	Spring Preplant
Sands & loamy sands	— <sup>1</sup>	Good
Sandy loams & loams	Fair	Good
Silt loams & clay loams		
– well-drained	Fair	Poor
– somewhat poorly drained	Good	Fair
– poorly drained	Good	Good

<sup>1</sup> Fall applications not recommended on these soils.

Note: Likelihood of response to inhibitor with spring sidedress N applications is poor.

**Table 12. Effects of nitrification inhibitor on corn yield and recovery of applied N, Hancock, Wisconsin, 1982–84.**

N-Serve Rate	Yield <sup>1</sup>	N Recovery
(lb/a)	(bu/a)	(%)
0	87	29
0.5	99	43

<sup>1</sup> Average of three N rates (70, 140, 210 lb/N/a).

and limit losses of fertilizer N on soils where the potential for nitrate leaching or denitrification is high. Nitrification inhibitors function by slowing the conversion of ammonium to nitrate, thereby reducing the potential for losses of N that occur in the nitrate form. At this time nitrapyrin (N-Serve) is the only nitrification inhibitor registered for use in Wisconsin.

The effectiveness of a nitrification inhibitor depends greatly on soil type, time of the year applied, N application rate and soil moisture conditions that exist between the time of application and the time of N uptake by plants. Table 11 gives relative probabilities for obtaining a corn yield increase when using a nitrification inhibitor in Wisconsin based on soil type and time of application.

Research has shown that the application of nitrification inhibitors on coarse textured, irrigated soils has the potential to increase corn yield and total crop recovery of N (Table 12). It should be noted that responses to inhibitor use on coarse-textured soils usually occur with spring preplant N applications. However, fall applications of N with an inhibitor on coarse textured soils are not recommended because the present inhibitors do not adequately control nitrification on these soils over such an extended period of time. As indicated previously, sidedress N applications are likely to be more effective on these soils. It is unlikely that sidedress applications of N will benefit from the use of a nitrification inhibitor due to the short period between application and uptake. Nitrification inhibitors have been shown to give a positive response on corn yield when used with fall or spring preplant N applications on heavy textured, poorly drained soils.

Careful management of N fertilizers even with the use of a nitrification inhibitor is required. Nitrapyrin is volatile and requires immediate incorporation. Also, fall applications of N when soil temperatures are above 50° F may result in accelerated degradation of the inhibitor which will reduce the potential for improved N recoveries.

## Soil Nutrient Placement

Placement of soil nutrients on agricultural fields can be a factor in determining their potential to affect water quality. Nutrient placement is a more important consideration with respect to P management and surface water quality protection than with N and groundwater quality.

### Nitrogen

The concern with N placement focuses more on preventing N loss through ammonia volatilization than movement to groundwater. Applications of N in the form of urea or N solutions need to be incorporated by rainfall, irrigation, injection or tillage. The amount of volatilization that occurs with surface N applications depends on factors such as soil pH, temperature, moisture, and crop residue cover. Minimal volatilization losses of N can be expected if spring surface applications are incorporated within 3 to 4 days—provided temperatures are low (<50°F) and the soil is moist. However, a late spring or summer application should be incorporated within a day or two because higher temperatures and the chance of longer periods without rainfall could lead to significant N volatilization losses. Recent research shows that losses may be as high as 20% under these conditions.

### Phosphorus

The placement of P-containing materials directly influences the amount of P transported to lakes and streams by surface runoff. If P inputs are broadcast on the soil surface and not incorporated, P levels of runoff waters can rise sharply. Phosphorus is strongly bound to soil particles; however, adequate soil-P contact must occur to allow for adsorption. Incorporation by tillage or subsurface band placement is a very effective means of achieving this contact. Wisconsin studies have shown that eroded sediment and runoff from soil surfaces where P fertilizer was not incorporated will contribute significantly higher amounts of P to runoff and have a greater potential for impact on surface water quality than from soil surfaces where P was incorporated.

To avoid enriching surface waters with soil nutrients, it is recommended that annual fertilizer applications for corn be band-applied near the row as starter fertilizer at planting. Annual starter applications of P can usually supply all of the P required for corn. This practice reduces the chance for P enrichment of the soil surface and reduces P loads in runoff from cropland. In addition, research has shown row applications of starter fertilizer can increase corn yields on most soils. Band fertilizer placement should be 2 inches to the side and 2 inches below the seed. Rates of application should be monitored closely if placement is closer to the seed.

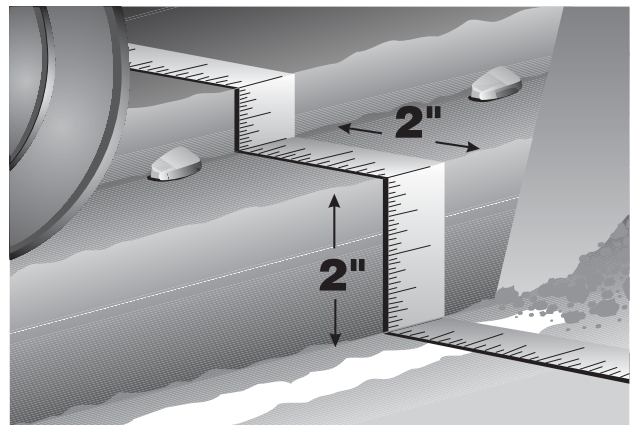

When large broadcast P fertilizer applications are needed to increase low soil P levels, these applications should always be followed by incorporation as soon as possible.



## *Manure Management*

Manure is a valuable resource. Manure applications to cropland provide nutrients essential for crop growth, add organic matter to soil, and improve soil structure, tilth, and water holding capacity. As with other nutrient sources, improper use of manure can result in environmental damage. The major concerns associated with manure applications are related to its effects on surface and groundwater quality. In regards to groundwater, the nitrate-N contribution of manure is of greatest concern. The likelihood of nitrate reaching groundwater is increased if manure applications exceed crop N needs, N contributions to soil from manure applications are not credited in fertilizer recommendations, or manure is improperly stored or handled. With surface waters, P is the manure nutrient of importance. Runoff from manured fields can carry readily available soil nutrients to surface waters. The high soluble P content of manure can have immediate adverse effects on surface water quality by enhancing production of algae and aquatic plants, and decreasing dissolved oxygen levels.

### *Application Methods*

Proper manure application techniques are very important for reducing contributions of P to surface waters. Agronomically, proper application of manure is important in preventing losses of N through the volatilization of ammo-

nia. Both nutrients can be conserved by incorporating or injecting manure. To protect surface water quality and reduce volatilization losses, it is recommended that surface-spread manure be incorporated within three days of application. Incorporation should reduce nutrient loss provided the tillage is sufficiently deep and does not accelerate soil loss. If a reduction in soil erosion protection appears likely from the incorporation of manure on sloping lands, a form of reduced tillage should be used. All incorporation or injection should follow the land contour when possible. When the incorporation or injection of manure is not practical, manure spreading should be directed to fields that have runoff control practices in place and which do not discharge unfiltered runoff to streams and lakes.

### *Application Rates*

Two common strategies for manure application to cropland exist:

- a P management strategy, and
- a N management strategy.

If maximum nutrient efficiency is the goal, rates of manure application need to be based on the nutrient present at the highest level relative to crop needs. For corn, the nu-



trient is P. With this strategy, manure should be applied at a rate which will meet corn's requirement for P; additional N and potassium (K) are supplied from other nutrient sources as needed. A management strategy based on P dictates the lowest manure application rates but it is the least likely to result in degradation of water quality. It has the disadvantages of being inefficient with respect to labor, energy, and time, more costly, and may have limited practicality. This system is only possible where the farmer has adequate land to spread manure at the lower rates required for this strategy.

An alternative strategy for utilizing manure is to determine a rate of application which will fulfill the corn requirement for N. This strategy maximizes the rate of application but results in the addition of P and K in excess of corn nutrient needs. The N strategy is most commonly used since the amount of land available for application is often limited. While other environmental considerations may restrict the timing, location, and methods of application, corn N requirements are the major rationale for limiting rates with this method of utilization. The amount of available N in manure and soil can be determined by manure and soil analysis. In lieu of specific manure analysis, estimates of the amount of available nutrients from manure are given in Table 7.

A manure application strategy based on crop N requirement will lead to an accumulation of P with repeated applications. Excessive soil test levels of P can result in surface water quality problems in the event of runoff and soil erosion. When soil test levels for P reach **75 ppm**, manure applications should be reduced and P-demanding crops such as alfalfa planted. At P soil test levels of **150 ppm**, manure and other sources of P should be discontinued until soil test

levels decrease. Soil runoff and erosion control practices such as residue management, conservation tillage, contour farming and filter strips are strongly recommended on soils where P levels significantly exceed crop needs.

From strictly a water quality viewpoint, P soil test levels of 75 to 150 ppm may be too high for some agricultural sites. Soil test P levels lower than 75 ppm would significantly reduce threats to surface water quality and be adequate for most crop needs. However, with the average P soil test level of Wisconsin soils at approximately 46 ppm and P soil test levels from dairy operations approximately twice that level, a P soil test limit of 75 ppm is not realistic for livestock operations needing to dispose of animal waste. Additionally, a statewide recommendation limiting soil test levels at 75 ppm would fail to consider the diversity of the state's soils. For example, areas of sandy soils where the potential for runoff and water erosion is low, higher P soil test levels would most likely not pose a threat to surface water quality. A general recommendation for P soil test levels would be that in the absence of adequate runoff control and soil conservation practices on soils susceptible to runoff and erosion, P soil test levels of 75 ppm should not be exceeded.

For surface water quality protection, it is recommended that on fields where manure cannot be incorporated, no more than 25 tons/acre of solid dairy manure or its equivalent based on P content be applied annually. In long term cropping situations that preclude manure incorporation (i.e. continuous no-till corn) it is recommended that a cumulative total of not more than 25 tons/acre of solid dairy manure (or its equivalent in P-content) be applied over a 5-year period unless previously applied manure has been incorporated.





## Application Timing

Manure application timing is of greater concern in controlling P contributions to surface waters than nitrate movement to groundwater. Manure should not be spread on sloping lands any time a runoff producing event is likely. Unfortunately, runoff producing events are impossible to predict and the elimination of manure applications to sloping lands is seldom a practical consideration for landowners. The period of major concern is the late fall, winter, and early spring months. Manure applied on frozen ground has an increased likelihood for contributing nutrients to surface waters due to spring thaws and rains causing runoff.

If winter applications of manure must be made, the risk should be minimized to the greatest extent possible. Manure applications to frozen soils should be limited to slopes of less than 6%. Preferably these soils are cornstalk covered, roughly tilled, or protected from up-slope runoff.

If applications of manure to frozen soils with slopes of 6 to 12% must be made, conservation measures need to be in place in order to protect surface waters. Grassed waterways must be well-established and maintained. Terraces should be in place, if appropriate, or fields contoured and strip-cropped with alternate strips in sod. If fields are farmed on the contour, they should be protected with an adequate residue cover from the previous year's crop.

Manure should not be applied to frozen soils on slopes greater than 12%.

## Site Considerations

Most soils have a high capacity for assimilating nutrients from waste materials such as manure. Unfortunately, areas of the state exist where the soil is highly permeable or shallow over fractured bedrock. In such areas, groundwater problems from the application of manure can result. For shallow soils, manure should not be applied to soils less than 10 inches thick over fractured bedrock. Where soil cover is 10 to 20 inches thick, manure needs to be incorporated within three days of application to allow for maximum soil adsorption of nutrients. Manure should not be applied when these soils are frozen. The 10 to 20 inch recommendation is intended for livestock operations in limited areas of the state where such unique soil conditions exist.

Movement of mobile nutrients to groundwater is more likely on excessively drained (sandy) soils. Manure applications in early fall to fields where no actively growing crop is present to utilize the N, may allow for the conversion of organic N to nitrate which is then subject to movement by

leaching. Whenever possible, manure should not be applied to sands or loamy sands in the fall when soil temperatures are greater than 50° F (conversion of ammonium-N to nitrate-N is significantly reduced at soil temperatures below 50° F) unless there is an over-wintering cover crop present to utilize the N. In the absence of a cover crop, apply manure when soil temperatures are below 50° F.

The main site characteristics affecting nutrient contributions to surface waters are those that affect soil runoff and erosion. These include slope, soil erodibility and infiltration characteristics, rainfall, cropping system and the presence of soil conservation practices. Site related management practices dealing specifically with manure placement to protect surface water include:

- ❑ Do not apply manure within a 10-year floodplain or within 200 feet of lakes and streams unless incorporation follows as soon as possible—no later than 72 hours after application. Do not apply manure to frozen soils in these areas. The 200 foot set-back allows for buffer strips to slow runoff velocity and deposit nutrient and sediment loads. Do not apply manure to the soils associated with these land areas when they are saturated.
- ❑ Do not apply manure to grassed waterways, terrace channels, open surface drains or other areas where surface flow may concentrate.

## Manure Storage

During periods when suitable sites for land application of manure are not available (i.e., soils are frozen or seasonally saturated), the use of manure storage facilities is recommended. Storage facilities allow manure to be stored until conditions permit land application and incorporation. In addition, storage facilities can minimize nutrient losses resulting from volatilization of ammonia and be more convenient for calibrated land applications. With the exception of those systems designed to filter leachate, storage systems should retain liquid manure and prevent runoff from precipitation on stored waste. It is imperative that manure storage facilities be located and constructed such that the risk of direct seepage to groundwater is minimized. With regards to maximum nutrient efficiency and water quality protection, it is critical that appropriate application techniques and accurate nutrient credits of the manure resource are utilized when the storage facility is emptied.

## *Irrigation Management*



Irrigation has become a standard agricultural practice in the sandy regions of Wisconsin and in other areas where shallow groundwater is available. As a result corn production on these often droughty soils has been successful; however, water quality problems may be increasing. Over-irrigation or rainfall on recently irrigated soils can leach nitrate and other contaminants below the root zone and into groundwater. Irrigation systems management is an important practice to consider in protecting the quality of groundwater.

The N management practices previously described will not, by themselves, effectively reduce leaching on soils that are regularly over-irrigated. Excess water from irrigation or precipitation can cause nitrate movement below the root zone. Accurate irrigation scheduling during the growing season can reduce the risk of leaching losses. A good irrigation scheduling program that considers soil water holding capacity, crop growth stage, evapotranspiration, rainfall and previous irrigation in order to determine the timing and amount of irrigation water to be applied is essential. Irrigation amounts adequate to meet crop needs but less than

the amount needed to saturate the soil profile will allow for rainfall to occur without causing leaching or runoff.

To promote irrigation efficiency, the University of Wisconsin-Extension has implemented the Wisconsin Irrigation Scheduling Program (WISP). WISP uses a water budget approach to advise growers on appropriate irrigation frequencies and amounts. Parameters included in the program include those mentioned above. The program allows flexibility in irrigation scheduling due to variations in weather. Further information on WISP can be found in UWEX publication A3600, *Irrigation Management in Wisconsin—the Wisconsin Irrigation Scheduling Program (WISP)*.

## *Soil Conservation*



Land-use activities associated with modern agriculture can increase the susceptibility for runoff and sediment transport from cropland fields to surface waters. Consequences of cropland erosion include loss of fertile topsoil, accelerated eutrophication and sedimentation of surface waters, destruction of fish and wildlife habitat, and decreased recreational and aesthetic value of surface waters.

The key to minimizing nutrient contributions to surface waters is to reduce the amount of runoff and eroded sediment reaching them. Numerous management practices for the control of runoff and soil erosion have been researched, developed, and implemented. Runoff and erosion control practices range from changes in agricultural land management (cover crops, diverse rotations, conservation tillage, contour farming, contour strip cropping, etc.) to the installation of structural devices (diversions, grade stabilization structures, grassed waterways, terraces, etc.). These practices are effective in reducing contaminant transport to surface waters.

Despite the proven effectiveness of soil conservation practices in reducing nutrient loadings to surface waters, their effect on groundwater quality is unknown. Practices that reduce surface runoff by increasing soil infiltration may, in turn, enhance the movement of soluble agricultural chemicals through the soil profile to groundwater. Trade-offs between reducing runoff and protecting groundwater quality may exist. If such is the case, decisions weighing the impact of one resource versus another will need to be made. Research on the effects of soil conservation management practices on groundwater quality is limited and often contradictory. It is clear that these relationships require further investigation.



## *Crop Rotation and Selection*

The selection of crops to include in a rotation with corn has been shown to influence the movement of N through soil profiles and the transport of P to surface waters. Legumes and other crops that do not require supplemental N inputs can effectively “scavenge” N remaining in the soil from previous crops. Also, crops with low N fertilizer requirements used in sequence with crops that require high N inputs or inefficiently recover N can reduce the amount of N inputs applied over a number of years. On soils with excessively high P levels, including a P-demanding crop such as alfalfa in the rotation would help to draw down P levels, as well as reduce soil and runoff losses and P losses to nearby surface waters.

Legumes used in cropping rotations fix atmospheric N and serve as an organic source of N. However, legumes will utilize residual inorganic N from the soil in preference

to fixing N. Deeply rooted legumes such as alfalfa often utilize soil N located below the rooting depths of other crops such as corn. Alfalfa has the potential to root to depths greater than 18 feet and research has shown that nitrate is utilized by alfalfa from any depth where soil solution is extracted by its roots. The use of alfalfa in rotations appears to be a viable management alternative for removing nitrate from soils below the rooting depth of most crops.

The removal of subsoil nitrates by deeply rooted legumes such as alfalfa would most likely be of more significance on medium and heavy textured soils than on sands. Research has shown that N applied to sandy soils that is not utilized by the crop is often leached below rooting depths in less than one year. Thus, alfalfa following corn in a rotation on sandy soils will not be able to recover nitrate which has previously passed through the profile.

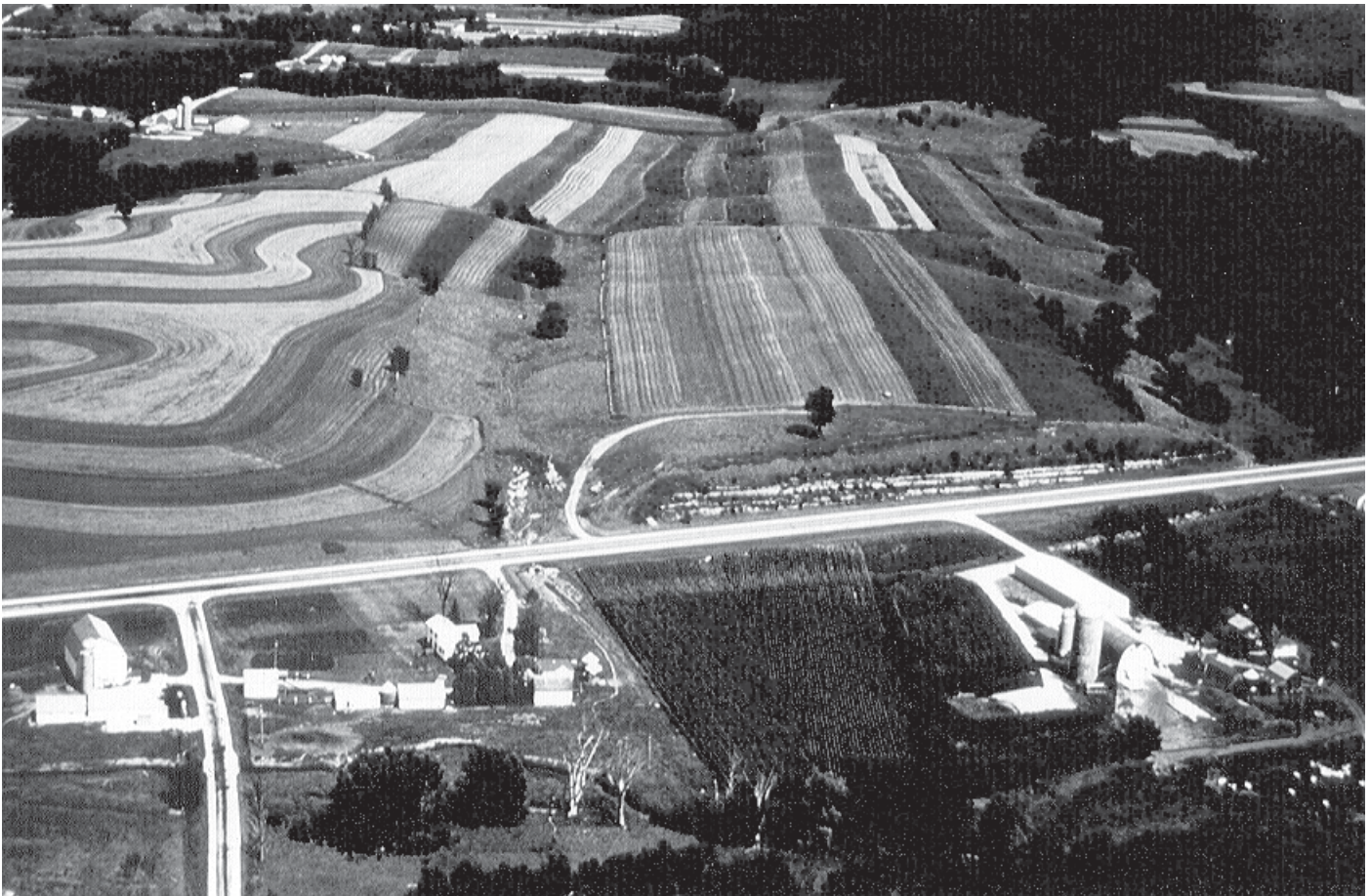



## *Filter Strips*



Maintaining or establishing strips of close-growing vegetation adjacent to water bodies is a practice that can reduce the sediment and nutrient content of runoff waters reaching them. The velocity of runoff is reduced when passing through a buffer strip as is its capacity for transporting sediment and nutrients. Sediment is deposited and runoff infiltrates or passes through the buffer strip with a substantially reduced nutrient content.

The width of an effective buffer strip varies with land slope, type of vegetative cover, watershed area, etc. Buffer strip dimensions need to be specifically designed for given field and cropping conditions. Local Land Conservation Department or Soil Conservation Service staff can assist landowners in establishing buffer strips.

Although proven effective in improving surface water quality, buffer strips may potentially have an adverse effect on groundwater quality. Increased infiltration in an area of sediment deposition may promote the leaching of soluble contaminants such as nitrate. The extent to which this may occur needs to be investigated and evaluated against the benefits to surface water quality.



## *Conservation Tillage*

### *Conservation Tillage and Fertilizers*

Conservation or reduced tillage systems, while being very effective in reducing runoff and soil erosion, require some degree of specialized nutrient management. This is particularly true for no-till systems of corn production. Research evaluating the effect of conservation tillage systems on nitrate movement to groundwater is limited. However, from a corn production standpoint, it is recommended that in addition to the standard N recommendation, an additional 30 lbs/acre of N be applied to continuous no-till and ridge-till corn production systems where residue cover after planting is at least 50%. This is needed to offset N that may be immobilized in surface residues and the lower annual amount of N mineralized from soil organic matter in high residue systems.

A great deal of research has investigated the effects of conservation tillage systems on P losses to surface waters. Recommended production practices for conservation tillage in Wisconsin fit well with surface water quality objectives. It has always been recommended that required fertilizer and lime be broadcast and incorporated prior to the implementation of a conservation tillage system. Annual fertilizer additions should be band-applied once the conservation tillage system is established.

### *Conservation Tillage and Manure*

Effective handling of manure is very important in protecting water quality. As mentioned earlier, nutrient additions to surface waters can be significantly reduced if land applied manure is incorporated. This is possible with most forms of reduced tillage but obviously not in no-till systems.

For both water quality and crop production purposes, manure applications to no-till cropland are not recommended. Research has shown that the P loadings to surface waters from manured no-till cropland can be extremely high. In addition, serious production problems can result from

the application of manure to no-till fields. A colder and wetter soil environment is created which can delay seed germination and the early growth of crops. Weed problems may also increase due to manure reducing herbicide activity and contributing weed seeds to the soil. Manure and the associated higher soil moisture content can also produce mechanical problems for planting equipment. Any or all of these conditions can cause serious production problems and reduce yields.

The problems presented with manure applications to no-till fields can be alleviated with light incorporation. After applications to no-till fields, manure should be lightly disked into the first two inches of soil. This will allow P to interact with soil particles and should reduce P contributions to runoff. In addition, the disking distributes manure more evenly and reduces the mechanical and soil temperature problems. This practice should not sacrifice erosion control because sufficient surface residues should still remain. While no longer strictly no-till, this modified practice is necessary to integrate the benefits of no-till and manure application.

Regardless of tillage, the practice of injecting manure at recommended rates with proper techniques can remove potential threats to surface water quality. Injection places soluble P in manure below the soil surface and maintains sufficient surface residue for runoff and soil erosion control in conservation tillage systems.



## *Conclusion*

This publication provides a brief summary of general nutrient management practices for Wisconsin corn production. It is not a complete inventory but rather an overview of soil fertility management options available to corn growers for improving farm profitability and protecting water quality. The selection of appropriate nutrient management practices for individual farms needs to be tailored to the specific conditions existing at a site.

Additional information on the topics discussed in this publication is available. Consult the following reference list for other publications on soil nutrient management practices. Advice on the applicability of these practices to individual farming situations can be gained from local University of Wisconsin–Cooperative Extension Service staff.



## References

- Bundy, L.G. 1985. Corn fertilization. Univ. Wis. Coop. Extn. Ser. Bull. No. A3340.
- Bundy, L.G. 1985. Understanding plant nutrients: soil and applied nitrogen. Univ. Wis. Coop. Extn. Serv. Bull. No. A2519.
- Bundy, L.G. 1987. Nitrogen management for groundwater protection and efficient crop use. Proceedings of 1987 Wis. Fert., Aglime & Pest Mgmt. Conf. 26:254-262.
- Bundy, L.G. 1988. Estimating nitrogen availability from soil and plant tests. Proc. 1988 Wis. Fert., Aglime & Pest Mgmt. Conf. 27:319-325.
- Bundy, L.G. 1989. Nitrogen management to protect groundwater resources. Ag Chem. Mgmt. Univ. Wis. Coop. Extn. Ser. Inservice Handbook.
- Bundy, L.G. 1989. The new Wisconsin nitrogen recommendations. Proc. Wis. Area Fert. and Aglime Dealer Meetings, Nov. 28 - Dec. 14, 1989.
- Bundy, L.G., T.W. Andraski, and P.C. Widen. Soil nitrate test results and corn N responses in 1989. Dept. of Soil Sci., Univ. Wis.-Madison. Mimeo.
- Bundy, L.G., K.A. Kelling, and L. Ward Good. 1990. Using legumes as a nitrogen source. Univ. Wis. Coop. Extn. Ser. Bull. No. A3517.
- Bundy, L.G., and E.S. Malone. 1988. Effect of residual profile nitrate on corn response to applied nitrogen. Soil Sci. Soc. Am. J. 52:1377-1383.
- Bundy, L.G., S.J. Sturgul, and K.A. Binning. 1994. Soil nitrate tests for Wisconsin cropping systems: A guide for using the preplant and pre-sidedress soil nitrate tests. Univ. Wis. Coop. Extn. Serv. Bull. No. A3624.
- Bundy, L.G., S.J. Sturgul, and R.W. Schmidt. 1990. Wisconsin's preplant soil profile nitrate test. Univ. Wis. Coop. Extn. Ser. Bull. No. A3512.
- Combs, S.M., E.E. Schulte, and L.G. Bundy. 1989. Summary of 1989 soil nitrate test results and outlook for 1990. Proc. 1989 Wis. Fert., Aglime, and Pest Mgmt. Conf.
- Council for Agricultural Science and Technology (CAST). 1985. Agriculture and groundwater quality. CAST Report No. 103. May, 1985.
- Curwin, D., and L.R. Massie. 1994. Irrigation management in Wisconsin-the Wisconsin irrigation scheduling program (WISP). Univ. Wis. Coop. Extn. Serv. Bull. No. A3600.
- Daniel, T.C., D.H. Mueller, B.J. Andraski, and R.E. Springman. 1989. Effect of tillage on erosion and runoff water quality. Univ. Wis. Coop. Extn. Serv. Bull. No. G3432.
- Daniel, T.C., R.C. Wendt, and F.W. Madison. 1979. Nonpoint pollution: sediment and phosphorus in agricultural runoff. Univ. Wis. Coop. Extn. Serv. Bull. No. G2966.
- Keeney, D.R., T.C. Daniel, and B. Shaw. 1986. Nitrate in Wisconsin groundwater: sources and concerns. Univ. Wis. Coop. Extn. Serv. Bull. No. G3054.
- Kelling, K.A., and A.E. Peterson. 1981. Using whey on agricultural land - a disposal alternative. Univ. Wis. Coop. Extn. Serv. Bull. No. A3098.
- Kelling, K.A., E.E. Schulte, L.G. Bundy, S.M. Combs, and J.B. Peters. The new Wisconsin soil test recommendation program: Vegetables. Proc. Processing Crops Conf. 20-22 Feb, 1990. LaCrosse, WI.
- Kelling, K.A., E.E. Schulte, L.G. Bundy, S.M. Combs, and J.B. Peters. The new Wisconsin soil test recommendation program: Forages. Proc. WI Forage Council Symp. 1990.
- Kelling, K.A., E.E. Schulte, L.G. Bundy, S.M. Combs, and J.B. Peters. 1991. Soil test recommendations for field, vegetable, and fruit crops. Univ. Wis. Coop. Extn. Ser. Bull. No. A2809.
- Hendrickson, L.L., D.R. Keeney, and L.M. Walsh. 1978. Evaluation of nitrapyrin as a means of improving nitrogen efficiency in irrigated sands. Agron. J. 70:689-703.
- Hendrickson, L.L., L.M. Walsh, and D.R. Keeney. 1978. Effectiveness of nitrapyrin in controlling nitrification of fall and spring applied anhydrous ammonia. Agron. J. 70:704-708.



- Jackson, G., D. Keeney, D. Curwen, and B. Webendorfer. 1987. Agricultural practices to minimize groundwater contamination. Univ. Wis. Coop. Extn. Serv. 115p.
- Leclerc, S. 1987. Effects of residual profile nitrate accumulation on corn response to applied N. M.S. Thesis. Dept. of Soil Sci., Univ. Wis.-Madison.
- Madison, F., K.A. Kelling, J. Peterson, T.C. Daniel, G. Jackson, and L. Massie. 1986. Managing manure and waste: guidelines for applying manure to pasture and cropland in Wisconsin. Univ. Wis. Coop. Extn. Serv. Bull. No. A3392.
- Magdoff, F.R., D. Ross, and J. Amadon. 1984. A soil test for nitrogen availability to corn. Soil Sci. Soc. Am. J. 48:1301-1304.
- Mathers, A.C., B.A. Stewart, and B. Blair. 1975. Nitrate-N from soil profiles by alfalfa. J. Environ. Qual. 4:403-405.
- Mueller, D.H., T.C. Daniel, and R.C. Wendt. 1981. Conservation tillage: best management practice for nonpoint runoff. Environ. Mgmt. 5(1):33-53.
- Mueller, D.H., R.C. Wendt, and T.C. Daniel. 1984. Phosphorus losses as affected by tillage and manure application. Soil Sci. Soc. Am. J. 48:901-905.
- Olsen, R.J., R.F. Hensler, O.J. Attoe, S.A. Witzel, and L.A. Peterson. 1970. Fertilizer nitrogen and crop rotation in relation to movement of nitrate-N through soil profiles. Soil Sci. Soc. Am. Proc. 34:448-452.
- Schulte, E.E., and A.E. Peterson. 1988. Using cover crops in sustainable agriculture. Dept. of Soil Sci., Univ. Wis.-Madison.
- Schulte, E.E., and L.M. Walsh. 1993. Management of Wisconsin soils. 4th ed. Univ. Wis. Coop. Extn. Ser. Bull. No. A3588
- Stewart, B.A., F.G. Viets, and G.L. Hutchinson. 1968. Agriculture's effect on nitrate pollution of groundwater. J. Soil Water Cons. 23:13-15.
- USDA-Soil Conservation Service. 1991. Wisconsin field office technical guide, Sec. IV-Spec. 590.
- Ward Good, L., F.W. Madison, K. Cates, and K.A. Kelling. 1991. Nitrogen credits for manure applications. Univ. Wis. Coop. Extn. Ser. Bull. No. A3537.
- Wis. Dept. Ag., Trade & Cons. Protection. 1989. Nutrient and pesticide best management practices for Wisconsin farms. WDATCP Tech. Bull. 1 - Univ. Wis. Coop. Extn. Ser. Bull. No. A3466.

---

Authors: Larry G. Bundy, Keith A. Kelling and Emmett E. Schulte are professors of soil science, University of Wisconsin-Madison and extension soil scientists, University of Wisconsin-Extension. Sherry Combs is director of the Soil and Plant Analysis Laboratory, University of Wisconsin-Extension. Richard P. Wolkowski is an outreach program manager in the Department of Soil Science, University of Wisconsin-Extension. Scott J. Sturgul is a senior outreach specialist with the Nutrient and Pest Management Program, University of Wisconsin-Madison. Desktop publishing: Kimberly Binning is an editor and Roger Schmidt is an information processing consultant with the Nutrient and Pest Management Program, University of Wisconsin-Madison.

Partial funding provided by the Wisconsin Department of Natural Resources - Nonpoint Source Priority Watershed Program.

This Publication is available from your Wisconsin County Extension office or from: Extension Publications, Cooperative Extension Publications, 45 N. Charter Street, Madison WI 53715. Phone (608) 262-3346 or (877) 947-7827 Contact Extension Publications to determine availability before publicizing.

An EEO/Affirmative Action employer, University of Wisconsin-Extension provides equal opportunities including Title IX and ADA requirements.

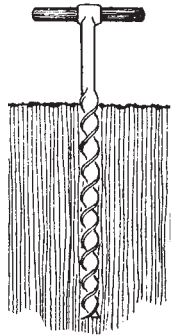

A2100

# Sampling soils for testing

John B. Peters, Carrie A.M. Laboski, and Larry G. Bundy

A soil test is the only practical way of determining whether lime and fertilizer are needed for a specific crop. However, if a soil sample does not represent the general soil conditions of the field, the recommendations based on this sample may be misleading. An acre of soil to a 6-inch depth weighs about 1,000 tons, yet less than 1 ounce of soil is used for each test in the laboratory. Therefore, it is very important that the soil sample is representative of the entire field. Before collecting soil samples, the overall approach of the nutrient management program should be determined. This will affect the number of samples needed and method by which samples will be taken. Specifically, will nutrient and lime applications be made at a single uniform rate for the whole field being tested or will applications be made at variable rates to field areas that have been identified as having different soil test levels?

## Goals of a soil sampling program

When sampling soils for testing and obtaining fertilizer and lime recommendations, the most common objectives are to:

1. Obtain samples that accurately represent the field from which they were taken.
2. Estimate the amount of nutrients that should be applied to provide the greatest economic return to the grower.
3. Estimate the variation that exists within the field and how the nutrients are distributed spatially.
4. Monitor the changes in nutrient status of the field over time.

## Selecting a soil sampling strategy

Before selecting the sampling strategy, consider analytical costs, time and equipment available, field fertilization history, and the likelihood of response to fertilization.

### Sampling fields for a single whole field (uniform) recommendation

With conventional sampling, you will receive a single set of nutrient and lime application guidelines that are based on sample averages. The sampling guidelines in Table 1 are based on when the field was last tested (more or less than 4 years ago) and whether the fields were responsive or non-responsive the last time they were tested. The responsive range is considered to be where either soil test phosphorus or potassium levels are in the high (H) category or lower. A non-responsive field is one where both soil test phosphorus and potassium levels are in the very high (VH) or excessively high (EH) categories.

Each sample should be made up of a minimum of 10 cores, to assure accurate representation of the nutrient needs of the field. Research has shown that taking 10–20 cores provides a more representative

sample of the area than when samples are made up of fewer cores. Use a W-shaped sampling pattern (as shown in Figure 1) over the whole area that is represented by the sample when gathering soil cores to make a composite sample. Be sure to thoroughly mix the cores before placing approximately 2 cups in the sample bag.

For best results, submit multiple samples for all fields. When at least three samples are provided, the Wisconsin nutrient application guidelines program will remove samples that are significantly higher than the field average and recalculate an adjusted average for the field. This ensures that no part of the field is under-fertilized. Where only one or two samples are submitted for a field, no sample can be discarded, whereas one sample can be discarded if three or four samples are submitted, and up to two samples may be discarded from fields having five or more samples. It is not appropriate to vary nutrient application rates across sampling areas when using this soil sampling scheme.

### Sampling fields for site-specific management

Site-specific management requires a distinct picture of the magnitude and location of soil test variability. Sampling

**Table 1.** Recommended sample intensity for uniform fields.

Field characteristics	Field size (acres)	Suggested number of samples <sup>a</sup>
<b>Fields tested more than 4 years ago OR fields testing in the responsive range</b>	All fields	1 sample/5 acres
<b>Non-responsive fields tested within past 4 years</b>	5–10	2
	11–25	3
	26–40	4
	41–60	5
	61–80	6
	81–100	7

<sup>a</sup> Collect a minimum of 10 cores per sample.



soils for site-specific management usually involves taking many more composite samples than sampling for a single recommendation. A global positioning system (GPS) is used to record the geographical coordinates of each sample. This information is used to generate an application map by using various mathematical techniques to interpolate the nutrient application rate between sampling points. Using variable rate application technology, these fields can be managed more intensively than the conventional approach of one fertilizer and lime rate per field. A careful evaluation of the economics of this intensive of a sampling system needs to be done before proceeding.

When using a site-specific approach to soil sampling, sample handling and testing are similar to the traditional system, but recommendations may vary from one part of the field to another, and these areas must be managed separately to realize the potential advantages of intensive soil sampling.

Several sampling strategies can be used to guide variable-rate fertilizer and lime applications. Grid sampling uses a systematic approach that divides the field into squares of approximately equal size (grid cells). The sampling technique used is known as grid-point sampling. A grid-point sample consists of at least 10 cores collected from a small area (10-foot radius) around a geo-referenced point. When using a grid sampling approach, Wisconsin research recommends a sampling strategy based on an unaligned systematic grid (Figure 2). Sampling points should be unaligned

because sampling in a uniform grid arrangement may lead to biased results if aligned with row patterns. Fields that have soil test phosphorus and potassium levels in the non-responsive categories should be grid-point sampled on a 300-foot grid. This is equivalent to one soil sample for every 2 to 2.5 acres. Where there is no information about the phosphorus or potassium status of the field or where previous tests were in the responsive range, a 200-foot grid size should be used. This is equivalent to approximately one soil sample per acre. These small grid cell sizes are needed to be able to adequately characterize the variability in soil fertility and are based on Wisconsin research. A larger grid cell size (such as 5 acres) may not adequately describe the field variability and may limit the potential economic benefits of site-specific management.

### Other considerations in selecting a sampling strategy

The sampling strategy selected must also be appropriate for the field size and topography.

**Contour strips** — On contour strip fields, sample each strip separately if it is approximately 5 acres or more in size, following the sampling intensity guidelines provided in Table 1. Cores from two or three small strips that have identical cropping and management histories may be combined following these same recommended sampling intensity

guidelines. Using a grid point sampling approach on contour strips or small fields is not appropriate, regardless of grid cell size. This is because a grid technique may result in many soil samples being collected from one contour strip, but none in other strips; additionally grid point samples may be on the edge of the strips and not adequately represent the strip.

**Five-acre grid point sampling** — The 5-acre grid point sampling system for whole field management recommendations has recently become popular with soil samplers because it takes less time to collect cores as compared to the traditional W pattern. Another advantage of this approach is its ability to track changes in soil test levels over time, because soil samples are collected from the same geo-referenced (GPS) point each time the field is sampled. Five-acre grid point sampling can likely be used in some situations, but not in others. For example, in fields that were soil sampled within the past 4 years and which were in the non-responsive range, averaging the soil test results from 5-acre grid point sampling is reasonable. This is because there previously had not been a fertilizer recommendation on these fields and some variability at excessively high soil test levels does not change the fact that no fertilizer was recommended. For fields that were sampled more than 4 years

**Figure 1.** Recommended W-shaped sampling pattern for a 15-acre field. Each sample should be composed of at least 10 cores.

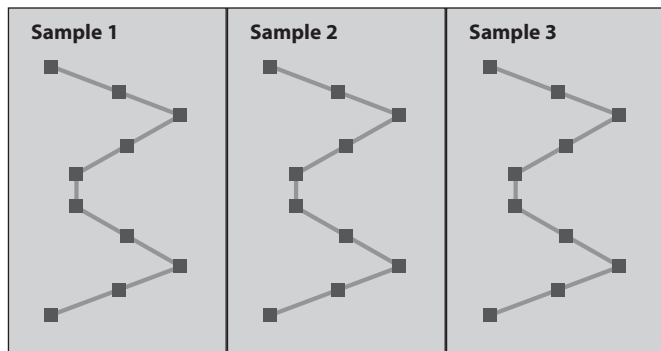

**Figure 2.** An example of an unaligned grid pattern for sampling site-specific fields.

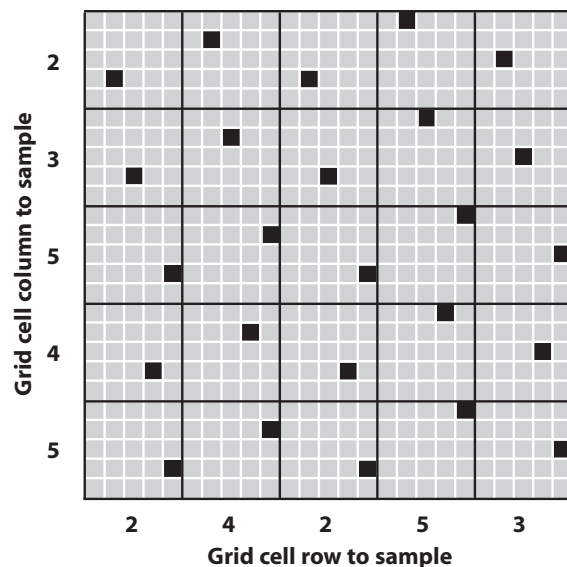

ago or where past soil test results were in the responsive range, 5-acre grid point sampling may not be the best choice of sampling techniques. This is because 5-acre grid point sampling may not adequately represent the variability within a field; and a comparatively small change in soil test level of 5–10 ppm could mean a large change in the amount of nutrients recommended. For small fields and contour strips, taking a few 5-acre grid point samples in each field and averaging them likely does not provide a very representative sample of the field. Additionally, the total number of samples may be small enough that none of them can be eliminated from the field average if it appears that one is an outlier.

#### **Smart (zone or directed) sampling** —

Another approach gaining support among researchers is smart sampling, also known as directed or management zone sampling. This approach uses information that has been collected using other precision agricultural technologies such as yield maps, aerial photographs of bare soil or crop canopy, or soil electrical conductivity measurements. Directed sampling evaluates the spatial distribution of several factors that may influence nutrient availability and crop productivity to help define sampling areas with similar characteristics. With previous comments in mind, either the W pattern or grid-point method can be used to collect samples within management zones. If the results of grid or management zone sampling do not warrant variable-rate application (for example, relatively little between-sample variation), average them to determine the appropriate single-rate treatment.

## **Procedures for taking soil samples**

### **When to take soil samples**

Take soil samples at any convenient time. Studies examining the effect of sampling time on soil test results suggest that test values for pH, phosphorus (P), and potassium (K) are typically slightly higher in early spring samples than in fall samples. To

receive your recommendations early enough to enable you to apply the lime and fertilizer needed, it may be best to sample in the fall. Another benefit of fall testing is that fertilizer prices are more likely to be discounted then. Hayfields can be sampled after any cutting. Regardless of when you sample, it is best to be consistent from one year to the next.

Winter sampling, or sampling when the soil is frozen, is permissible only when it is possible to take a uniform boring or core of soil to the appropriate depth. This may require using a portable power boring tool. Using a pick or spade to remove a few chunks of frozen soil from the surface will give inaccurate results.

### **How to take soil samples**

Certain government agency programs require nutrient management plans prepared according to the current USDA Wisconsin Natural Resources Conservation Service (NRCS) nutrient management standard (590). Soil sampling and testing procedures and nutrient application rates based on these soil tests must be consistent with the provisions of the 590 standard to be eligible for many cost-sharing programs. These provisions currently include following the soil sampling techniques just outlined and which are contained in Extension publication *Sampling Soils for Testing* (A2100), soil testing by a Wisconsin Certified Laboratory, and use of nutrient application rates consistent with the guidelines contained in this publication.

The following steps will help you take full advantage of the Wisconsin nutrient application guidelines and must be followed to be consistent with the 590 standard.

Use a sampling probe or auger to take samples. You can obtain these tools on loan from most county Extension offices or fertilizer dealers.

1. If manure or crop residues are on the surface, push them aside to keep from including them in the soil sample.
2. Insert the probe or auger into the soil to plow depth or at least 6 inches. To aid year-to-year comparisons, it is important to take repeated samplings from the same field to exactly the same depth.

3. Take at least 10 soil cores or borings for each composite sample and, preferably, at least two composite samples for every field. For non-responsive fields greater than 5 acres in size, obtain, at a minimum, the number of samples specified in Table 1. For responsive fields, as well as all fields that have not been sampled in the past 4 years, take one composite sample for every 5 acres.
4. Avoid sampling the following:
  - Dead furrows or back furrows.
  - Lime, sludge, or manure piles.
  - Animal droppings.
  - Near fences or roads.
  - Rows where fertilizer has been banded.
  - Eroded knolls.
  - Low spots.
  - Where stalks or large bales were stacked.
  - Headlands.
  - Areas that vary widely from the rest of the field in color, fertility, slope, texture (sandy, clayey, etc.), drainage, or productivity. If the distinctive area is large enough to receive lime or fertilizer treatments different from the rest of the field, sample it separately.
5. Thoroughly mix the sample, then place about 2 cups of soil in a sample bag.
6. Identify the bag with your name, field identification, and sample number.
7. Record the field and sample location on an aerial photo or sketch of the farm and retain for your reference. Record the GPS coordinates, if applicable.
8. Fill out the soil information sheet. A completely and carefully filled out information sheet will provide the most accurate nutrient recommendations.

Always include a soil test information sheet when submitting soil samples to a laboratory for testing. The UW Soil and Plant Analysis Lab soil test information sheet can be found online at: [http://uwlab.soils.wisc.edu/madison/files/rfs\\_front.pdf](http://uwlab.soils.wisc.edu/madison/files/rfs_front.pdf).

Provide the soil name and field history whenever possible for more accurate recommendations. Information about legume crops previously grown on the soil and manure application history is essential for

proper nutrient crediting from these sources. Include soil names from county soil survey reports or individual farm conservation plans. For assistance obtaining this information, contact your county Extension agent, Natural Resource Conservation Service (NRCS) district conservationist, or the Land Conservation Committee (LCC).

### How often to sample

Most fields should be retested at least every 4 years to monitor soil fertility levels so that nutrient deficiencies are prevented and excess nutrient accumulation is avoided. Crop nutrient removals over a 4-year period in most cropping systems will not change soil test levels enough to affect recommended nutrient application rates. Exceptions include the sands and loamy sands, which should be tested every 2 years. Also, depending on the initial soil test phosphorus and potassium levels, cropping systems such as high-yielding corn silage or alfalfa may require more frequent testing to adequately monitor changes in soil test levels.

### What to do with soil samples

The soil samples and a completed soil information sheet can be taken to your county Extension office for forwarding to certified soil testing laboratory. Alternatively, samples can be sent directly to the soil testing laboratory or delivered in person.

To receive nutrient application rate guidelines consistent with those found in this publication, submit your soil samples to one of the Wisconsin certified laboratories. The College of Agricultural and Life Sciences, University of Wisconsin-Madison and the University of Wisconsin-Extension, through the Department of Soil Science operates soil testing laboratories at Madison and Marshfield. Several private laboratories are also certified, and are listed at <http://uwlab.soils.wisc.edu/wdatcp.htm>. To become certified, laboratories must use the soil testing methods and nutrient application rate guidelines specified by the Wisconsin Department of Agriculture, Trade and Consumer Protection (WDATCP). Certified laboratories must also meet quality control standards through periodic analysis of quality control soil samples.

To have your soil tested by the university, send your samples to either of the laboratories listed below:

Soil and Plant Analysis Laboratory  
8452 Mineral Point Road  
Verona, WI 53593-8696  
(608) 262-4364

Soil and Forage Analysis Laboratory  
8396 Yellowstone Drive  
Marshfield, WI 54449-8401  
(715) 387-2523

## Tillage system considerations when sampling

**Moldboard plowing.** Sample to the depth of tillage.

**Chisel plowing and offset disking.** Take soil samples to 3/4 of the tillage depth. When possible, take soil samples before spring or fall tillage. Sampling before tillage lets you determine the sampling depth more accurately and you can avoid fertilizer bands applied for the previous crop.

**Till-plant and ridge tillage.** Sample ridges to the 6-inch depth and furrows (between rows) to a depth of 4 inches. Combine equal numbers of soil cores from ridges and furrows to make up the composite sample.

**No-till.** Fields that have not been tilled for 5 years or more may develop an acid layer on the surface from the use of nitrogen fertilizer. This acid layer could reduce the effectiveness of triazine herbicides. Unincorporated phosphorus (P) and potassium (K) are also likely to build up in the surface soil. If an acid layer is suspected, take a separate sample to a depth of only 2 inches. When sending the soil to the lab, indicate that the sampling depth was only 2 inches. This sample will be tested for pH only, unless P and K are specifically requested. For fertilizer recommendations, take a separate sample to a depth of 6–7 inches. Fertilizer recommendations require this sampling depth because fertilizer calibration studies are based on plow-depth sampling. Sample between rows to avoid fertilizer bands.



Copyright © 2007 by the Board of Regents of the University of Wisconsin System doing business as the division of Cooperative Extension of the University of Wisconsin-Extension. Send inquiries about copyright permission to: Manager, Cooperative Extension Publishing, 432 North Lake Street, Room 103, Madison, WI 53706.

**Authors:** John B. Peters is director of the University of Wisconsin Soil Testing Labs in Madison and Marshfield, Wisconsin; Carrie A.M. Laboski is assistant professor and Larry G. Bundy is professor of soil science, College of Agricultural and Life Sciences, University of Wisconsin-Madison and University of Wisconsin-Extension, Cooperative Extension. Produced by Cooperative Extension Publishing.

**University of Wisconsin-Extension,** Cooperative Extension, in cooperation with the U.S. Department of Agriculture and Wisconsin counties, publishes this information to further the purpose of the May 8 and June 30, 1914 Acts of Congress; and provides equal opportunities and affirmative action in employment and programming. If you need this material in an alternative format, contact the Office of Equal Opportunity and Diversity Programs or call Cooperative Extension Publishing at 608-262-2655.

**This publication is available** from your Wisconsin county Extension office or from Cooperative Extension Publishing. To order, call toll free 877-WIS-PUBS (947-7827) or visit our web site at [learningstore.uwex.edu](http://learningstore.uwex.edu).

# Optimum soil test levels for Wisconsin

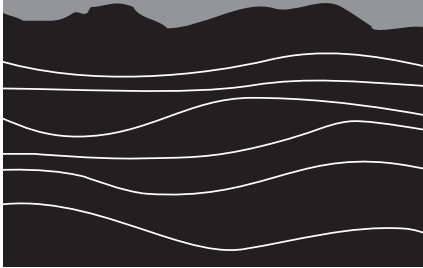

*K.A. Kelling  
L.G. Bundy  
S.M. Combs  
J.B. Peters*

**S**oil test results for phosphorus, potassium, and other mineral elements are interpreted on Wisconsin soil test reports in terms ranging from very low to excessively high. This publication explains the meaning of the ratings and how they are derived for various crops and soils. Farmers and others can use this publication along with their soil test results to evaluate the overall fertility status of their farms, estimate the likelihood of profitable fertilizer responses from the fields, and decide where to invest in lime and fertilizer for the greatest economic return and crop quality.

## Why test soils?

The goal of the fertilizer recommendations generated by the Wisconsin soil test program is to suggest appropriate nutrient levels for specific crops. When nutrient levels are deficient or excessive, the crop suffers.

Nutrient shortages markedly lower crop yield and quality. For example, potassium deficiencies have been linked to poor winter survival of alfalfa, lowered disease resistance, and increased lodging in corn and other grains. Insufficient amounts of nitrogen or sulfur can reduce protein levels in forages. Low calcium levels in fruits and vegetables can increase their susceptibility to several diseases.

Excesses of some elements can reduce yields by causing imbalances. Excessive amounts of boron, manganese, copper, and zinc can lead to toxicities. Also, once soil tests reach the high level, adding more nutrients is of little economic benefit. Excess nutrients build up when more fertilizer or manure is added than is removed by the harvested portions of the crop. It is important to know when to cut back on certain nutrients as well as when to add more.

Maintaining nutrients at optimum levels avoids economically damaging nutrient stress throughout the growing season while avoiding excesses that can cause agronomic or environmental problems. The best combination of economic return and maintenance of environmental quality is provided by considering nutrients from all sources. This means storing somewhat lower quantities of nutrients in the soil and meeting nutrient needs from both fertilizer applications and soil reserves.

## Understanding soil test interpretations

Soil test interpretations estimate the likelihood of a profitable yield increase when a given nutrient is added. The interpretation categories are described in table 1. The tests have been calibrated so that the addition of recommended amounts of nutrients are strongly suggested when the tests are at or below the optimum level. At these levels, the likelihood of obtaining a profitable economic response to applied nutrients is very good (greater than 30%).

The optimum soil test level for a given nutrient depends on a number of factors, including crop to be grown, soil type, and contributions from the subsoil.

Interpretive levels for soil pH are given graphically on the soil test report in relation to the target pH for the most acid-sensitive crop in the indicated rotation. Table 2 lists the optimum pH levels for crops grown in Wisconsin.

Most routine soil testing programs give no interpretations for nitrogen or organic matter. Under normal or higher rainfall and optimum fertilization programs, nitrogen usually does



not accumulate in soil. Because nitrogen may leach over winter, attempting to build up nitrogen in the soil is neither practical nor environmentally wise. Recommended application rates given in the routine soil test report are estimates of crop nitrogen needs for the indicated soil and assume good soil management practices are used. The recommended rates of nitrogen were determined through experiments that measured plant response on various soils. These studies showed that for some crops, including corn, the optimum rate of nitrogen on a given soil was similar in both high- and low-yielding years. For this reason, recommended nitrogen rates for corn are not based on expected yield but are soil specific. Use of special tests (e.g., spring preplant profile nitrate test and presidedress nitrogen test) can more precisely determine the specific nitrogen need.

Soil organic matter levels are controlled by factors such as soil aeration, drainage and tillage systems and cannot be increased easily without large additions of manure or other organic material or by switching to reduced tillage.

## Crop demand levels

Crops differ in their need for nutrients. The optimum potassium level for alfalfa is higher than that needed for red clover. To account for different phosphorus and potassium needs, crops have been placed in one of six demand levels: (1) corn; (2) soybeans and low-demand field crops; (3) alfalfa, irrigated field crops, and low-demand vegetable crops; (4) red clover and other medium-demand field crops; (5) high-demand vegetable crops; and (6) potatoes.

The demand level assignments for the various crops are given in table 2. These demand levels were established so that if the soil test is in the optimum range, then crop yield and profit are optimized by adding the quantity

of nutrients approximately equivalent to the amount present in the harvested part of the crop.

## Subsoil contributions

Nutrients present in the subsoil can contribute significantly to the nutrition of crops. Roots that reach down into the subsoil can use the nutrients stored there, so the level of phosphorus and potassium present in the plow layer becomes slightly less important. For example, recent research at Arlington showed that alfalfa obtained about 100 lb of potash ( $K_2O$  equivalent) per year from the subsoil.

Some subsoils are higher in phosphorus and potassium than others. To reflect this difference, the soil test report uses the subsoil fertility groups illustrated in figure 1 to distinguish different soils. These groups are based on soil samples collected at a depth of 8–30 inches from every county in a 1960 statewide survey.

When sending in soil samples for testing and fertilizer recommendations, include the soil name on the information sheet. The soil name is used to assign the correct subsoil group and to interpret soil test phosphorus and potassium data (tables 3 and 4). If the name is not given, the computer “guesses” the soil group based on soil pH, soil texture, organic matter, and county of origin. This procedure obviously does not permit as precise a fertilizer recommendation as when soil name is given. For soil name information contact your county Extension office or Natural Resource Conservation Service (NRCS). A list of the subsoil fertility groups for each of the 699 soil types currently recognized in Wisconsin may be found in Extension publication *Soil Test Recommendations for Field, Vegetable, and Fruit Crops* (A2809).

Subsoil fertility groups are also used to determine nutrient buffering capacities or how much phosphate or potash is required to raise soil test P or K to the optimum level. As shown in figure 1, soil in subsoil group D requires 18 pounds of  $P_2O_5$  per acre to change soil test P by 1 part per million (ppm). A soil in subsoil group E, on the other hand, requires only 12 pounds of  $P_2O_5$  per acre to raise soil test P by 1 ppm.

## Secondary nutrients and micronutrients

Soil tests are available upon request for secondary nutrients calcium, magnesium, and sulfur as well as trace nutrients zinc, boron, and manganese. The interpretations for these tests are given in table 5.

The sulfur availability index in table 5 is calculated by summing sulfur contributions from estimates of sulfur released from organic matter, precipitation, subsoil, and manure as well as sulfate sulfur ( $SO_4-S$ ) determined by the soil test. The procedures for estimating the amounts of sulfur contributed from these sources are described in Extension publication *Soil Test Recommendations for Field, Vegetable, and Fruit Crops* (A2809).

Available manganese is influenced both by soil pH and organic matter. When organic matter exceeds 6%, manganese availability is predicted from soil pH rather than the manganese test itself. This interpretation is shown in table 5.

Presently, there are no soil tests for copper, iron, molybdenum, and chlorine calibrated for Wisconsin soil conditions. The likelihood of deficiencies of these micronutrients is too rare to justify developing soil tests for them. If you suspect deficiencies of these nutrients, plant analysis should be used to confirm the need for making an application.



Figure 1. General subsoil fertility groups, based on available phosphorus and potassium in subsoils

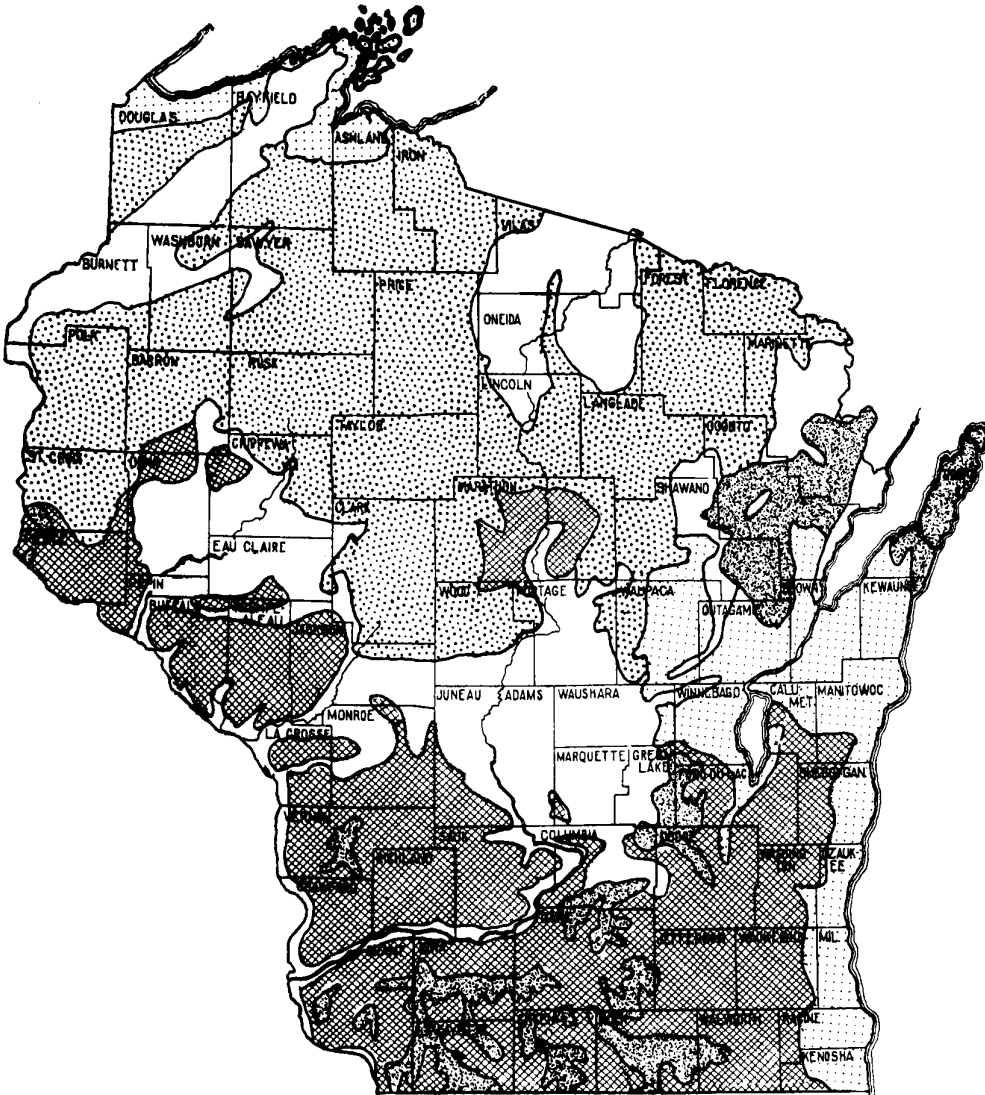

Subsoil group	Legend	Nutrient supplying power <sup>a</sup>	Nutrient buffering capacity <sup>b</sup>	
			P <sub>2</sub> O <sub>5</sub>	K <sub>2</sub> O
A		P high, K medium	18	7
B		P medium, K medium	18	7
C		P low, K high	18	7
D		P medium, K low	18	7
E		P variable, K low	12	6
O	*	P variable, K low	18	5
X	*	P low	18	—

\*Scattered throughout the state.

<sup>a</sup>All data refer to subsoils (8" to 30") only. Low, medium and high ratings are relative and are not defined in absolute units. Adapted from M.T. Beatty and R.B. Corey, 1961.

<sup>b</sup>The soil nutrient buffering capacity is the approximate amount of fertilizer in lb/a (oxide basis) required to change the soil test level (elemental basis) by 1 ppm.



Table 1. Codes and descriptions of soil test interpretation categories

—Category—		Description	Probability of yield increase <sup>a</sup> (%)
Name	Symbol		
Very low	VL	Substantial quantities of nutrients are required to optimize crop yield. Buildup should occur over a 5- to 8-year period. Response to secondary or micronutrients is likely or possible for high or medium demanding crops, respectively.	>90
Low	L	Somewhat more nutrients than those removed by crop harvest are required. Response to secondary or micronutrients is possible for high demanding crops, but unlikely for medium or low demanding crops.	60–90
Optimum	Opt	This is economically and environmentally the most desirable soil test category. Yields are optimized at nutrient additions approximately equal to amounts removed in the harvested portion of the crop. Response to secondary or micronutrients is unlikely regardless of crop demand level.	30–60
High	H	Some nutrients are required, and returns are optimized at rates equal to about one-half of nutrient removal by the crop.	5–30
Very high	VH	Used only for potassium. Soil tests are above the optimum range and gradual draw-down is recommended. Approximately one-fourth of nutrient removal is recommended.	≈5
Excessively high	EH	No fertilizer is recommended for most soils since the soil test level will remain in the nonresponsive range for at least two to three years. On medium- and fine-textured soils, a small amount of starter fertilizer is advised for row crops.	<2

<sup>a</sup> Percentage of fields that can be expected to show a profitable yield increase when recommended nutrients are applied.

Table 2. Crop codes, optimum soil pH values, and phosphorus and potassium demand levels for each crop

Crop code and name	Lime rec. Target pH		P and K demand level	Crop code and name	Lime rec. Target pH		P and K demand level
	Mineral	Organic			Mineral	Organic	
1 Alfalfa	6.8	—	3	35 Pea, canning	6.0	5.6	3
2 Alfalfa seeding	6.8	—	3	36 Pea (chick, field, cow)	6.0	5.6	3
3 Asparagus	6.0	5.6	5	37 Pepper	6.0	5.6	5
4 Barley	6.6	5.6	4	38 Popcorn	6.0	5.6	3
5 Bean, dry (kidney, navy)	6.0	5.6	3	39 Potato	5.2/6.0	5.2/5.6	6
6 Bean, lima	6.0	5.6	3	40 Pumpkin	6.0	5.6	5
7 Beet, table	6.0	5.6	5	41 Reed canarygrass	6.0	5.6	2
8 Brassica, forage	6.0	5.6	3	42 Red clover	6.3	5.6	4
9 Broccoli	6.0	5.6	5	43 Rye	5.6	5.4	4
10 Brussels sprout	6.0	5.6	5	44 Snapbean	6.8	5.6	3
11 Buckwheat	5.6	5.4	2	45 Sod	6.0	5.6	2
12 Cabbage	6.0	5.6	5	46 Sorghum, grain	5.6	5.4	2
13 Canola	5.8	5.6	1	47 Sorghum-sudan forage	5.6	5.4	2
14 Carrot	5.8	5.6	5	48 Soybean	6.3	5.6	2
15 Cauliflower	6.0	5.6	5	49 Spinach	6.0	5.6	5
16 Celery	6.0	5.6	5	50 Squash	6.0	5.6	5
17 Corn, grain	6.0	5.6	1	51 Sunflower	6.0	5.6	1
18 Corn, silage	6.0	5.6	1	52 Tobacco	5.8	5.6	5
19 Corn, sweet	6.0	5.6	3	53 Tomato	6.0	5.6	5
20 Cucumber	5.8	5.6	5	54 Trefoil, birdsfoot	6.0	5.6	4
21 Flax	6.0	5.6	2	55 Triticale	6.0	5.6	4
22 Ginseng	6.3	5.6	5	56 Truck crops	6.0	5.6	5
23 Lettuce	5.8	5.6	5	57 Vetch (crown, hairy)	6.0	5.6	4
24 Lupine	6.3	5.6	4	58 Wheat	6.0	5.6	3
25 Melon	5.8	5.6	5	59 Miscellaneous	—	—	—
26 Millet	5.6	5.4	2	60 Apple <sup>c</sup>	6.0	—	3
27 Mint, oil	6.0	5.6	5	61 Blueberry	4.5	4.5	3
28 Oat	5.8	5.6	4	62 Cherry <sup>c</sup>	6.0	—	3
29 Oatlage <sup>a</sup>	6.8	—	4	63 Cranberry	4.5	4.5	3
30 Oat-pea forage <sup>a</sup>	6.8	—	4	64 Raspberry	6.0	5.6	3
31 Onion	5.6	5.4	5	65 Strawberry	6.0	5.6	3
32 Pasture, unimproved	6.0	5.6	2	66 CRP, alfalfa	6.6	—	3
33 Pasture, managed <sup>b</sup>	6.0	5.6	1	67 CRP, red clover	6.3	5.6	4
34 Pasture, legume-grass	6.0	—	4	68 CRP, grass	5.6	5.4	2

<sup>a</sup>Assumes alfalfa underseeding.

<sup>b</sup>Includes bromegrass, fescue, orchardgrass, ryegrass, and timothy.

<sup>c</sup>Lime recommendations for apples and cherries apply only to preplant tests. Adjustment of pH is impractical once an orchard is established.

Table 3. Soil test interpretation ranges for phosphorus

Subsoil fert. group	Soil test category				
	Very low (VL)	Low (L)	Optimum (Opt)	High (H)	Excessively high (EH)
soil test P, ppm <sup>a</sup>					
Demand level 1 (corn)					
A	<5	5–10	11–15	16–25	>25
B	<10	10–15	16–20	21–30	>30
C	<10	10–15	16–20	21–30	>30
D	<8	8–12	13–18	19–28	>28
E	<12	12–22	23–32	33–42	>42
O	<12	12–22	23–32	33–42	>42
X	<5	5–8	9–15	16–25	>25
Demand level 2 (soybeans and low-demand field crops)					
A	—	<6	6–10	11–20	>20
B	—	<6	6–10	11–20	>20
C	—	<8	8–13	14–23	>23
D	—	<6	6–10	11–20	>20
E	—	<10	10–15	16–25	>25
O	—	<10	10–15	16–25	>25
X	—	<6	6–10	11–17	>17
Demand level 3 (alfalfa, irrigated field crops, and low-demand vegetable crops)					
A	<10	10–15	16–23	24–32	>32
B	<10	10–17	18–23	24–30	>30
C	<12	12–17	18–25	26–35	>35
D	<10	10–15	16–23	24–30	>30
E	<18	18–25	26–37	38–55	>55
O	<18	18–25	26–37	38–55	>55
X	<5	5–10	11–15	16–23	>23
Demand level 4 (red clover and medium-demand field crops)					
A	<10	10–15	16–20	21–25	>25
B	<10	10–15	16–20	21–25	>25
C	<12	12–17	18–23	24–30	>30
D	<8	8–12	13–18	19–23	>23
E	<15	15–22	23–30	31–38	>38
O	<15	15–22	23–30	31–38	>38
X	<5	5–10	11–15	16–20	>20
Demand level 5 (high-demand vegetable crops)					
A	<15	15–30	31–45	46–75	>75
B	<15	15–30	31–45	46–75	>75
C	<15	15–30	31–45	46–75	>75
D	<15	15–30	31–45	46–75	>75
E	<18	18–35	36–50	51–80	>80
O	<18	18–35	36–50	51–80	>80
X	<10	10–25	26–40	41–60	>60
Demand level 6 (potato)					
A	<100	100–160	161–200	>200	—
B	<100	100–160	161–200	>200	—
C	<100	100–160	161–200	>200	—
D	<100	100–160	161–200	>200	—
E	<60	60–90	91–125	126–160	>160
O	<60	60–90	91–125	126–160	>160
X	<36	36–60	61–75	76–120	>120

<sup>a</sup>ppm (wt/vol; g/m<sup>3</sup>)

Table 4. Soil test interpretation ranges for potassium

Subsoil fert. group	Soil test category					
	Very low (VL)	Low (L)	Optimum (Opt)	High (H)	Very high (H)	Excessively high (EH)
soil test K, ppm <sup>a</sup>						
Demand level 1 (corn)						
A	<60	60–80	81–100	101–140	—	>140
B	<70	70–90	91–110	111–150	—	>150
C	<60	60–70	71–100	101–140	—	>140
D	<70	70–100	101–130	131–160	—	>160
E	<45	45–65	66–90	91–130	—	>130
O	<45	45–65	66–90	91–130	—	>130
Demand level 2 (soybeans and low-demand field crops)						
A	<50	50–80	81–100	101–120	121–140	>140
B	<50	50–80	81–100	101–120	121–140	>140
C	<40	40–70	71–90	91–110	111–130	>130
D	<70	70–100	101–120	121–140	141–160	>160
E	—	<60	60–80	81–100	101–120	>120
O	—	<60	60–80	81–100	101–120	>120
Demand level 3 (alfalfa, irrigated field crops and low-demand vegetable crops)						
A	<70	70–90	91–120	121–150	151–170	>170
B	<70	70–90	91–120	121–150	151–170	>170
C	<55	55–70	71–100	101–130	131–150	>150
D	<90	90–110	111–140	141–170	171–200	>200
E	<50	50–80	81–120	121–160	161–180	>180
O	<50	50–80	81–120	121–160	161–180	>180
Demand level 4 (red clover and medium-demand field crops)						
A	<55	55–70	71–100	101–120	121–150	>150
B	<55	55–70	71–100	101–120	121–150	>150
C	<50	50–65	66–90	91–110	111–130	>130
D	<60	60–80	81–120	121–140	141–160	>160
E	<45	45–60	61–90	91–110	111–130	>130
O	<45	45–60	61–90	91–110	111–130	>130
Demand level 5 (high-demand vegetable crops)						
A	<60	60–120	121–180	181–200	201–220	>220
B	<60	60–120	121–180	181–200	201–220	>220
C	<50	50–110	111–160	161–180	181–200	>200
D	<80	80–140	141–200	201–220	221–240	>240
E	<50	50–100	101–150	151–165	166–180	>180
O	<50	50–100	101–150	151–165	166–180	>180
Demand level 6 (potato)						
A	<80	80–120	121–160	161–180	181–210	>210
B	<80	80–120	121–160	161–180	181–210	>210
C	<70	70–100	101–150	151–170	171–190	>190
D	<80	80–120	121–170	171–190	191–220	>220
E	<70	70–100	101–130	131–160	161–190	>190
O	<70	70–100	101–130	131–160	161–190	>190

<sup>a</sup>ppm (wt/vol; gm/m<sup>3</sup>)





Table 5. Interpretation of soil test values for secondary nutrients and micronutrients

Element	Soil texture code <sup>a</sup>	Soil test category				
		Very low (VL)	Low (L)	Optimum (Opt)	High (H)	Excessively high (EH)
		soil test, ppm				
Calcium	1	0–200	201–400	401–600	>600	—
	2,3,4	0–300	301–600	601–1000	>1000	—
Magnesium	1	0–25	26–50	51–250	>250	—
	2,3,4	0–50	51–100	101–500	>500	—
Boron	1	0–0.2	0.3–0.4	0.5–1.0	1.1–2.5	>2.5
	2,4	0–0.3	0.4–0.8	0.9–1.5	1.6–3.0	>3.0
	3	0–0.5	0.6–1.0	1.1–2.0	2.1–4.0	>4.0
Zinc	1,2,3,4	0–1.5	1.6–3.0	3.1–20	21–40	>40
Manganese	1,2,3,4	—	0–10	Soil pH		—
O.M. less than 6.1%	1,2,3,4	—	>6.9	6.0–6.9	<6.0	—
O.M. more than 6.0%	1,2,3,4	—				
		SAI <sup>b</sup>				
Sulfur	1,2,3,4	—	<30	30–40	>40	—

<sup>a</sup>Soil texture codes: 1 = sandy soils; 2 = loams, silts, and clays; 3 = organic soils; 4 = red soils.

<sup>b</sup>Sulfur availability index (SAI) includes estimates of sulfur released from organic matter, sulfur in precipitation, subsoil sulfur and sulfur in manure if applied, as well as sulfate sulfur (SO<sub>4</sub>-S) determined by soil test.



Copyright © 1999 by the Board of Regents of the University of Wisconsin System doing business as the division of Cooperative Extension of the University of Wisconsin-Extension. Send inquiries about copyright permission to: Director, Cooperative Extension Publishing, 201 Hiram Smith Hall, 1545 Observatory Dr., Madison, WI 53706.

Authors: K.A. Kelling and L.G. Bundy are professors of soil science, College of Agricultural and Life Sciences, University of Wisconsin-Madison and University of Wisconsin-Extension, Cooperative Extension. S.M. Combs is director of the University of Wisconsin Soil and Plant Analysis Lab-Madison, and J.B. Peters is director of the University of Wisconsin Soil and Forage Lab-Marshfield. Produced by Cooperative Extension Publishing.

University of Wisconsin-Extension, Cooperative Extension, in cooperation with the U.S. Department of Agriculture and Wisconsin counties, publishes this information to further the purpose of the May 8 and June 30, 1914 Acts of Congress; and provides equal opportunities and affirmative action in employment and programming. If you need this material in an alternative format, contact the Office of Equal Opportunity and Diversity Programs or call Cooperative Extension Publishing at 608-262-2655.

This publication is available from your Wisconsin county Extension office or from Cooperative Extension Publishing, Rm. 170, 630 W. Mifflin Street, Madison, WI 53703, 608-262-3346. Outside Madison, call our toll-free number: 877-WIS-PUBS (947-7827). Before publicizing, please check on this publication's availability. To see more Extension publications, visit our web site at [www.uwex.edu/ces/pubs/](http://www.uwex.edu/ces/pubs/).

## Soil and Applied Nitrogen

L.G. Bundy

The atmosphere contains about 78% nitrogen gas ( $N_2$ ). This is the equivalent of more than 30,000 tons/a. However, most plants cannot use nitrogen as it exists in the atmosphere. It must first be converted through biological or chemical fixation.

**1. Biological fixation**—Rhizobia and other bacteria that live in the roots of legumes take nitrogen from the air and fix it in a form that plants can use. This mutually beneficial relationship between microorganisms and plants is called symbiosis.

*Figure 1. The nitrogen cycle. Biological transformations of nitrogen in soil are numbered and explained under “Nitrogen Reactions in Soils.”*

**2. Chemical fixation**—In the manufacture of chemical nitrogen fertilizer, atmospheric nitrogen ( $N_2$ ) is combined with hydrogen ( $H_2$ ) to form ammonia ( $NH_3$ ). Ammonia can be sold for direct application, or it can be used to manufacture other forms of nitrogen fertilizer such as ammonium nitrate ( $NH_4NO_3$ ) or urea ( $CO(NH_2)_2$ ).

Nitrogen exists in many different forms. Several physical, chemical, and biological processes affect its availability to plants. Collectively, these transformations make up the nitrogen cycle, illustrated in Figure 1.

### NITROGEN REACTIONS IN SOILS

#### Biological Transformations

**Symbiotic fixation.** Legumes inoculated with the proper strain of nodule-forming bacteria use atmospheric nitrogen (Reaction 1 in Figure 1). Most legumes fix all the nitrogen they need and do not need nitrogen fertilizer. In addition, many legumes supply substantial amounts of nitrogen to the succeeding crop.

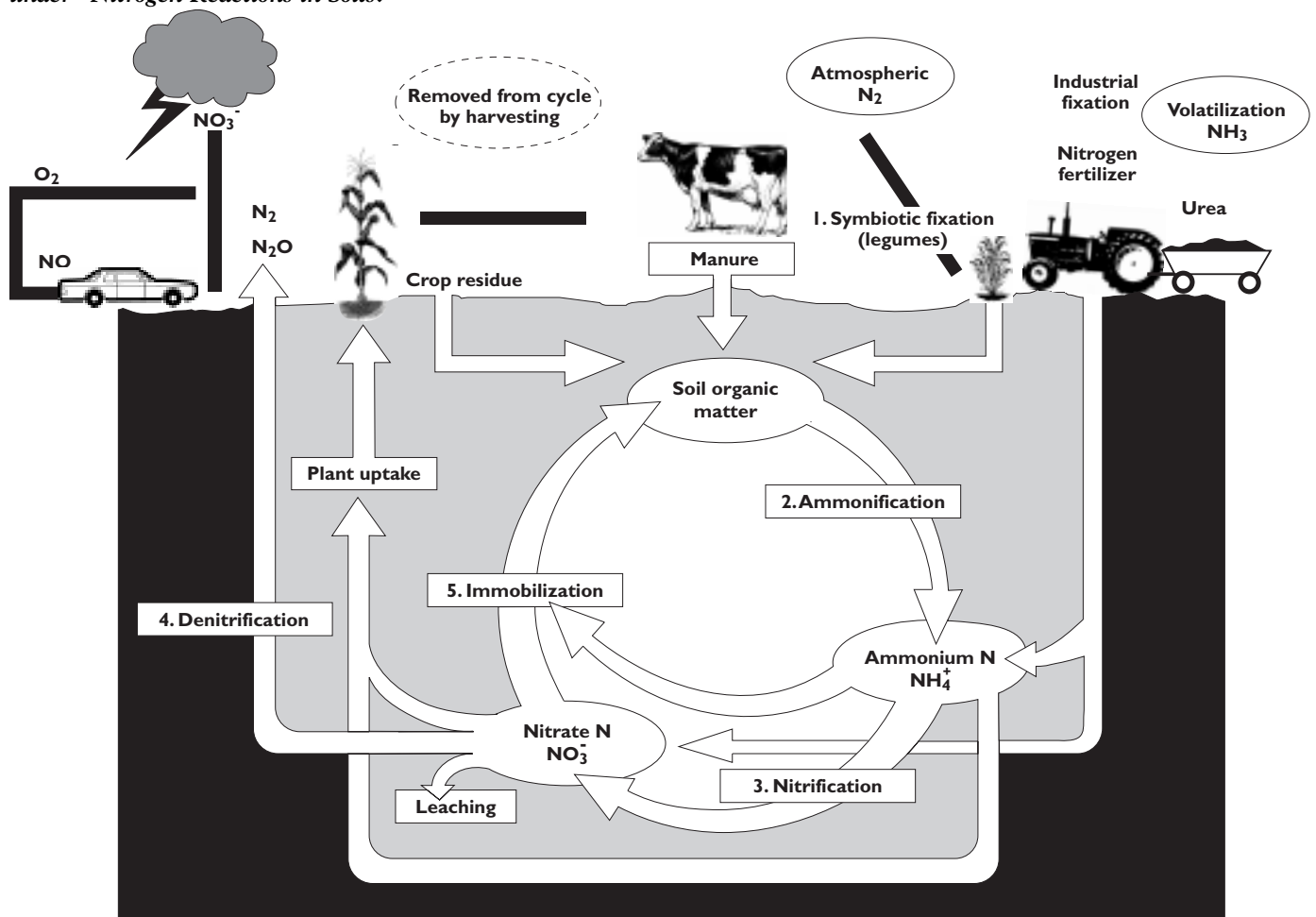

**Ammonification.** This is the conversion of organic nitrogen into ammonium by soil microbes (Reaction 2 in Figure 1). Plants can use ammonium nitrogen, and it is not lost by leaching. Negatively charged particles of clay minerals and soil organic matter hold the positively charged ammonium ion ( $\text{NH}_4^+$ ). This greatly restricts its movement by percolating water.

**Nitrification.** This is the conversion of ammonium nitrogen to nitrate nitrogen by soil bacteria (Reaction 3 in Figure 1). Nitrate ions ( $\text{NO}_3^-$ ) are readily available to plants. However, their negative charge causes them to remain in solution in the soil, and they can be leached below the root zone by percolating water.

Nitrification occurs rapidly in warm, well-aerated, and properly limed soils (pH of 6.5–7.0). When conditions are favorable, the ammonium form of nitrogen in fertilizers is changed to the nitrate form within 1–2 weeks after application.

**Denitrification.** In poorly aerated, water-logged soils, soil bacteria change available nitrate nitrogen into unavailable atmospheric nitrogen (Reaction 4 in Figure 1). Decomposable organic matter must be present as a source of energy for denitrification to occur. This energy requirement often limits denitrification deep in the subsoil or in groundwater.

Denitrification takes place very rapidly. If water stands on the soil for only 2–3 days during the growing season, most of the nitrate nitrogen will be lost through denitrification. Yellowing of corn and other crops grown on poorly aerated soils is often due to a nitrogen deficiency.

**Immobilization.** Carbon-rich crop residues, such as straw or corn stalks, can cause temporary nitrogen deficiency because the bacteria that decompose the residues temporarily immobilize or “tie up” available ammonium or nitrate nitrogen (Reaction 5 in Figure 1). Most of the

nitrogen immobilized as microbial protein becomes part of the soil organic matter and is slowly released in a plant-available form as the organic matter decomposes.

The addition of nitrogen fertilizer sometimes is recommended to hasten decomposition of crop residues. However, most well-managed soils contain enough nitrogen to break down the crop residue. The size of the residue particles usually is more important than the amount of nitrogen in determining how fast residues will decompose in soil: small particles decompose much more rapidly than large particles. For rapid decomposition, chop or shred corn stalks and other crop residues.

## NITROGEN LOSSES

### Leaching

Leaching of nitrate nitrogen can be a serious problem, especially on sandy soils. Because sandy soils retain only about 1 inch of water per foot of soil, relatively small amounts of rain or irrigation water readily move nitrate below the root zone. Well-drained silt and clay soils retain about 3 inches of water per foot of soil, so rapid leaching occurs in these soils only when rainfall is abnormally high.

Ammonium nitrogen is held on soil particles and is essentially non-leachable. Nitrate nitrogen is not held by soil particles and can be leached below the root zone. This does not mean that ammonium nitrogen is more effective than nitrate nitrogen. Ammonium nitrogen quickly changes to nitrate nitrogen under optimum soil conditions. As a result, nitrogen loss through leaching can occur even where nitrogen is initially applied as ammonium.

### Volatilization

When manure, urea fertilizer, or solutions containing urea are surface applied and not worked into the soil, some nitrogen can be lost as ammonia

gas. Direct loss of ammonia from anhydrous ammonia occurs if the material is not properly injected into the soil. Proper injection of solutions containing ammonia and immediate incorporation of manure and urea-containing fertilizer eliminate volatilization losses. A light rainfall (0.1–0.2 inches) within 1–2 days after surface application of urea-containing fertilizers will greatly reduce or eliminate ammonia volatilization. Little ammonia loss will occur when ammonium nitrate, ammonium sulfate, or ammonium phosphate are surface applied on acid or neutral soils. Incorporate ammonium sulfate or ammonium phosphate on high-pH soils. (See also “Urease Inhibitors” on page 4.)

### Denitrification

As previously noted, most of the available nitrate nitrogen in soil converts to unavailable atmospheric nitrogen when soils are poorly aerated. It is important, therefore, to provide adequate surface or subsoil drainage on soils that tend to be poorly drained.

## SOURCES OF NITROGEN

### Organic Matter

Soils often contain 2,000–6,000 lb/a of organic nitrogen, but almost all of this nitrogen is combined in stable organic matter (humus) that decomposes very slowly. Mineral soils in Wisconsin supply only about 25–75 lb/a of available nitrogen annually. Nonlegume crops usually require additional nitrogen from fertilizer, previous legumes, or manure to achieve optimum yields.

### Nitrogen Fertilizers

Many different chemical and physical forms of nitrogen fertilizer are available. If properly applied, the various forms are equally effective, although one form may have an advantage over another under certain conditions. Table 1 lists the general characteristics of the important fertilizer sources of nitrogen.

Table 1. Nitrogen fertilizers.

FERTILIZER	CHEMICAL FORMULATION	ANALYSIS (N-P <sub>2</sub> O <sub>5</sub> -K <sub>2</sub> O)	PHYSICAL FORM	METHOD OF APPLICATION
Ammonium nitrate	NH <sub>4</sub> NO <sub>3</sub>	33-0-0	dry prills	Broadcast or sidedress. Can be left on the soil surface.
Ammonium sulfate	(NH <sub>4</sub> ) <sub>2</sub> SO <sub>4</sub>	21-0-0	dry granules	Broadcast or sidedress. Can be left on the soil surface. <sup>a</sup>
Anhydrous ammonia	NH <sub>3</sub>	82-0-0	high-pressure liquid	Must be injected 6–8 inches deep on friable <sup>b</sup> moist soil. Excessive loss will occur from wet soils.
Aqua ammonia	NH <sub>4</sub> OH	20-0-0 to 24-0-0	low-pressure liquid	Must be injected 2–3 inches deep on friable <sup>b</sup> moist soils. Excessive loss will occur from wet soils.
Calcium nitrate	Ca(NO <sub>3</sub> ) <sub>2</sub>	15.5-0-0	dry granules	Broadcast or apply in the row. Can be left on the soil surface.
Diammonium phosphate	(NH <sub>4</sub> ) <sub>2</sub> HPO <sub>4</sub>	18-46-0	dry granules	Broadcast or apply in the row. Can be left on the soil surface. <sup>a</sup>
Low-pressure nitrogen solutions	NH <sub>4</sub> NO <sub>3</sub> + NH <sub>3</sub> + H <sub>2</sub> O	37-0-0 41-0-0	low-pressure liquid	Must be injected 2–3 inches deep on friable <sup>b</sup> moist soils. Excessive loss will occur from wet soils.
Potassium nitrate	KNO <sub>3</sub>	13-0-44	dry granules	Broadcast or apply in the row. Can be left on the soil surface.
Pressureless nitrogen solutions	NH <sub>4</sub> NO <sub>3</sub> + urea + H <sub>2</sub> O	28-0-0 32-0-0	pressureless liquid	Spray on surface or sidedress. Incorporate surface applications to prevent volatilization loss of NH <sub>3</sub> from urea.
Urea	CO(NH <sub>2</sub> ) <sub>2</sub>	45-0-0	dry prills or granules	Broadcast or sidedress. Incorporate surface applications to prevent volatilization loss of NH <sub>3</sub> from urea.

<sup>a</sup>Incorporate on high pH soils.

<sup>b</sup>Friable soils are those which are easily crumbled or pulverized.

**Timing of application.** The timing of nitrogen fertilizer applications can markedly affect their efficiency and the potential for nitrogen losses. Supplying the needed nitrogen just prior to the crop's greatest demand maximizes the efficiency of nitrogen applications. For spring-planted crops, sidedress and spring preplant applications provide greater nitrogen efficiency than fall applications, which are usually 10–15% less effective in increasing crop yields.

Fall applications are most effective on medium-textured, well-drained soils, where nitrogen loss through leaching and denitrification is usually

low. They are *not* effective on sandy soils, shallow soils over fractured bedrock, or fine-textured, poorly drained soils. Price and convenience advantages frequently associated with fall-applied nitrogen must be weighed against the possibility of lower effectiveness and nitrate nitrogen losses.

Sidedress nitrogen applications during the growing season are effective on all soils. Proper timing of these applications is essential to provide available nitrogen during the period in which the crop uses nitrogen rapidly. Benefits from using sidedress instead of preplant applications are greatest on

sandy soils or on fine-textured, poorly drained soils.

Spring preplant applications are usually as effective as sidedress treatments on medium-textured, well-drained soils, because the risk of leaching or denitrification on these soils is low.

**Nitrification inhibitors.** Using a nitrification inhibitor such as nitrapyrin (N-Serve) or dicyandiamide (DCD) with ammonium forms of nitrogen fertilizer can reduce nitrogen losses on soils where leaching or denitrification is likely. Nitrification inhibitors slow the conversion of ammonium to nitrate by soil organisms (Reaction 3 in

Figure 1). Because leaching and denitrification occur through the nitrate form of nitrogen, maintaining fertilizer nitrogen in the ammonium form should reduce nitrogen losses through these processes.

Nitrification inhibitors are likely to increase crop yields when used with spring preplant nitrogen applications on sandy soils or fine-textured, poorly drained soils. Yield increases are also likely from inhibitor use with fall-applied nitrogen on medium-textured, well-drained soils. However, spring-applied nitrogen fertilizer is usually more effective than fall-applied nitrogen even with use of a nitrification inhibitor. Using nitrification inhibitors with spring preplant nitrogen on medium-textured, well-drained soils or with sidedress applications on any soil type is not likely to improve yields.

**Urease inhibitors.** Use of urease inhibitors such as NBPT (Agrotain) with surface-applied urea-containing fertilizers can reduce ammonia losses and improve nitrogen efficiency. However, they do not consistently increase yields. The decision to use a urease inhibitor will depend on the risk of nitrogen loss that could be controlled, the cost of using the inhibitor, and the cost and convenience of other nitrogen sources or placement methods that are not subject to ammonia loss. Alternatives include injecting or incorporating the urea-containing fertilizers or using non-urea nitrogen sources.

**Nitrogen management recommendations.** To minimize leaching or denitrification losses, follow these general recommendations.

**1. Sandy soils**—Apply nitrogen as a sidedress treatment. Fall or spring preplant treatments result in excessive

losses on sandy soils. If you must use spring preplant applications, apply ammonium forms of nitrogen treated with a nitrification inhibitor. For irrigated crops, apply part of the nitrogen through the irrigation water.

**2. Well-drained silty or clayey soils**—Spring preplant or sidedress applications can contain any form of nitrogen. If you must make fall applications, use ammonium forms of nitrogen with a nitrification inhibitor.

**3. Poorly drained soils**—Use sidedress applications or apply nitrification inhibitors with spring preplant treatments.

### Legumes

Legumes can supply substantial amounts of nitrogen to the succeeding crop. Table 2 indicates the nitrogen credit that should be given to various legume crops. For additional information, see Extension publication *Using Legumes as a Nitrogen Source* (A3517).

Table 2. Nitrogen credits for previous legume crops.<sup>a</sup>

LEGUME CROP	NITROGEN CREDIT	EXCEPTIONS
<b>Forages</b>		
<b>First-year credit</b>		
Alfalfa	190 lb/a N for a good stand <sup>b</sup> 160 lb/a N for a fair stand <sup>b</sup> 130 lb/a N for a poor stand <sup>b</sup>	Reduce credit by 50 lb/a N on sandy soils. <sup>c</sup> Reduce credit by 40 lb/a N if plant regrowth was less than 6–10 inches prior to tillage or plant death.
Birdsfoot trefoil, red clover	Use 80% of alfalfa credit.	Same as alfalfa.
<b>Second-year credit</b>		
Fair or good stand	50 lb/a N	No credit on sandy soils. <sup>c</sup>
<b>Green manure crops</b>		
Alfalfa	60–100 lb/a N	Use 40 lb/a N credit if field has less than 6 inches of growth before tillage.
Red clover	50–80 lb/a N	
Sweet clover	80–120 lb/a N	
<b>Soybean</b>	40 lb/a N	No credit on sandy soils. <sup>c</sup>
<b>Leguminous vegetable crops</b>		
Pea, lima bean, snap bean	20 lb/a N	No credit on sandy soils. <sup>c</sup>

<sup>a</sup>Legume credits to a following corn crop can be confirmed by using the presidedress nitrogen test (PSNT) when corn is 6–12 inches tall.

<sup>b</sup>A good stand of alfalfa (>70% alfalfa) has more than 4 plants/ft<sup>2</sup>; a fair stand (30–70% alfalfa) has 1.5–4 plants/ft<sup>2</sup>; and a poor stand (<30% alfalfa) has less than 1.5 plants/ft<sup>2</sup>.

<sup>c</sup>Sandy soils are sands and loamy sands.



Table 3. Nitrogen content and first-year credits for solid and liquid manure.

TYPE OF MANURE	% OF TOTAL N AVAILABLE IN FIRST YEAR	APPLICATION METHOD	NITROGEN CONTENT OF MANURE			
			SOLID (lb/ton)		LIQUID (lb/1000 gal)	
			TOTAL	N CREDIT	TOTAL	N CREDIT
Beef	25%	Surface	14	4	40	10
	30%	Incorporated <sup>a</sup>	14	4	40	12
Dairy	30%	Surface	10	3	28	8
	35%	Incorporated <sup>a</sup>	10	4	28	10
Poultry	50%	Surface	25	13	70	35
	60%	Incorporated <sup>a</sup>	25	15	70	41
Swine	40%	Surface	10	4	55	22
	50%	Incorporated <sup>a</sup>	10	5	55	28

<sup>a</sup>Injected or incorporated within 72 hours of application.

Adapted from: USDA-SCS. Wisconsin Field Office Technical Guide. Sec. IV. Spec. 590.

## Manure

Manure contains substantial amounts of nitrogen, but much of the nitrogen is in the organic form and is not all available in the first year following application. The amount of manure nitrogen available to a crop depends on the type of manure, the application rate, the method of application, and the consecutive years of application. Reduce or eliminate fertilizer nitrogen applications when you apply manure. Table 3 lists first-year nitrogen credits for solid and liquid manure. For additional information, see Extension publication *Guidelines for Applying Manure to Cropland and Pastures in Wisconsin* (A3392).

## Precipitation

In rural areas in Wisconsin, precipitation accounts for about 10 lb/a of available nitrogen (ammonium + nitrate nitrogen) annually. This is a small addition on a per-acre basis, but it is a significant contribution to the total nitrogen budget for the state.

## DIAGNOSTIC TECHNIQUES

### Deficiency Symptoms

Lack of nitrogen first appears as a light green coloring of the plant. As the deficiency becomes more severe, leaves turn yellow and may “fire.” Nitrogen deficiency first appears on the

plant’s lower leaves and gradually progresses up the plant. On corn, this yellowing starts at the midrib of the leaf with the edge of the leaf remaining green. Corn, small grains, and forage grasses all require relatively high amounts of nitrogen and show deficiency symptoms whenever nitrogen is in short supply. Yellowing of the bottom few leaves as corn plants approach physiological maturity is normal and usually does not indicate a nitrogen deficiency.

### Soil Analysis

Nearly all nitrogen in the soil is in the unavailable organic form. The amount of organic nitrogen that soil bacteria convert to an available form depends on such environmental factors as temperature, rainfall, and soil oxygen levels. Soil organic matter content provides a general indication of the soil’s nitrogen-supplying capability, and nitrogen recommendations in Wisconsin take this source of nitrogen into account.

Soil nitrate testing allows nitrogen fertilizer recommendations to be adjusted for field-specific conditions that can influence crop nitrogen needs. Two nitrate tests, a preplant soil nitrate test and a presidedress soil nitrate test, are available for improving the efficiency of nitrogen fertilizer applica-

tions. These tests offer economic and environmental benefits. Economically, tailoring nitrogen applications to crop needs saves fertilizer dollars. Environmentally, avoiding over-application of nitrogen reduces the potential for nitrate movement to groundwater.

A preplant soil profile nitrate test (PPNT) is useful for predicting site-specific nitrogen fertilizer needs, particularly for corn production. Soil samples, taken in 1-foot increments to a depth of 2 feet, are used to measure residual nitrate nitrogen in the crop root zone in early spring. The factors that influence the amount of residual nitrate nitrogen in the soil include October-to-April precipitation, soil texture, crop sequence, and repeated manure applications. The PPNT is likely to be most beneficial when corn follows corn on medium- and fine-textured soils and when October-to-April precipitation is normal or below normal. Even in years of above-normal winter precipitation, the test is likely to be beneficial in second-year corn following alfalfa, in continuous corn, and in fields with a history of manure applications. The test is not useful on sandy soils because potential nitrate nitrogen carryover is almost always low in these soils.

Table 4. Nitrogen plant analysis interpretations for common Wisconsin field crops.

CROP	PLANT PART SAMPLED	TIME OF SAMPLING	INTERPRETATION			
			DEFICIENT	LOW	SUFFICIENT	HIGH
			% N			
Alfalfa <sup>a</sup>	Top 6 inches	Early bud	<1.25	1.25–2.50	2.51–3.70	>3.70
Barley, oat, wheat	Top leaves	Boot stage	<1.50	1.50–2.00	2.01–3.00	>3.00
Corn	Ear leaf	Silking	<1.75	1.75–2.75	2.76–3.75	>3.75

<sup>a</sup> First crop.

A pre-sidedress soil nitrate test (PSNT) allows adjustments to nitrogen recommendations based on the soil's nitrate content. Soil samples, taken to a depth of 1 foot, are collected after planting is completed. This test measures the amount of nitrogen released from previous legume crops, manure applications, and soil organic matter as well as part of the nitrogen carried over from the previous growing season. The PSNT is a beneficial tool for confirming nitrogen contributions from fall, winter, and spring manure applications and from forage legume crops preceding first-year corn. This test is not recommended on sandy soils. For more information see Extension publication *Soil Nitrate Tests for Wisconsin Cropping Systems* (A3624).

### Plant Analysis

Although plant tissue analysis can indicate whether a plant is deficient in nitrogen, it is difficult to detect small differences in nitrogen availability with a tissue sample alone. Many environmental factors such as moisture stress, light intensity, and time of day can

affect the amount of nitrogen in plant tissue. In addition, the amount of total nitrogen (crude protein) in a plant decreases as the plant grows. It is important to specify the stage of growth when sampling a crop for nitrogen analysis. Table 4 gives an approximate interpretation of nitrogen plant analyses for the major agronomic crops grown in Wisconsin. For additional information about plant analysis, see Extension publication *Sampling for Plant Analysis: A Diagnostic Tool* (A2289).

### ENVIRONMENTAL EFFECTS

Excessive nitrate in drinking water can cause human and animal health problems. Nitrate and other nitrogen compounds also can hasten deterioration of lakes and streams by promoting excessive growth of weeds and algae. The following recommendations can minimize these adverse environmental effects.

- n Use recommended rates of nitrogen fertilizer; give credit to nitrogen from manures and

legumes and to residual nitrate nitrogen as measured by the Wisconsin preplant soil profile nitrate test.

- n When possible, time the application of nitrogen fertilizer with nitrogen uptake by the crop, especially on irrigated sandy soils.
- n Practice good conservation to minimize erosion losses.
- n Maintain a rotation that includes a deep-rooted crop, such as alfalfa.
- n Eliminate winter and fall applications of fertilizer.
- n Avoid winter application of manure when feasible.
- n Locate rural wells as far as possible from farm lots and other areas where manure accumulates.

For additional information on the environmental effects of nitrogen see Extension publication *Nitrate in Wisconsin Groundwater: Sources and Concerns* (G3054).



©1998 University of Wisconsin System Board of Regents and University of Wisconsin-Extension

**Author:** L.G. Bundy is professor of soil science, College of Agricultural and Life Sciences, University of Wisconsin-Madison and University of Wisconsin-Extension, Cooperative Extension. Produced by Cooperative Extension Publications, University of Wisconsin-Extension.

**University of Wisconsin-Extension,** Cooperative Extension, in cooperation with the U.S. Department of Agriculture and Wisconsin counties, publishes this information to further the purpose of the May 8 and June 30, 1914 Acts of Congress. An Equal Employment Opportunity/Affirmative Action employer, University of Wisconsin-Extension provides equal opportunities in employment and programming, including Title IX requirements. If you need this material in an alternative format, contact the Office of Equal Opportunity and Diversity Programs or call Cooperative Extension Publications at 608-262-2655.

**This publication is available** from your Wisconsin county Extension office or from Cooperative Extension Publications, Rm. 170, 630 W. Mifflin St., Madison, Wisconsin 53703. Phone 608-262-3346.



# Soil and Applied Phosphorus

*E.E. Schulte and K.A. Kelling*

**S**oils generally contain 500–1000 parts per million (ppm) of total phosphorus (inorganic and organic), but most of this is in a “fixed” form that is unavailable for plant use.

Furthermore, soluble phosphorus in fertilizer or other nutrient sources is quickly converted to less-available forms when added to the soil. Although some Wisconsin soils may require large phosphorus additions for best yields, the past use of phosphorus fertilizer and applications of manure have led to unnecessarily high phosphorus levels in many soils. Based on Wisconsin soil test recommendations for field crops, the average soil test phosphorus (44 ppm of extractable phosphorus) for 450,000 Wisconsin soil samples analyzed between 1982 and 1985 was in the excessively high range.

## PHOSPHORUS REACTIONS IN SOILS

**T**he two main categories of phosphorus (P) in soils are organic and inorganic. The organic form is found in humus and other organic materials. The inorganic portion occurs in various combinations with iron, aluminum, calcium, and other elements, most of which are not very soluble in water. Both organic and inorganic forms of phosphorus are important sources of phosphorus for plant growth, but their availabilities are controlled by soil characteristics and environmental conditions.

### Phosphorus Fixation

One of the unique characteristics of phosphorus is its immobility in soil. Practically all soluble phosphorus from fertilizer or manure is converted in the soil to water-insoluble phosphorus within a few hours after application.

Phosphorus occurs in the soil solution as the negatively charged phosphate ion  $\text{H}_2\text{PO}_4^-$  in acid soils or  $\text{HPO}_4^{=}$  in alkaline soils. These ions react readily with iron, aluminum, and manganese compounds in acid soils and with calcium compounds in neutral and alkaline soils. They become strongly attached to the surfaces of these compounds or form insoluble phosphate precipitates. These reactions remove immediately available phosphate ions from the soil solution. Phosphate ions do not leach, as do nitrate ions, even in sandy soils. Studies of highly fertilized, intensively farmed land indicate that the annual loss of phosphorus in drainage water seldom exceeds 0.1 lb/a. The plow layer of the soil usually retains almost all (98–99%) of the applied phosphorus. This means that very little phosphorus moves into or through the subsoil. Acid soils fix more phosphorus than neutral soils; liming acid soils to a pH of 6.0–6.8 increases the availability of both soil and fertilizer phosphorus.

### Phosphorus in Organic Matter

The relative amounts of organic and inorganic phosphorus vary considerably. In Wisconsin, organic phosphorus accounts for 30–50% of the total phosphorus in most mineral soils. Decomposition (mineralization) of organic matter converts organic forms of phosphorus to inorganic available forms. As with the mineralization of organic nitrogen, organic phosphorus is released more rapidly in warm, well-aerated soils. This explains why crops grown in cold, wet Wisconsin soils often respond to row-applied phosphorus even though the soil may be well supplied with phosphorus or broadcast phosphorus fertilizer has been added.

## ENVIRONMENTAL HAZARDS

**A**quatic weeds and algae respond to increasing amounts of phosphorus just as land plants do. Luxurious growth of weeds and algae often results when additional phosphorus enters a lake or stream. Of all plant nutrients, phosphorus is usually the most closely associated with accelerated production of weeds and algae. However, runoff water usually contains very low quantities of soluble phosphorus, even when phosphorus is surface-applied, because of phosphorus immobility in soil. Also, only negligible amounts of phosphorus in soil water percolate through soils. Phosphorus enters surface water mainly by erosion of phosphorus-holding soil particles and organic residues. For these reasons, excessive buildup of soil phosphorus should be avoided, especially in erodible soils. Contact your county Extension agent for further information on recommended practices to minimize phosphorus losses from agricultural land.

## FERTILIZER SOURCES OF PHOSPHORUS

**R**ock phosphate is the original source of nearly all phosphorus fertilizer sold in the United States. Mined rock phosphate is too insoluble to be a useful source of phosphorus for crops, except when very finely ground and when soil pH is below 6.0. During the manufacture of fertilizer, insoluble rock phosphate is treated with an acid to convert it to more-available superphosphate or ammonium phosphate. This process neutralizes the acid; application of phosphate fertilizer results in very little residual acidity when it is applied to the soil. The

common phosphate fertilizers, listed in Table 1, are seldom applied alone in Wisconsin. Usually they are manufactured or blended with nitrogen, potassium, or both to form a mixed fertilizer such as 6-24-24 or 9-23-30.

### Orthophosphate versus Polyphosphate

Sources of phosphorus containing the  $\text{H}_2\text{PO}_4^-$  or  $\text{HPO}_4^{2-}$  ions are called orthophosphates. Polyphosphates contain a mixture of orthophosphate and some long-chain phosphate ions such as pyrophosphate,  $(\text{HP}_2\text{O}_7)_3^-$ . Commercially produced polyphosphate contains approximately 50% orthophosphate and 50% long-chain phosphate compounds.

Claims that polyphosphates are superior to orthophosphates exaggerate their ability to partially chelate or combine with certain micronutrients and hold them in an available form. Research has not demonstrated that this difference improves yields or increases nutrient uptake in most soils. Polyphosphate ions react with soil moisture to form orthophosphates relatively rapidly (1–2 weeks). On almost all soils, orthophosphate and

polyphosphate fertilizers are equally effective.

### Effect of Water Solubility

The amount of water-soluble phosphorus in the different sources of available phosphorus varies considerably (Table 1). When phosphorus is broadcast and incorporated or when it is topdressed on forages, the amount of water solubility makes little or no difference. University of Wisconsin research shown in Table 2 illustrates that the differences in water solubility among concentrated superphosphate (85% soluble), ammoniated superphosphate (60% soluble), and monoammonium phosphate (92% soluble) did not influence yields. Increasing the amount of water-soluble phosphorus above 60% did not increase yields. All commonly used phosphorus fertilizers presently sold in Wisconsin (except rock phosphate) contain at least 85% water-soluble phosphorus.

### Liquid versus Dry Phosphate

Compared to conventional dry fertilizers, liquid fertilizers are easier to handle, mix, and apply. Despite claims to the contrary, research has shown that liquid phosphate does not improve fertilizer phosphorus availability or recovery. It is the soil interactions that control phosphorus uptake, not the physical form of the fertilizer applied.

### Rock Phosphate versus Superphosphate

Rock phosphate is sometimes recommended instead of superphosphate for building up the “reserve” level of phosphate in soil. The phosphorus in rock phosphate becomes available only when the soil is acid (below pH 5.5), and therefore its use by Wisconsin dairy farms is not recommended. The pH should be about 6.8 for high-quality alfalfa and at least 6.0–6.2 for most other agronomic crops. Research in the 1950s clearly demonstrated that rock phosphate is not an effective phosphorus source in most soils.

Table 1. Fertilizer sources of phosphorus.

NAME OF FERTILIZER	CHEMICAL FORMULA	FERTILIZER ANALYSIS	WATER SOLUBILITY
		EQUIVALENT N-P <sub>2</sub> O <sub>5</sub> -K <sub>2</sub> O	
		%	
Ammonium polyphosphate Liquid Dry	$\text{NH}_4\text{H}_2\text{PO}_4 + (\text{NH}_4)_3\text{HP}_2\text{O}_7$	10-34-0	100
		15-62-0	100
Diammonium phosphate	$(\text{NH}_4)_2\text{HPO}_4$	18-46-0	>95
Monoammonium phosphate	$\text{NH}_4\text{H}_2\text{PO}_4$	11-48-0	92
Ordinary superphosphate	$\text{Ca}(\text{H}_2\text{PO}_4)_2 + \text{CaSO}_4$	0-20-0	85
Rock phosphate	$3\text{Ca}_3(\text{PO}_4)_2 \cdot \text{CaF}_2$	0-32-0	<1
Triple superphosphate	$\text{Ca}(\text{H}_2\text{PO}_4)_2$	0-46-0	87



## METHOD OF APPLICATION

Plants need relatively large amounts of phosphorus early in the life cycle. Root development is limited in cool, wet soils, and very little phosphorus is released from soil organic matter. Some studies have found banded phosphorus to be nearly twice as efficient as broadcast phosphorus in cold soils. In well-drained, fertile soils that warm up early in the spring, however, row and broadcast applications are often equally effective. Since phosphorus moves very little from the point of application, place the row fertilizer 1–2 inches to the side and below the seed. Be careful not to apply excessive rates of starter fertilizer, particularly when using highly ammoniated fertilizers on high-pH soils. Optimum starter rates depend on soil test levels, the distance between fertilizer and seed, soil texture, and the salt index of the fertilizer applied.

## DIAGNOSTIC TECHNIQUES

### Deficiency Symptoms

The leaves of phosphorus-deficient plants most often appear dark bluish green, frequently with tints of purple or bronze. On corn, purpling occurs around the margins of the lower leaves, and the plant is short and dark green. Some corn hybrids exhibit a purple tinge on the lower stalk of young plants, a condition that can be confused with phosphorus deficiency. Reddening of corn leaves and stalks in the fall is not an indication of phosphorus deficiency, but of a process that occurs naturally as corn matures. Phosphorus-deficient alfalfa is stunted and dark bluish green, but purpling does not occur.

## Soil Analysis

Many methods exist for measuring available phosphorus in soils. The Bray  $P_1$  test, developed at the University of Illinois, is common in Wisconsin and throughout most of the Midwest. The interpretation of this test depends on the soil type and intended crop. See Extension publication A3030, *Optimum Soil Test Levels for Wisconsin*, for details. In general, soil-test phosphorus should be 10–30 ppm for field crops and somewhat higher for potato and some vegetable crops, including cabbage, carrot, melons, and tomato. Recommendations for phosphorus fertilizer vary with crop species, yield goal, and soil type. If soil phosphorus is below the optimum level, the amount of phosphate recommended will permit a gradual buildup (over 5–8 years) of the available supply. If soil phosphorus is high, the amount recommended will be less than the amount removed in the harvested portion of the crop, allowing some decrease in the soil test. For excessively high tests, elimination of part or possibly all of the phosphorus fertilizer allows the soil test to drop to the optimum range.

Table 2. Effect of various sources of row-applied phosphorus on the yield of corn (Arlington, WI).

FERTILIZER GRADE	SOURCE OF PHOSPHORUS IN COMMERCIAL 6-24-24 <sup>a</sup>	WATER SOLUBILITY	YIELD OF CORN <sup>b</sup>
		%	bu/a
Control	No phosphorus applied	—	96
6-24-24	Ammoniated superphosphate	60	109
6-24-24	Concentrated superphosphate	85	112
6-24-24	Monoammonium phosphate	92	112

<sup>a</sup>The 6-24-24 was applied at a rate of 167 lb/a to supply 40 lb/a of  $P_2O_5$  (17 lb/a P).

<sup>b</sup>The differences in yield between the various sources of phosphorus are not significant.



### Plant Analysis

Analysis of plant tissue gives a good indication of the phosphorus nutrition of the plant. Because phosphorus levels in the plant change with age and plant part, it is important to indicate the stage of maturity when sampling the plants. Table 3 interprets phosphorus levels for the major Wisconsin field crops. See Extension publication A2289, *Plant Analysis: A Diagnostic Tool*, for additional information.

### ADDITIONAL INFORMATION

These publications in the *Understanding Plant Nutrients* series are available from your county Extension office:

Soil and Applied Boron	(A2522)
Soil and Applied Calcium	(A2523)
Soil and Applied Chlorine	(A3556)
Soil and Applied Copper	(A2527)
Soil and Applied Iron	(A3554)
Soil and Applied Magnesium	(A2524)
Soil and Applied Manganese	(A2526)
Soil and Applied Molybdenum	(A3555)
Soil and Applied Nitrogen	(A2519)
Soil and Applied Phosphorus	(A2520)
Soil and Applied Potassium	(A2521)
Soil and Applied Sulfur	(A2525)
Soil and Applied Zinc	(A2528)

Table 3. Phosphorus plant-analysis interpretations for common Wisconsin field crops.

CROP	PLANT PART SAMPLED	TIME OF SAMPLING	INTERPRETATION				
			DEFICIENT	LOW	SUFFICIENT	HIGH	EXCESSIVE
			————— % —————				
Alfalfa	Top 6 inches	Bud	<0.20	0.20–0.25	0.26–0.70	0.71–1.00	>1.00
Corn	Whole plant	6–16 in	<0.20	0.20–0.39	0.40–0.60	0.61–1.20	>1.20
Corn	Earleaf	Silking	<0.16	0.16–0.24	0.25–0.50	0.51–0.80	>0.80
Oat	Top leaves	Boot stage	<0.15	0.15–0.20	0.21–0.50	0.51–0.75	>0.75
Soybean	First trifoliolate	Early flower	<0.15	0.15–0.25	0.26–0.50	0.51–0.80	>0.80

Copyright © 1996 University of Wisconsin-System Board of Regents and University of Wisconsin-Extension, Cooperative Extension

Authors: E.E. Schulte is professor emeritus and K.A. Kelling is professor of soil science, College of Agricultural and Life Sciences, University of Wisconsin-Madison and University of Wisconsin-Extension, Cooperative Extension. The authors wish to thank L.M. Walsh, professor emeritus of soil science, University of Wisconsin-Madison and University of Wisconsin-Extension, Cooperative Extension, for contributions from an earlier edition of this publication and P.P. Motavalli for editorial assistance. Produced by Cooperative Extension Publications, University of Wisconsin-Extension.

University of Wisconsin-Extension, Cooperative Extension, in cooperation with the U.S. Department of Agriculture and Wisconsin counties, publishes this information to further the purpose of the May 8 and June 30, 1914 Acts of Congress; and provides equal opportunities in employment and programming. If you need this information in an alternative format, contact the Office of Equal Opportunity and Diversity Programs or call Cooperative Extension Publications at 608-262-2655.

This publication is available from your Wisconsin county Extension office or from Cooperative Extension Publications, Rm. 170, 630 W. Mifflin St., Madison, Wisconsin 53703. Phone 608-262-3346.



# Soil and Applied Potassium

E.E. Schulte and K.A. Kelling

**S**oils commonly contain over 20,000 parts per million (ppm) of total potassium (K). Nearly all of this is a structural component of soil minerals and is unavailable to plants. Plants can use only the exchangeable potassium on the surface of soil particles and potassium dissolved in the soil water. This often amounts to less than 100 ppm.

Large quantities of potassium are removed with harvests of such plants as alfalfa, certain vegetables, other forages, and corn silage. Grain and seed harvests remove much less potassium. Most Wisconsin soils need relatively large quantities of applied potassium because of removal by crops and because Wisconsin soils have little native exchangeable potassium.

## POTASSIUM REACTIONS IN SOILS

### Forms of Soil Potassium

The three forms of soil potassium are unavailable, slowly available or fixed, and readily available or exchangeable potassium.

*Unavailable* soil potassium is contained within the crystalline structure of micas, feldspars, and clay

minerals. Plants cannot use the potassium in these insoluble forms. Over long periods, these minerals weather or break down, releasing their potassium as the available potassium ion ( $K^+$ ). This process is far too slow to supply the full potassium needs of field crops. However, trees and long-term perennials obtain a substantial portion of potassium from the weathering of minerals containing potassium.

*Slowly available* potassium is trapped between the layers or plates of certain kinds of clay minerals. This is sometimes called fixed potassium. Plants cannot use much of the slowly available potassium during a single growing season. However, the supply of fixed potassium largely determines the soil's ability to supply potassium over extended periods of time. The red soils of eastern Wisconsin are examples of soils that contain significant amounts of slowly available potassium.

*Readily available* potassium is that which is dissolved in soil water or held on the surface of clay particles. Dissolved potassium levels in the soil water are usually 5–10 ppm. Plants absorb dissolved potassium readily, and as soon as the concentration of potassium in the soil solution drops,

more is released into the solution from the exchangeable forms. Most soil tests for available potassium measure the readily available forms but not the unavailable and slowly available forms.

### Movement of Soil Potassium

Since clay and organic matter particles hold potassium ions in an exchangeable or available form, potassium does not leach from silty or clayey soils. Some leaching may take place in very sandy soils because sandy soils do not contain enough clay to hold the potassium.

Organic matter particles hold most positively charged nutrients tightly. Potassium is an exception because the attraction between potassium ions and organic matter particles is relatively weak. Consequently, some potassium leaches from organic soils (peats and mucks). Loss of potassium by leaching is one reason sandy and organic soils often test relatively low in available potassium, especially when tested in the spring. These soils require precise annual potassium applications, since it is not possible to build up high potassium reserves.

Table 1. Fertilizer sources of potassium.

NAME OF FERTILIZER	CHEMICAL FORMULA	FERTILIZER ANALYSIS EQUIVALENT N-P <sub>2</sub> O <sub>5</sub> -K <sub>2</sub> O	SALT INDEX
		%	
Potassium chloride (muriate of potash)	KCl	0-0-60 to 0-0-62	116
Potassium magnesium sulfate	K <sub>2</sub> SO <sub>4</sub> •2MgSO <sub>4</sub>	0-0-22	43
Potassium nitrate	KNO <sub>3</sub>	13-0-44	74
Potassium sulfate	K <sub>2</sub> SO <sub>4</sub>	0-0-50	46

Table 2. Potassium plant-analysis interpretations for common Wisconsin field crops.

CROP	PART SAMPLED	TIME OF SAMPLING	INTERPRETATION				
			DEFICIENT	LOW	SUFFICIENT	HIGH	EXCESSIVE
			%				
Alfalfa	Top 6 inches	Bud	<1.8	1.8–2.4	2.5–3.8	3.9–4.5	>4.5
Corn	Earleaf	Silking	<1.3	1.3–1.7	1.8–2.3	2.4–2.9	>2.9
Oat	Top leaves	Boot stage	<1.3	1.3–1.5	1.6–2.5	2.6–3.0	>3.0
Soybean	First trifoliate	Early flower	<1.3	1.3–1.7	1.8–2.5	2.6–4.5	>4.5

## FERTILIZER SOURCES OF POTASSIUM

The most common potassium fertilizer for use on field crops is potassium chloride, or muriate of potash. Both red- and white-colored potash are often available. (See Table 1 for the primary fertilizer sources of potassium.) These materials are equivalent as sources of potassium. The red color is due to iron impurities that have no effect on the availability of potassium or other nutrients. Most of the U.S. supply of potassium chloride is mined from vast underground deposits in Saskatchewan, although some is also mined in the western U.S. This is the least expensive source of potassium and is as effective as the other materials for most cropping situations, except where very high rates are to be used, where the burning quality of tobacco is important, or where the solids content of potatoes are of primary concern. When high rates of potassium are needed or when soil salinity is a problem, potassium fertilizer applications should be split or materials with a lower salt index, such as potassium sulfate ( $K_2SO_4$ ) or potassium magnesium sulfate ( $K_2SO_4 \cdot 2Mg SO_4$ ), should be used.

## DIAGNOSTIC TECHNIQUES

### Deficiency Symptoms

On corn, soybean, and other field crops, potassium deficiency appears as a yellowing or scorching of the margins of older leaves. In alfalfa, the deficiency appears as whitish-grey spots along the outer margin of the recently matured and older leaflets. As the deficiency becomes more severe, the affected area increases and the leaves or leaflets may become completely yellow and/or drop off. Because potassium is a very mobile element within the plant, deficiency appears on the older leaves first.

### Soil Analysis

Available potassium is estimated by measuring the solution and exchangeable potassium. Extension publication A3030, *Optimum Soil Test Levels for Wisconsin*, provides an interpretation of the exchangeable or available potassium test for Wisconsin soils. In general, available potassium should be 60–120 ppm for most field crops and somewhat higher for potato and some vegetable crops, including cabbage, carrot, melons, and tomato. Recommendations for potassium fertilizer vary with crop species, yield goal, and soil type. If soil tests are below

optimum levels, the amount of potash recommended will permit a gradual buildup (over 5–8 years) of the available supply. If soil potassium is high, the amount recommended will be less than the amount removed in the harvested portion of the crop, allowing some decrease in the soil test. For excessively high tests, elimination of part or possibly all of the potassium fertilizer allows the soil test to drop to the optimum range.

### Plant Analysis

Critical concentrations of potassium for economically important crops are fairly well known. Like nitrogen, the amount of potassium in the plant decreases as it matures; it is therefore important to know the plant's stage of growth to properly interpret the results of potassium analysis. Also, the potassium concentration usually decreases from top to bottom of the plant, so the portion of the plant sampled affects the interpretation as well. Interpretations of potassium levels in the leaf tissue of several major Wisconsin field crops are given in Table 2. See Extension publication A2289, *Sampling for Plant Analysis: A Diagnostic Tool*, for additional information.

Authors: E.E. Schulte and K.A. Kelling are professors of soil science, College of Agricultural and Life Sciences, University of Wisconsin-Madison and University of Wisconsin-Extension, Cooperative Extension. The authors wish to thank L.M. Walsh, professor of soil science, University of Wisconsin-Madison and University of Wisconsin-Extension, Cooperative Extension, for contributions from an earlier edition of this publication and P.P. Motavalli for editorial assistance. Produced by Cooperative Extension Publications, University of Wisconsin-Extension.

University of Wisconsin-Extension, Cooperative Extension, in cooperation with the U.S. Department of Agriculture and Wisconsin counties, publishes this information to further the purpose of the May 8 and June 30, 1914 Acts of Congress. An Equal Employment Opportunity/Affirmative Action employer, University of Wisconsin-Extension provides equal opportunities in employment and programming, including Title IX requirements.

This publication is available from your Wisconsin county Extension office or from Cooperative Extension Publications, Rm. 245, 30 N. Murray St., Madison, Wisconsin 53715. Phone 608-262-3346.

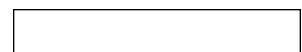

# Plant Nutrient Deficiency Symptoms

Plants that are not supplied with adequate amounts of one of the essential plant nutrients often develop specific visual characteristics that can be associated with a deficiency of that nutrient. These specific visual characteristics or nutrient deficiency symptoms are one method of identifying nutrient deficiencies in plants.

When visual symptoms are used to diagnose plant problems, it is essential to recognize that nutrient deficiencies are only one of many factors that can affect the overall appearance of plants. Other factors such as drought stress and other weather-related events, plant diseases, insect damage, nutrient toxicities, and injury from fertilizer or pesticide applications can also influence plant characteristics and appearance.

Nutrient deficiency symptoms in several of the major agricultural crops in Wisconsin are described below.

Crop	Nutrient	Symptoms
Corn	Nitrogen	Yellowing or "firing" of the lower leaves. Yellowing starts at the tip of the leaf and proceeds up the midrib. Leaf margins may remain green.
	Phosphorous	Purpling or reddening along the lower leaves early in the growing season. Discoloration usually disappears before corn reaches 18 to 24 inches in height.
	Potassium	Yellowing or browning of the lower leaves. Yellowing or browning occurs along the margin or edge of the leaf. Midrib will remain green.
	Sulfur	Plants are stunted and have an overall lighter or yellowish color. Symptoms are not localized and the entire plant is spindly and pale in color. Yellowing between veins in leaves is sometimes apparent. Deficiency is most likely on soils with low organic matter located away from industrial areas.
	Zinc	Broad bands of bleached or yellow tissue on each side of the midrib beginning at the base of the leaf. Midrib and leaf margins remain green. Zinc deficiency is the most common micronutrient deficiency in corn, and is most likely on light colored eroded or scalped soils, especially sands. High pH, medium textured soils can also be zinc deficient.
Alfalfa	Potassium	White spots around the outer edges of lower leaves. With severe deficiency, size and number of spots increase, and leaves eventually become yellow and die. Lower leaves may drop off of plant.
	Boron	Top leaves turn yellow with a reddish cast. Bunched or bushy appearance of plants. Growing tips of plants are yellow and severely retarded while side stems and lower leaves remain green. Boron deficiency is the major micronutrient problem in alfalfa production, and is most likely on soils with low organic matter content. Deficiency is promoted by dry weather.
	Phosphorus	No distinct symptoms except for stunted growth. In extreme deficiency, plants may develop a bluish-green color.
	Sulfur	Stunted plants, light yellow color, spindly growth. Deficiency is most likely on sandy soils with low organic matter contents.
	Soybeans	Potassium

<b>Crop</b>	<b>Nutrient</b>	<b>Symptoms</b>
	Manganese	Areas between leaf veins turn pale green and then yellow. Veins remain green and in sharp contrast to pale inter-veinal areas. Deficiency is most likely on high pH soils.
Potato	Nitrogen	Pale green color, edges of leaflets roll upward. In severe deficiency, leaf margins lose green color and curl upward at the edges.
	Potassium	Bronzing of leaf surfaces and edges of leaves turn brown.



## USING PLANT ANALYSIS AS A DIAGNOSTIC TOOL<sup>1/</sup>

K.A. Kelling, S.M. Combs, and J.B. Peters<sup>2/</sup>

The information provided through plant analysis helps farmers with decisions on fertilizer effectiveness, the need for additional nutrients, and planning fertilizer programs for future years. If used properly, plant analysis can be an important guide to efficient crop production because it provides a nutritional profile of the growing plant at the time that the sample was taken.

### Essential Elements

Plants require 17 elements for normal vegetative growth and reproduction. In addition, there are some elements that improve plant growth in some situations but are not essential. Table 1 shows the main function of the essential elements and their primary sources. Different amounts of each element are required by different plant species. Plant growth is restricted when: 1) not enough of one or more elements is present; 2) too much of one or more elements is present, including toxic levels of nonessential elements such as aluminum, arsenic, selenium, or sodium; 3) the levels of one or more elements are adequate but out of balance with other elements.

The first result of nutrient deficiency, toxicity, or imbalance is a reduction in plant growth. If the condition persists, visible symptoms of deficiency or toxicity appear, and plant yield is reduced even further. A nutrient deficiency or imbalance may result in a yield reduction without showing visible symptoms but is detectable by plant analysis.

---

<sup>1/</sup> Presented at the Fertilizer Dealer Meetings, November 28 to December 7, 2000.

<sup>2/</sup> Extension Soil Scientist and Professor, Dept. of Soil Science, Univ. of Wisconsin-Madison; Director, UW-Madison Soil and Plant Analysis Lab; Director; Soil and Forage Analysis Lab,

Marshfield, WI.

**Table 1. Concentration, function, and primary source of essential plant elements.**

Element (chemical symbol)	Approximate concentration in plants	Main function in plants	Primary sources
<u>Essential plant nutrients</u>			
Carbon (C)	45%	Part of all organic compounds	Carbon dioxide in air
Hydrogen (H)	6%	Forms main structural components	Water
Oxygen (O)	43%	Forms main structural components	Water, air
Nitrogen (N)	1-6%	Components of proteins, chlorophyll, nucleic acids	Soil organic matter; microbial fixation of atmospheric nitrogen (legumes)
Phosphorus (P)	0.05-1%	Energy transfer; metabolism, nucleic acids, phospholipids	Soil organic matter, soil minerals
Potassium (K)	0.3-6%	Protein synthesis; translocation of carbohydrates; enzyme activation; universal cation	Soil minerals
Calcium (Ca)	0.1-3%	Structural component of cell walls; cell elongation; affects cell permeability	Soil minerals, limestone
Magnesium (Mg)	0.05-1%	Component of chlorophyll; enzyme activator; metabolism; cell division	Soil minerals; dolomitic limestone
Sulfur (S)	0.05-1.5%	Constituent of proteins; involved in respiration and nodule formation	Soil organic matter; rainwater
Iron (Fe)	10-1000 ppm	Chlorophyll synthesis; oxidation-reduction reactions; enzyme activator	Soil minerals; soil organic matter
Manganese (Mn)	5-500 ppm	Oxidation-reduction reactions; nitrate reduction; enzyme activator	Soil minerals
Copper (Cu)	2-50 ppm	Enzyme activator; nitrate reduction; respiration	Soil minerals; soil organic matter

**Table 1. (continued).**

Element (chemical symbol)	Approximate concentration in plants	Main function in plants	Primary sources
<u>Essential plant nutrients (continued)</u>			
Zinc (Zn)	5-100 ppm	Enzyme activator; regulates pH of cell sap	Soil minerals; soil organic matter
Boron (B)	2-75 ppm	Cell maturation and differentiation; translocation of carbohydrates	Soil organic matter; tourmaline
Molybdenum (Mo)	0.01-10 ppm	Nitrate reduction; fixation of atmospheric nitrogen by legumes	Soil organic matter; soil minerals
Chlorine (Cl)	0.05-3%	Photochemical reactions in photosynthesis	Rainwater
Nickel (Ni)	0.1-10 ppm	Metal component of urease; seed fertility	Soil minerals
<u>Enhancing or beneficial nutrients</u>			
Sodium (Na)	0.05-2%	Influences mesophyll chloro- plasts of some C <sub>4</sub> halophytes; substitutes for K; increases cell expansion	Soil minerals
Silicon (Si)	0.1-10%	May affect spikelet fertility of some species; contributes to cell wall stability	Soil minerals
Cobalt (Co)	0.01-10 ppm	Nitrogen fixation, component of vitamin B <sub>12</sub>	Soil minerals
Selenium (Se)	2-1000 ppm	Component of enzyme co- factor responsible for peroxide in animals; essential for animals; insect defense	Soil minerals
Aluminum (Al)	10-1000 ppm	May alleviate toxicities from other elements	Soil minerals

## What is Plant Analysis

Plant analysis is the quantitative determination of many of the essential nutrients in plant tissue. Carbon, hydrogen, and oxygen are not analyzed routinely because they come from air or water and plant analysis is not helpful for these elements. Chlorine is normally sufficient under field conditions, but it may become excessive in saline soils. It is usually analyzed in special cases only. Similarly, molybdenum and nickel deficiency or toxicity are rare, and these elements are not analyzed routinely. Thus, plant analysis usually refers to analysis of nitrogen (N), phosphorus (P), potassium (K), calcium (Ca), magnesium (Mg), sulfur (S), iron (Fe), manganese (Mn), copper (Cu), zinc (Zn), and boron (B). Aluminum (Al) and sodium (Na) are sometimes included even though they are not essential elements. Aluminum can be toxic in very acid soils, and sodium can improve the quality of some crops such as beets and celery.

Plant analysis is distinguished from tissue testing in that it is a quantitative laboratory analysis, whereas tissue testing refers to semi-quantitative or quantitative “quick” tests of crushed tissue or plant sap carried out in the field for trouble-shooting purposes.

The general relationship between plant tissue nutrient levels and crop growth is shown in Figure 1. When a nutrient is deficient, addition of that nutrient results in increased crop growth and usually an increase in the concentration of that element in the plant. As the level of the deficient nutrient increases, crop growth increases until some maximum yield is reached. Further additions of the element will cause the concentration of that element in the plant to rise more rapidly because it is not being diluted by added dry matter accumulation. Eventually, toxicity of that element may occur.

## Uses of Plant Analysis

Plant analysis has proven useful in confirming nutrient deficiencies, toxicities or imbalances, identifying “hidden hunger,” evaluating fertilizer programs, determining the availability of elements not tested for by other methods, and studying interactions among nutrients.

**Determining nutritional problems** — One of the major uses of plant analysis is troubleshooting crop problems. Plant analysis defines nutrient problems more precisely than does an examination of deficiency symptoms, soil tests, or quick tissue tests. In addition to confirming suspected deficiencies, plant analysis can also detect toxicities or hidden deficiencies when visible symptoms are not evident. The second most common use is crop monitoring to evaluate potential nutritional problems while they can still be corrected or so they can be avoided in subsequent seasons.

**Evaluating fertilizer programs** — Scientists and others use plant analysis to study uptake from fertilizer or other nutrient sources and to evaluate different methods and times of fertilizer application. Farmers can also use plant analysis to determine whether their fertilizer program is performing according to expectations. Adding nutrients is no guarantee that they have been utilized as other factors may restrict uptake. Plant analysis can establish treatment effectiveness.

**Determining nutrient availability where soil tests are not available** — Most laboratories routinely test soils for lime needs, phosphorus, and potassium. Some have optional tests for calcium, magnesium, and some of the minor elements. However, reliable soil tests have not been developed for all of the elements. Furthermore, a test for iron developed in one state is not necessarily applicable to the soils of another state until the test has been calibrated for the soils in that state. Plant analysis can be particularly advantageous in determining the availability of nutrients for which there are no reliable soil tests, or for those areas where soil test calibration has not been done.

Deficiencies of most micronutrients and sulfur are identified more accurately by plant analysis than by soil test. The soil test commonly used for sulfur, for example, measures only the amount of sulfate-sulfur present in the sampled area at that point in time. It does not include possible contributions from other sources such as rainfall. A high sulfur soil test indicates adequate sulfur is present, but a low test may mean either the sulfur is not there or it was not measured by the soil test. Plant analysis gives an accounting of all of the sulfur available to the plant.

**Studying nutrient interactions** — Plant analysis helps detail the relationships among essential elements. This use may have rather limited applicability for most routine users.



## Plant Analysis Complements Soil Testing

Sometimes adequate nutrient levels may be present in the soil, but because of other problems—such as cool temperatures at planting, insect feeding, or root damage—inadequate amounts of nutrients get into the plant. Plant analysis along with soil tests can help pinpoint the problem. For example, plant analysis of corn ear leaf samples from central Wisconsin may show high levels of manganese present, but the soil analysis identifies the actual problem is very acidic soil resulting in excessive manganese availability.

Soil tests normally are calibrated for the average depth of plowing. If a subsoil is high in a particular nutrient, the subsoil contribution will go undetected unless a subsoil sample is also analyzed. A plant analysis will not tell how much of the nutrient in the plant came from the subsoil, but it will measure the integrated effect of the entire root volume, which may include several cubic feet of soil.

The results of plant analysis alone cannot be used to make fertilizer recommendations. Although plant analysis can provide substantial additional information, plant samples should be accompanied by soil samples taken from the same area as the plants. If the plant and soil samples are taken from an abnormal area of a field, the results are applicable to that area only. Unless a field is sampled in detail, the soil sample accompanying a plant sample usually is not very representative of the entire field. Emergency recommendations for an abnormal area in a field can be made from soil and plant analyses, but field-scale recommendations should be based on appropriate soil sampling and analysis (see Extension Publication #A2100, “Sampling Soils for Testing”).

## Limitations of Plant Analysis

**Interpretation difficulties** — In general, good relationships can be developed between soil nutrient supply, nutrient levels in the plant, and crop yield for a given plant part, time of sampling, and location in any one year. However, differences in location, variety, time, and management often cause variations in these relationships and make them difficult to interpret. Nutrient levels in plants differ depending on the plant part sampled, stage of maturity, hybrid, and climatic conditions. Interpretations of plant analysis must take these factors into consideration. For this reason, most plant analysis interpretations are based on a specific plant part sampled at a definite stage of development. Greater detail on plant sampling for tissue analysis is provided in Extension Publication A2289 “Sampling for Plant Analysis.”

For corn, the ear leaf at silking is most commonly used for diagnostic analysis. In most situations, this is too late for remedial treatment. The results of the analysis, then, can only be used to guide future management decisions. In many cases, it may be possible to identify nutrient disorders at an earlier stage of crop development if plants from a normal growing field at the same growth stage are also analyzed for comparison. The normal/abnormal

comparison is especially important for plants in early growth stages since sampling the entire plant tends to mask the differences in key plant parts, or for specialty crops that may not have an adequate calibration database developed.

**Interrelationship of other factors** — Interpreting plant analysis assumes that the chemical composition of the plant reflects its nutrient supply in relation to the growth of the crop. There are situations, however, when the nutrient concentrations in the plant are not the primary factor responsible for the amount of plant growth obtained. For example, any factor that limits growth may cause non-limiting nutrients to accumulate at higher than normal concentrations in the plant. In this case, there is not necessarily a direct relationship between nutrient supply and plant growth.

**Progressive deficiencies** — Plant analysis usually detects only the one element that most inhibits plant growth. Rarely are two or more elements acutely deficient at the same time. A corn plant, for example, may be deficient in K, but because K is limiting growth, there may be sufficient P for the reduced amount of dry-matter production even if the soil P supply is low. However, when K is added as a remedial treatment, dry-matter production increases sharply; then P becomes deficient. Nitrogen stress, on the other hand, can limit the uptake of phosphorus and some of the micronutrients to the extent that they appear to be “low.”

**Secondary deficiencies** — If plant growth is limited because of something other than a nutrient shortage (i.e., insect feeding or lack of water), the nutrient deficiency symptoms expressed may be a secondary effect. Adding more nutrient in this case will not increase nutrient uptake or plant growth.

**Sample contamination** — Contamination of a plant sample with soil particles or pesticide residue can lead to erroneously high results for iron, aluminum, manganese, zinc, or copper. Washing the sample to remove contamination can introduce other contaminants if a detergent or tap water are used. Appreciable potassium can be lost by washing.

**Sample deterioration** — Decomposition of a plant sample before it reaches the laboratory will result in a loss of carbon (as CO<sub>2</sub> through respiration and microbial activity) and the concomitant increased concentration of most other elements, thereby giving erroneously high readings. This can be prevented by refrigerating the sample until it is delivered to the laboratory or air-drying to 15 to 25% moisture.

## Interpretation of Plant Analyses

**Critical value and sufficiency range approaches** — For most diagnostic purposes, plant analyses are interpreted on the basis of “critical or sufficiency levels” for each nutrient. The critical level has been defined as that concentration below which yields decrease or deficiency symptoms appear. For many nutrients, yield decreases even before visible deficiency symptoms are observed. Because the exact concentration of a

nutrient below which yields decline is difficult to determine precisely, some define the critical level as the nutrient concentration at 90 or 95% of maximum yield.

The nutrient composition of a plant changes as the plant matures and with the portion of the plant sampled; therefore, critical levels are defined for a specific plant part at a specified stage of maturity. For corn, the ear leaf from the period from tasseling to silking is most commonly used. For most crops, there is an optimal range of concentration over which yield will be maximized rather than a single point. Growers, therefore, usually strive for operating in the sufficiency range that corresponds to the yield plateau illustrated in Figure 1. Most nutrients have fairly broad sufficiency ranges.

Nutrient ranges representing deficient, low, sufficient, high, and excessive concentrations for corn and alfalfa used by the University of Wisconsin Soil and Plant Analysis Lab. are given in Table 2. For some nutrients, excessive nutrient levels have not been well-defined because growth is not depressed by excessive uptake. These ranges are useful guidelines for interpreting plant analyses, but they must not be used dogmatically. Knowledge of hybrid requirements, unusual soil or climatic conditions, or other extenuating information should be considered.

**DRIS or nutrient ratio approach** — The Diagnosis and Recommendation Integrated System (DRIS) simultaneously considered nutrients on a ratio basis in relation to crop growth. The DRIS approach to interpreting the results of plant analysis involves creating a database from the analysis of thousands of samples of a specific crop. The nutrient ratios corresponding to the highest yielding portion of the population are established as the standard (norms) and used as the basis for comparison. A ratio of plant nutrient concentrations by itself cannot be used to diagnose plant problems, but combinations of different nutrient ratios can be combined mathematically to determine what nutrients are most likely to limit yield. The results of such calculations are the “DRIS indices.”

An index of 0 is considered optimum; however, although finer-tuning may be possible, DRIS indices are normally calibrated so that those within the range of about -15 to +25 are considered normal and in balance. A DRIS index less than -25 indicates a likely deficiency, whereas those between -15 and -25 represent a possible deficiency. Values greater than +100 may be an indication of possible nutrient excess. The greater the magnitude of the nutrient index, either positive or negative, the more likely that element is out of balance in the plant.

The principal advantages of the DRIS system are that stage of maturity, plant part, and cultivar are less important than they are for the critical level or sufficiency range approaches to interpreting plant analyses. Thus, by using DRIS as a interpretative approach, it is possible to sample alfalfa at the pre-bud stage and obtain meaningful results, rather than waiting until first flower.

**Table 2. Interpretive ranges for plant nutrients used by the University of Wisconsin Soil and Plant Analysis Lab.**

Nutrient	Tissue nutrient interpretative level				
	Deficient	Low	Sufficient	High	Excessive
<u>Corn ear leaf at tasseling to silking</u>					
N, %	<1.75	1.75-2.76	2.76-3.75	>3.75	--
P, %	<0.16	0.16-0.24	0.25-0.50	>0.50	--
K, %	<1.25	1.25-1.74	1.75-2.75	>2.75	--
Ca, %	<0.10	0.10-0.29	0.30-0.60	0.61-0.90	>0.90
Mg, %	<0.10	0.10-0.15	0.16-0.40	>0.40	--
S, %	<0.10	0.10-0.15	0.16-0.50	>0.50	--
Zn, ppm	< 12	12-18	19-75	76-150	>150
B, ppm	<2.0	2.0-5.0	5.1-40.0	41-55	>55
Mn, ppm	< 12	12-18	19-75	>75	--
Fe, ppm	< 10	10-49	50-250	251-350	>350
Cu, ppm	--	<3	3-15	16-30	>30
<u>Top 6 inches of alfalfa at first flower</u>					
N, %	<1.25	1.25-2.50	2.51-4.00	>4.00	--
P, %	<0.20	0.20-0.25	0.26-0.45	>0.45	--
K, %	<1.75	1.75-2.25	0.26-3.40	3.41-4.25	>4.25
Ca, %	--	<0.70	0.70-2.50	>2.50	--
Mg, %	<0.20	0.20-0.25	0.26-0.70	>0.70	--
S, %	<0.20	0.20-0.25	0.26-0.50	>0.50	--
Zn, ppm	--	<20	20-60	60-300	>300
B, ppm	< 20	20-25	26-60	>60	--
Mn, ppm	< 15	15-20	21-100	101-700	>700
Fe, ppm	--	<30	30-250	>250	--
Cu, ppm	--	<3.0	3.0-30.0	>30.0	--

DRIS norms are not available for all crops and some users of the DRIS system tend to interpret the results too dogmatically. Some regard every negative index as representing a deficiency and pay no attention to positive indices. Since not all of the nutrient norms used to develop DRIS indices have been evaluated under field conditions, experience has shown that the evaluations should not be made disregarding nutrient concentrations altogether. The University of Wisconsin recommends that the two interpretative approaches be used together.

**PASS** — The Plant Analysis with Standardized Scores (PASS) was developed at the University of Wisconsin to combine the strengths of the sufficiency range (SR) and DRIS methods. The SR provides easily interpreted, categorical, independent nutrient indices. The DRIS gives difficult to calculate, easily interpreted, numerical, dependent nutrient indices, and a ranking of the relative deficiencies. The strengths of the SR are the weaknesses of the DRIS and vice-versa. The PASS system combines an independent nutrient section and a dependent nutrient section. Both types of indices are expressed as a standardized score and can be combined to make more effective interpretations. Research has demonstrated that PASS results in more correct diagnoses than either of the other two systems. To date, however, the PASS system has been developed only for alfalfa, corn, and soybean.

## Summary

Plant analysis is a powerful tool for confirming nutrient deficiencies, toxicities and imbalances, identifying “hidden hunger,” evaluating fertilizer programs, studying nutrient interactions, and determining the availability of elements for which reliable soil tests have not been developed. The results can be misleading, however, if initial plant sampling, handling, and analysis of the sample are faulty. Experience with interpreting the overall plant analysis report is essential because of the many interacting factors that influence the concentration of any one element in plant tissue. After assessing the status of each nutrient by both interpretative methods, one needs to review possible causes of the effects observed. Thus, cropping history, sampling techniques, soil test data, environmental influences, and a knowledge of nutrient concentrations all need to be considered in the final diagnosis. If properly done, plant analysis can point the way toward more efficient nutrient management and crop production programs.



**PLANT ANALYSIS INFORMATION SHEET**

Date Rec'd (Lab Use Only)		NAME AND ADDRESS			METHOD OF PAYMENT	
Name		Amount paid			or Acct. ID	
Address		Cash or Check No.			PO#	
City		State			Credit Card	
County Code _____		County sample(s) came from:			Credit Card No. _____ Exp. / _____	
Sample No.	Field ID	Stage of growth Interpretations only for those listed. (Choose number on back)	Plant part sampled (Choose letter on back)	Crop	Plant appearance (Circle one)	Soil submitted for routine test (pH, OM, P and K) (Circle one)
					Normal Abnormal	Yes No
					Normal Abnormal	Yes No
					Normal Abnormal	Yes No
					Normal Abnormal	Yes No
					Normal Abnormal	Yes No
					Normal Abnormal	Yes No
					Normal Abnormal	Yes No
					Normal Abnormal	Yes No
					Normal Abnormal	Yes No
					Normal Abnormal	Yes No
					Normal Abnormal	Yes No

In addition to routine test (pH, organic matter, phosphorus, and potassium), check soil special test(s) if requested: There is an added charge per test. Report will list fields individually unless designated otherwise:

- DRIS indices available for: alfalfa, apple, corn, celery, lettuce, tomato, oat, potato, grain sorghum, tomato and wheat
- PASS indices available for: alfalfa, corn and soybean
  - Best information for non-diagnostic stage of growth/plant part can be obtained by comparing good and bad appearing plants from the same field.

If you would like to have results emailed please provide email address below:  
Email to: \_\_\_\_\_

<p><u>Check special test(s) desired:</u>                  Calcium/Magnesium (Ca/Mg) _____                  Boron (B) _____                  Manganese (Mn) _____                  Sulfur (SO4-S) _____                  Zinc (Zn) _____</p>	<p><u>List fields</u></p> <p>_____</p> <p>_____</p> <p>_____</p> <p>_____</p>
---	---

Comments, special instructions, billing information (if different from above):

<u>Field Crops</u>	<u>Stage of Growth</u>	<u>Plant Part Sampled</u>	<u>Number of Plants</u>
Alfalfa, red clover, birdsfoot trefoil, crown vetch	1 Bud to first flower	A Top 6"	30-40
Alfalfa hay, red clover hay	2 Harvest	B Whole plant	15-20
Corn, field	3 12" tall	C Whole plant	10-15
	4 Pre-tassel	D Leaf below whorl	15-20
	5 Tassel to silk	E Ear leaf	15-20
	6 Ensiled/chopped	F Whole plant	10-15
Corn, sweet	7 Tassel to silk	G Ear leaf	15-20
Beans, soybeans, dry lima, snapbeans, peas (canning, chick peas)	8 Prior to or at initial flowering	H 4 <sup>th</sup> petiole and leaflet or 4 <sup>th</sup> petiole only	20-25
Potato	9 Prior to or at initial flowering	I 4 <sup>th</sup> petiole and leaflet or 4 <sup>th</sup> petiole only	40-50
	10 Tuber bulking	J 4 <sup>th</sup> petiole and leaflet or 4 <sup>th</sup> petiole only	40-50
Wheat	11 Tillering	K Newest fully developed leaf	30-40
Wheat, barley, rye, canary grass, triticale, brome grass, oat, orchard grass	12 Prior to heading	L Newest fully developed leaf	30-40
Sorghum, grain	13 Prior to heading	M 2 <sup>nd</sup> fully developed leaf	15-20
Sorghum-sudan	14 Prior to heading	N Newest fully developed leaf	15-20
<u>Fruits</u>	<u>Stage of growth</u>	<u>Plant part sampled</u>	<u>Number of Plants</u>
Apple, cherry (sour)	15 Current season's shoots	O Fully developed leaf at midpoint of new shoots	10-20
Strawberry	16 At renovation before mowing	P Fully developed leaflets and petioles	10-20
Raspberry	17 August 10 to September 4	Q 6 <sup>th</sup> and 12 <sup>th</sup> leaf blade and petiole from trifoliolate	10-20
Cranberry	18 August 15 to September 15	R Current season's growth above berries	35-50
<u>Vegetables</u>	<u>Stage of growth</u>	<u>Plant part sampled</u>	<u>Number of Plants</u>
Onion	19 Midseason	S Tops, no white	10-20
Carrots, celery, ginseng, cauliflower	20 Midseason	T Youngest mature leaves	10-20
Tomato	21 Midseason	U Newest fully developed leaf	10-20
Cabbage, lettuce	22 Midseason	V Wrapper leaf	10-20
Pepper	23 Prior to or at early fruit development	W Petiole and leaflet	10-20



# Nutrient Deficiencies and Application Injuries in Field Crops







Nitrogen deficiency

## NITROGEN (N)

Nitrogen deficiency causes pale, yellowish-green corn plants with spindly stalks. Because nitrogen is a mobile nutrient in the plant, symptoms begin on the older, lower leaves and progress up the plant if the deficiency persists. Symptoms appear on leaves as a v-shaped yellowing, starting at the tip and progressing down the midrib toward the leaf base. The condition is favored by cold or saturated soil; dry soil, particularly after mid-season; large amounts of low-nitrogen residue; sandy soil; inadequate fertilization; leaching from heavy rainfall; and flooded or ponded soil when the temperature is warm.

## PHOSPHORUS (P)

Phosphorus deficiency is usually visible on young corn plants. It readily mobilizes and translocates in the plant. Plants are dark green with reddish-purple leaf tips and margins on older leaves. Newly emerging leaves will not show the coloration. Phosphorus-deficient plants are smaller and grow more slowly than do plants with adequate phosphorus. Deficiency symptoms nearly always disappear when plants grow to three feet or taller. Some corn hybrids tend to show purple colors at early stages of growth even though phosphorus nutrition is adequate, yet other hybrids do not show the color symptoms even though inadequate phosphorus severely limits yields. Phosphorus deficiency is favored by cold soils that are too wet or too dry; phosphorus applied where plant roots cannot absorb it; restricted root growth in compacted soils; and roots injured by insects, herbicides, fertilizers, or cultivation.



Phosphorus deficiency



## POTASSIUM (K)

Potassium deficiency is first seen as a yellowing and necrosis of the corn leaf margins, beginning on the lower leaves. Symptoms usually don't appear for some time after planting (about 4 to 6 weeks, around the V6 growth stage). If the deficiency persists, symptoms progress up the plant because potassium is mobile in the plant and translocates from old to young leaves. When potassium deficiency is severe, older leaves turn yellow with tissue necrosis along the margins, but the upper new leaves may remain green. Potassium-deficient corn tends to lodge late in the growing season due to poor stalk strength. Potassium deficiency is favored by conditions that limit early root growth, development, and activity – root pruning, dry soil, compacted soil, seed trench side-wall smearing; wet soil; sandy soil; organic soil; strongly geologically-weathered soils; potassium applied where plant roots cannot absorb it; large amounts of potassium removed by a preceding crop; and some tillage systems such as ridge-tillage and no-tillage, especially in a dry year and on soil with low levels of subsoil potassium.



Potassium deficiency



Phosphorus deficiency



Phosphorus deficiency





Sulfur deficiency

## SULFUR (S)

Sulfur deficiency shows on small corn plants as a general yellowing of the foliage, similar to nitrogen deficiency. Yellowing of the younger upper leaves is more pronounced with sulfur deficiency than with nitrogen deficiency because sulfur is not easily translocated in the plant. Stunting of plants and delayed maturity also are symptoms. Interveinal chlorosis of the youngest leaves may occur. This deficiency is favored by acid sandy soils; low soil organic matter; and cold-dry soils in the spring that delay the release of sulfur from organic matter. Early-season symptoms may disappear as temperature and moisture conditions improve for mineralization of sulfur from organic matter, or corn roots reach plant-available sulfate contained within the soil profile.



Calcium deficiency

## CALCIUM (Ca)

Calcium deficiency is rare in corn. It has not been verified in Iowa. If deficient, leaf tips stick to the next lower leaf, creating a ladder-like appearance. Plants may be severely stunted because calcium is immobile in the plant; it is not translocated from old to growing plant tissue that needs calcium. Low soil pH and acid soil problems like excessive levels of soluble aluminum and manganese are more likely to occur before calcium deficiency symptoms appear. Calcium deficiency is favored by very low soil pH, below 5.0 on mineral soils and 4.8 on organic soils; non-limed, highly weathered acid soils; or by very high magnesium and potassium and very low calcium on the cation. exchange complex.

## MAGNESIUM (Mg)

Magnesium deficiency is first seen as yellow to white interveinal striping of the lower corn leaves. Dead, round spots sometimes follow, which give the impression of beaded streaking. Older leaves become reddish-purple, and the tips and edges may become necrotic if the deficiency is severe. This happens because magnesium is mobile in the plant and is translocated from old to new plant tissue. Magnesium deficiency is favored by very acid, sandy soils in regions of moderate to high rainfall where magnesium has been extensively leached from the soil profile. On soils marginal in crop available magnesium, deficiency can be induced by high soil potassium levels or high rates of applied potassium.



Magnesium deficiency





Zinc deficiency

### ZINC (Zn)

Zinc deficiency in corn causes interveinal, light striping or a whitish band beginning at the base of the leaf and extending towards the tip. The margins of the leaf, the midrib area, and the leaf tip usually remain green. Plants are stunted because internodes are shortened. Zinc is relatively immobile in the plant. Severe zinc deficiency may result in new leaves that are nearly white, an effect termed "white bud." Plants frequently outgrow zinc deficiency unless it is severe. Zinc deficiency is favored by high soil pH; low organic matter soils with high soil pH; cool, wet soil; and high phosphorus fertilizer applications on soils that are marginal in zinc availability, although high soil phosphorus levels alone don't create zinc deficiency.



Iron deficiency

### IRON (Fe)

Iron deficiency turns the interveinal area along the length of the upper leaves pale green to nearly white. It has not been verified in Iowa. Iron is immobile and is not translocated from old to young plant tissue. This deficiency is rare on corn because of its low iron requirement, and it only occurs on high pH soils. Iron deficiency is favored by calcareous soils with a high soil pH in the surface soil and by cold, wet, poorly aerated soils.



Manganese deficiency

### MANGANESE (Mn)

Manganese deficiency symptoms are not clear-cut. It has not been verified on corn in Iowa. Newly emerged leaves become olive-green and may become slightly streaked. If the condition is severe, deficient leaves become elongated with white streaks that turn brown in the center, deteriorate and fall out. Manganese is relatively immobile in the plant. Manganese deficiency is favored by high soil pH; sandy soils that are high in organic matter, and peat or muck soils.

### MOLYBDENUM (Mo)

Molybdenum deficiency (no picture) is rarely, if ever, found in corn. It has not been identified in Iowa. If it occurs, however, older leaves become necrotic at the tip, along the margins, and between the veins. This condition is favored by very low soil pH and strongly weathered soils, conditions not normally found in the Midwest.

### BORON (B)

Boron deficiency (no picture) is rare in corn. It has not been verified in Iowa. Leaves have small dead spots and are brittle. Boron is not readily translocated in the plant and as a result upper internodes do not elongate. Tassels and ear shoots are reduced and may not emerge. Corn is very sensitive to boron fertilizer. Boron toxicity can result if fertilizer is applied at rates above recommendations, or row applied. Deficiency is favored by drought; sandy soils that are low in organic matter; and high soil pH. Drought reduces the release of boron from organic matter, but lack of water also delays ear shoot emergence and possible pollination; therefore, symptoms may occur simultaneously and could be confused with each other.

### COPPER (Cu)

Copper deficiency (no picture) is rare in corn. It has not been verified in Iowa. The youngest leaves are yellow as they come out of the whorl, and the tips may die. Copper is relatively immobile in the plant. Leaves become streaked, causing an appearance that is similar to iron deficiency. The stalk is soft and limp. Some necrosis of older leaf edges occurs as it does in cases of potassium deficiency. Copper deficiency is favored by organic soils (very high soil organic matter) and by high soil pH (above 7.5).





Vapor damage

## ANHYDROUS AMMONIA VAPOR (NH<sub>3</sub>)

Anhydrous ammonia vapor damage to leaves can occur when sidedressing ammonia if the applicator knives are near or above the soil surface and there is escape of ammonia during application. Corn plants usually outgrow the damage if only a portion of the leaves is damaged.



Granular Urea

## GRANULAR UREA

Granular urea applied on top of growing corn results in some granules falling in the whorl and lodging in leaf axils. Tan to white burn spots and damaged tissue areas appear on leaves where granules lodge. Plants absorb urea through their leaves. If the amount of urea absorbed is excessive, the leaf margins turn white. Although this is a symptom of toxicity, plants outgrow the injury unless a large amount of material lodges in the whorl and the plant leaves are severely damaged or the growing point is injured.

## ANHYDROUS AMMONIA INJURY

Anhydrous ammonia injury results in uneven corn seedling emergence, slow plant growth, plants with a spiky and blue-green color appearance, and wilting of seedlings in dry weather. Ammonia injury is detected more frequently in dry weather because roots are slow to develop; if a portion of the root system is destroyed, it limits water uptake. Root injury browns the roots. If severely injured, roots die and turn black back to the seed.



Anhydrous Ammonia Injury



**NON-PRESSURE NITROGEN SOLUTIONS (UREA-AMMONIUM NITRATE SOLUTION, 28 OR 32% UAN)** Non-pressure nitrogen solutions broadcast on top of growing corn can burn leaf tissue. The solutions tend to move towards the leaf tip and margins, resulting in greater burning of those leaf areas. Corn plants usually outgrow the damage if only a portion of the leaves is injured. However, leaf damage and potential yield impacts increase with higher application rates and larger plants.



Broadcast solution nitrogen

## UREA

Urea containing fertilizers when row banded with or near corn seed can result in uneven corn seedling emergence, stand loss, slow growth, and damaged roots as free ammonia is released during urea conversion to ammonium. Also, biuret in urea can cause misshapen plants or leaves that don't unroll.



Seed-placed urea stand loss and biuret damage





Potassium deficiency

## POTASSIUM (K)

Potassium deficiency yellows soybean leaves, beginning at the margins and moving inward over the leaf. Deficiency symptoms occur on older lower leaves first. All but the newest emerged leaves may show potassium deficiency symptoms in severe cases.



Iron deficiency

## IRON (Fe)

Iron deficiency of soybean is usually identified on young plants. Because iron is immobile in the plant, the deficiency symptoms occur on the youngest upper leaves. The leaves turn yellow, but the veins remain green. Iron deficiency occurs on high pH soils and frequently occurs on the calcareous soils of central and north central Iowa.

## MOLYBDENUM (Mo)

Molybdenum deficiency results in light green soybean plants. This indicates nitrogen deficiency because molybdenum is essential for the symbiotic nitrogen-fixation process. Molybdenum deficiency of soybean only occurs on very acid, highly weathered soils and has not been seen in Iowa.



Molybdenum deficiency





Broadcast nitrogen solution

## NON-PRESSURE NITROGEN SOLUTIONS (UREA-AMMONIUM NITRATE SOLUTION, 28 OR 32% UAN)

Non-pressure nitrogen solutions broadcast on top of growing soybean can burn leaf tissue. Application even at low rates can cause tissue damage. Soybean plants usually outgrow the damage if only a portion of the leaves is injured.

# NUTRIENT DEFICIENCIES

# ALFALFA



Potassium deficiency

## POTASSIUM (K)

Potassium deficiency creates small dots on the margins of the upper leaflets of alfalfa. When severely deficient, the size and number of spots increase, the leaves become yellow and dry, and the lower leaves drop.



Molybdenum deficiency

## MOLYBDENUM (Mo)

Molybdenum deficiency reduces the growth of alfalfa. Deficient plants tend to be pale or light green because molybdenum is essential for the nitrogen-fixation process. Molybdenum deficiency in alfalfa usually occurs only on very acid soils. It has not been verified in Iowa.





## **BORON (B)**

Boron deficiency on alfalfa shortens the internodes near the plant top, resulting in a bunching or bushy appearance of the upper plant. The top (new) leaves turn yellow and may have a reddish purple-pink coloration on the leaflet margins. This causes the deficiency to be mistaken for leafhopper injury. Lower leaves remain green. Boron deficiency usually occurs when weather is dry and on soils that are low in organic matter.



Sulfur deficiency

## **SULFUR (S)**

Sulfur deficiency shows as a general yellowing of the alfalfa foliage. With severe deficiency plant growth is stunted, stems are spindly, stands appear thin, and the alfalfa is less competitive.



Boron deficiency





Phosphorus deficiency

## PHOSPHORUS (P)

Phosphorus deficiency results in reduced early plant growth and tiller development, which gives the impression of a thin stand. Plants remain green but older leaves have reddish-purplish leaf tips and margins. Newly emerging leaves do not show the coloration. Phosphorus-deficient plants are smaller and grow more slowly than do plants with adequate phosphorus.

## NITROGEN (N)

Nitrogen deficiency appears as a general pale yellowish-green plant with slow growth and reduced tiller development. If the deficiency persists, plants remain pale green, have reduced growth, and the stand appears thin.



Nitrogen deficiency

## POTASSIUM (K)

Potassium deficiency appears as a yellowing and necrosis of the leaf tip and margins, beginning on the lower leaves. If the deficiency persists, symptoms progress up the plant as potassium is mobile in the plant and translocates from old to young leaves.



Potassium deficiency



## DIAGNOSIS

## FIELDS

Diagnosing nutrient deficiency symptoms is most reliable when all factors other than the nutrient in question favor normal growth and when the symptoms occur on several plants in an area following a specific soil or management pattern. Comparison of plants in affected and non-affected field areas, as well as other information like soil tests and cultural practices, can help determine specific causative factors.



Zinc deficiency in corn



Iron deficiency in soybean

### SOIL CONDITION

Nutrient deficiency symptoms that occur in irregular patterns in a field are probably due to a soil condition.



Potassium deficiency, not chiseled (left), chiseled (right)



Nitrogen skip pattern in corn

### CULTURAL PRACTICES

Symptoms that occur in a regular geometrical pattern are most likely due to cultural practices.

## DIAGNOSIS

## PLANTS

Nutrient deficiency symptoms occur as yellowing of leaves, interveinal yellowing of leaves, shortened internodes, or abnormal coloration such as red, purple, or bronze leaves. These symptoms appear on different plant parts as a result of nutrient mobility in the plant.



Potassium deficiency in corn, lower leaves



Iron deficiency in soybean, upper leaves

### MOBILE NUTRIENT

Symptoms caused by nutrients mobile in the plant (on the left) occur on the lower, older leaves.

### IMMOBILE NUTRIENTS

Symptoms caused by nutrients immobile in the plant (on the right) occur on the upper, younger leaves.

Prepared by: John Sawyer, ISU Extension agronomist (soil fertility and nutrient management)  
Find more information and photos at: <http://www.agronext.iastate.edu/soilfertility/homepage.html>  
Find related publications on the ISU Extension Store at: [www.extension.iastate.edu/store](http://www.extension.iastate.edu/store).

...and justice for all

The U.S. Department of Agriculture (USDA) prohibits discrimination in all its programs and activities on the basis of race, color, national origin, gender, religion, age, disability, political beliefs, sexual orientation, and marital or family status. (Not all prohibited bases apply to all programs.) Many materials can be made available in alternative formats for ADA clients. To file a complaint of discrimination, write USDA, Office of Civil Rights, Room 326-W, Whitten Building, 14th and Independence Avenue, SW, Washington, DC 20250-9410 or call 202-720-5964.

Issued in furtherance of Cooperative Extension work, Acts of May 8 and June 30, 1914, in cooperation with the U.S. Department of Agriculture. Jack M. Payne, director, Cooperative Extension Service, Iowa State University of Science and Technology, Ames, Iowa.

# Sampling For Plant Analysis (A2289)

K.A. Kelling, S.M. Combs, and J.B. Peters

Sample collection is critical for plant analysis as plant nutrient composition varies with age, the portion of the plant sampled, and many other factors. Mistakes or carelessness in selecting, collecting, handling, preparing, or shipping plant tissue for analysis can result in unreliable data, which may lead to incorrect interpretations and recommendations. Standards, against which the sample is evaluated, have been selected to represent the plant part and time of sampling that best define the relationship between nutrient composition and plant growth. Deviation from the prescribed protocol severely limits this interpretations capability. It is, therefore, critical to follow a standard sampling procedure.

## When and How to Sample Plants

Table 1 (following page) outlines the proper stage of growth, plant part, and number of plants to sample for major agronomic and horticultural crops. Similar information is depicted in figures on the last page of this publication. If a crop is sampled at other times in the growing season, the analysis will be provided but may not be interpreted on the University of Wisconsin plant analysis report. However, when plant analysis is being used to confirm a suspected nutrient deficiency, the samples should be taken as early in the season as possible so that the deficiency can be corrected and minimize the potential yield loss. Plants showing abnormalities usually continue to accumulate nutrients even if growth is impaired by some limiting factor.

Samples should not be taken from plants that obviously have been stressed from causes other than nutrients. Do not take samples from plants that —

- Are dead or insect damaged;
- Are mechanically or chemically injured;
- Have been stressed by too much or too little moisture (i.e., flooding or drought);
- Have been stressed by abnormally high or abnormally low temperature.

## Sample Normal and Abnormal Areas

When a nutrient deficiency is suspected (even without visual symptoms), or there is a need to compare different areas in a field, it is recommended that similar plant parts be collected separately from both the affected plants and adjacent normal plants that are at the same stage of growth. In this way, a better evaluation can be made between the nutritional status of healthy and abnormal plants of the same variety grown under the same conditions.

## Plant Tissue Sample Preparation

After a plant sample has been collected, it should be prepared for shipment or delivery to the laboratory. Roots or foreign material attached to the sample should be removed and discarded. Plant tissue must then be dusted off to remove soil particles. DO NOT WASH tissue since soluble nutrients will be leached out of the sample.

If tissue is to be mailed, the sample should be air-dried above a heating vent or in the sun for one to two days to avoid mold formation during shipment. Place the plant sample in a paper bag in a large paper envelope for shipment. Do not pack the sample tightly into the mailing container or put samples in plastic or polyethylene bags as this will also promote mold development. Plant samples that are delivered to the laboratory do not need to be air-dried if they are delivered within one day after sampling. Samples to be delivered directly to the laboratory at a later date may be kept frozen or air-dried until they are delivered.



## Include Soil Sample

Soil test results for pH, organic matter, phosphorus, and potassium (routine test) can be useful for correlating with plant analysis results to pinpoint a nutrient problem. A composite soil sample, consisting of five or more cores, should be taken from the same area where the plant sample was collected. For row crops, avoid the fertilizer band by sampling from the middle of the row. Put the sample into a soil sample bag or other waterproof container and label the soil sample with the same field and sample number as that assigned to the tissue sample. Package corresponding plant and soil samples together, but make certain soil sample bags do not open in transit as spilled soil will contaminate plants. No additional fee is charged for routine soil analysis when submitting along with a plant sample. Special soil test requests for Ca, Mg, S, B, Mn, or Zn are assessed an extra fee. For further details on proper soil sampling procedures, refer to UWEX Publication A21, "Sampling Soils for Testing."

## What To Do With Samples

A "Plant Analysis Information Sheet" should be filled out for any samples submitted. Use a separate information sheet for each sample. Plant samples, corresponding soil samples, and accompanying information sheets can be obtained and turned in at your County Extension Office. Samples may also be sent or delivered to the laboratory directly. The University of Wisconsin laboratory that conducts the plant analysis program is the Soil and Plant Analysis Laboratory at Madison. The address and telephone number are:

UW Soil and Plant Analysis Laboratory  
5711 Mineral Point Road  
Madison, WI 53705  
608-262-4364

Some, but not all, private laboratories also analyze plant tissues; therefore, you should check with your laboratory on the specific services they provide before submitting the samples.

## What the Analysis Report Will Include

The report will show the concentration of N, P, K, Ca, Mg, S, Zn, Mn, B, Cu, Fe, Al, and Na in the plant sample. If a soil was submitted with the plant sample, soil analyses for pH, organic matter, P, K, and any special soil test results will also be reported. In addition, the analytical levels of nutrients in the plant and soil will be interpreted to reflect nutrient deficiencies, toxicities, or imbalances by the sufficiency range approach, and if calibration data are available, the nutrient ratio method. When warranted, fertilizer recommendations will be made based on the analytical results. Most commonly grown field vegetables and fruit crops will receive these interpretations and recommendations. For those plant materials where calibration data are not available, these analytical results will be provided without interpretation.

Table 1. Recommended sampling stage of growth, plant part, and sample size for diagnostic plant tissue analysis.

Crop	Stage of growth	Plant part to sample	# of plants to sample
<b>Field Corn -----</b>			
alfalfa	bud to first flower	top 6 inches	35
alfalfa, hay	harvest	whole plant	25
barley	prior to heading	newest fully developed leaf	50
bean, dry	prior to or at initial flower	newest fully developed leaf	25

<b>Crop</b>	<b>Stage of growth</b>	<b>Plant part to sample</b>	<b># of plants to sample</b>
bean, lima	prior to or at initial flower	newest fully developed leaf	25
bean, snap	prior to or at initial flower	newest fully developed leaf	25
bluegrass	prior to heading	newest fully developed leaf	50
bromegrass	prior to heading	newest fully developed leaf	50
buckwheat	boot stage	whole plant	20
canary grass	prior to heading	newest fully developed leaf	50
canola	flowering	mature upper leaves	25
corn, field	12 inches tall	whole plant	20
corn	pre-tassel	leaf below whorl	15
corn	tassel to silk	ear leaf	15
corn, silage	ensiled or chopped	whole plant	2 qt
corn, sweet	tassel to silk	ear leaf	15
corn, pop	tassel to silk	ear leaf	15
fescue, fine	new summer growth	clippings	50
lupine	early flower	whole plant	25
millet	4 weeks after clipping	whole plant	25
mint	flowering	whole plant	25
oat	prior to heading	whole plant	50
orchard grass	prior to heading	newest fully developed leaf	50
pea, canning	prior to or at initial flower	newest fully developed leaf	25
pea, chick, field	prior to or at initial flower	newest fully developed leaf	25
potato	prior to or at initial flower	4th petiole & leaflet (whole lvs)	40
potato	tuber bulking	4th petiole & leaflet (whole lvs)	40
potato	prior to or at initial flower	4th petiole from top	50
potato	tuber bulking	4th petiole from top	50
red clover	bud to first flower	top 6 inches	35
red cover hay	harvest	whole plant	25
rice, wild	prior to heading	newest fully developed leaf	50
rye	prior to heading	newest fully developed leaf	50
sorghum, grain	prior to heading	2nd fully developed leaf	20
sorghum-sudan	prior to heading	newest fully developed leaf	50
soybean	prior to or at initial flower	newest fully developed leaf	25

<b>Crop</b>	<b>Stage of growth</b>	<b>Plant part to sample</b>	<b># of plants to sample</b>
sugar beet	prior to or at initial flower	newest fully developed leaf	25
sunflower	florets about to emerge	newest fully developed leaf	20
tobacco	45 to 60 days after planting	newest fully developed leaf	15
tobacco	early flower	newest fully developed leaf	15
tobacco	mature	leaves	15
trefoil, birdsfoot	bud to first flower	top 6 inches	35
triticale	prior to heading	newest fully developed leaf	50
vetch, crown	bud to first flower	top 6 inches	35
wheat	tillering	newest fully developed leaf	50
wheat	prior to heading	newest fully developed leaf	50
<b>Vegetable Crops -----</b>			
asparagus	mature fern	fern 17 to 35 inches up	20
beet, red	mid-season	youngest mature leaves	20
broccoli	heading	youngest mature leaves	20
brussels sprouts	heading	youngest mature leaves	20
cabbage	mid-season	wrapper leaves	20
carrot	mid-season	youngest mature leaves	20
cauliflower	mid-season	youngest mature leaves	20
celery	mid-season	youngest mature leaves	20
cucumber	prior to or at early fruit development	youngest mature leaves	20
ginseng	mid-season	youngest mature leaves	35
lettuce	mid-season	wrapper leaves	20
melon	prior to or at early fruit development	newest fully developed leaf	25
muskmelon	prior to or at early fruit development	newest fully developed leaf	25
onion	mid-season	tops, no white portion	20
pepper	prior to or at early fruit development	petiole and leaflet	40
pumpkin	prior to or at early fruit development	newest fully developed leaf	25
spinach	mid-season	newest fully developed leaf	25

<b>Crop</b>	<b>Stage of growth</b>	<b>Plant part to sample</b>	<b># of plants to sample</b>
squash	prior to or at early fruit development	newest fully developed leaf	25
tomato	mid-season	newest fully developed leaf	40
watermelon	prior to or at early fruit development	newest fully developed leaf	25
<b>Fruit Crops -----</b>			
apple	current season's shoots (1-15 July)	fully developed leaf at midpoint of new shoots	4 lvs
blueberry	new summer growth	fully developed leaves	35
cherry, sour	current season's shoots (1-15 July)	fully developed leaf at midpoint of new shoots	4 lvs
cranberry	15 Aug to 15 Sept	current season growth above berries	200 uprights
grape	full bloom	newest fully developed petiole	5 from each of 10 vines
raspberry	10 Aug to 4 Sept	6th and 12th leaf blade and petiole from tip	2-3 lvs from 10 canes
strawberry	at renovation before mowing	fully developed leaflets and petioles	40



# Wisconsin's Nutrient Management Standard 590

## - Summary -

September 2005 Revision

### Criteria for All Sites

#### 1. General Cases

- A. Annual field-specific nutrient application plan consistent with UWEX soil fertility recs. (A2809).
- B. Plan shall be based on realistic yield goals – no higher than 15% above the previous 3-5 year average.
- C. Routine soil testing shall be conducted at least once every four years.
  - 1) Sample soils according to UWEX recs (A2100).
  - 2) Analysis by a WDATCP-certified lab.
- D. Annual phosphorus (P) and potassium (K) recommendations may be combined into a single application to meet the total nutrient needs over the crop rotation.
  - 1) Combined annual application not allowed on frozen or snow-covered ground.
  - 2) Commercial P fertilizer shall not be applied to fields with soil test P in the excessively high (non-responsive) range.
    - Exception of up to 20 lb/a of P<sub>2</sub>O<sub>5</sub> starter for corn.
  - 3) Credit all P and K starter fertilizer against crop needs.
- E. Soil pH should be adjusted to optimum ranges.
- F. Nitrogen (N) applications shall not exceed annual crop need (or uptake).
  - 1) Exception: If legumes, manures, and/or organic byproducts are the only sources of N, N rate may exceed crop need by 20%.
  - 2) Credit any starter N fertilizer in excess of 20 lbs/a.
- G. First- and second-year legume-N credits shall be accounted and utilized.
- H. First-year available manure nutrient credits shall be accounted and utilized using either:
  - 1) Laboratory manure-nutrient analysis.
  - 2) UW estimates of first-year available nutrient content of manure.
- I. Other organic byproducts applied to fields need to be analyzed for nutrient content and applied according to existing regulations.
- J. Nutrients shall not run off fields during or immediately after application.
- K. Nutrient applications based on plant tissue analysis shall be done in accordance with UW sampling, testing, and interpretation guidelines.
- L. Where gleaming/pasturing occurs, do not allow the N and P manure additions to exceed the requirements of this standard.

#### 2. Nutrient Application Prohibitions

- A. Nutrients shall not be spread on:
  - 1) Surface water, concentrated flow channels, vegetative buffers, non-farmed wetlands, sinkholes, gravel/sand pits, wells.
  - 2) Non-cropland and/or non-pastured land.
    - Exception: Establishment and maintenance nutrient requirements are allowed.
  - 3) Areas within 50 feet of a well - - applies to manure only.
  - 4) Areas contributing runoff 200 feet upslope of direct conduits to groundwater (wells, sinkholes, surface fractured bedrock, tile inlets, or gravel/sand mines) unless nutrients are incorporated within 3 days.
  - 5) Fields exceeding tolerable soil loss (T).
- B. Frozen or snow-covered soil nutrient application prohibitions:
  - 1) 1,000 feet of a lake, pond, flowage or within 300 feet of a river/perennial stream (SWQMAs),
  - 2) Areas identified as direct conduits to groundwater or surface water,
  - 3) P removal of the following growing season's crop is not to be exceeded when applying manure. Liquid manure applications limited to 7,000 gallons/acre,
  - 4) Slopes greater than 9%.
    - Exception: Up to 12% for manure applications on contoured or contour stripped fields.
  - 5) No commercial N or P fertilizer.
    - Exception: Grass pastures and winter grains not contained in above prohibition areas.

#### 3. Nutrient Application Restrictions

- A. Application rates for unincorporated liquid manure on non-frozen soils within a SWQMA are not to exceed Table 1 values.
  - 1) No applications allowed on saturated soils.
  - 2) Subsequent manure applications possible (as standard allows) after 7 days or after soil evaluation (Table 1).
- B. All nutrient applications on non-frozen soil within a SWQMA shall be in conjunction with one or more of the following practices:
  - 1) Permanent vegetative buffers,
  - 2) Greater than 30% crop residue or vegetative cover after nutrient application,
  - 3) Incorporation within 3 days of application leaving adequate residue to meet "T",
  - 4) Cover crops established promptly following application.

## Criteria for Groundwater Protection

Applies to high permeability soils (sands, etc.), soils with less than 20 inches to bedrock, or soils with less than 12 inches to apparent water table. Also fields within 1,000 feet of a municipal well

### 1. N Application Restrictions:

- A. No fall applications of commercial N.
  - **Exception:** Establishment of fall-seeded crops - 30 lb N/acre maximum.
- B. Apply one of the following practices on irrigated fields, includes irrigated manure:
  - 1) Apply majority of N after crop establishment (sidedress or split), *or*
  - 2) Utilize a nitrification inhibitor with ammonium forms of N.

### 2. Manure-N Application Restrictions:

- A. When manure is applied in late summer/fall when soil temperatures are greater than 50° F, meet one of the following:
  - 1) Use a nitrification inhibitor with liquid manure and limit rate to 120 lbs N/acre,
  - 2) Apply after Sept. 15 and limit rate to 90 lbs N/acre,
  - 3) Apply to perennial or fall-seeded crops and limit rate to 120 lbs N/acre *or* the crop's N requirement – whichever is less.
- B. When manure is applied in fall and soil temperatures are 50° F or lower, limit rate to 120 lbs N/acre *or* the crop's N requirement – whichever is less.

### 3. P Leaching Restrictions:

- A. Where P additions to groundwater are identified, implement practices to reduce P delivery.

## Criteria for Surface Water Protection

### 1. Where manure, fertilizers, or organic byproducts are applied:

- A. Avoid building soil test P values beyond the excessively high range for the most demanding crop in the rotation (30 to 50 ppm for most agronomic crops).
- B. Establish perennial vegetative cover in all areas of concentrated flow where gullies occur.

### 2. Develop a plan for managing P when manure or organic byproducts are applied using one of the following strategies. Selected strategy must be applied uniformly to all fields within a farm or tract.

- A. Phosphorus Index (PI) Strategy:
  - 1) The PI assesses P delivery to surface waters from fields. See <http://wpindex.soils.wisc.edu>,
  - 2) The planned PI value for up to an 8-year rotation of each field shall be 6 or lower.
  - 3) P applications on fields with a PI > 6 are allowed only if needed according to UWEX soil fertility recs.

### B. Soil Test P Strategy:

- 1) P applications from all sources must be based on the following soil test P values:
  - a) < 50 ppm P - Nutrient applications allowed up to crop N need/removal,
  - b) 50 – 100 ppm P - Applications of P shall not exceed crop removal of P over a rotation (8 year max),
  - c) > 100 ppm P - Eliminate P applications, unless required by highest P-demanding crop in the rotation.
    - **Exception:** If P (i.e. manure-P) must be applied, applications shall be 25% less than the **cumulative** annual crop P removal over the rotation (8 year max).
    - **Exception:** For potatoes, P applications shall not exceed rotational crop removal (8 year max) if soil tests are optimum, high, or excessively high for potatoes.

## Criteria for Air Quality Protection

Where air quality is identified as a concern, a management plan that minimizes N volatilization and particulate emissions while maintaining "T" shall be applied.

## Criteria for Soil Quality Protection

1. Nutrients shall be applied in a manner that does not permanently degrade the soil's physical, chemical, or biological conditions.
2. To the extent practical, nutrients shall not be applied to flooded or saturated soils when the potential for soil compaction is high.

**Table 1. Maximum unincorporated liquid manure application rate within a SWQMA.**

Soil Texture Class <sup>1</sup>	Maximum Application Rate		Allowable Soil Moisture Description for Applications
	< 30% <sup>2</sup>	> 30% <sup>2</sup>	
	----- gal/acre -----		
Fine	3,000	5,000	Easily ribbons out between fingers, slick feel.
Medium	5,000	7,500	Forms a ball, very pliable, slicks readily with clay.
Coarse	7,000	10,000	Forms a weak ball, breaks easily.

<sup>1</sup> Fine – clay, silty clay, silty clay loam, clay loam; Medium – sandy clay, sandy clay loam, loam, silt loam, silt; Coarse – loamy sand, sandy loam, sand. The coarse category also includes peat and muck.

<sup>2</sup> Crop residue or vegetative cover on the soil surface after manure application.

# NUTRIENT MANAGEMENT

(Acre)  
Code 590

Natural Resources Conservation Service  
Conservation Practice Standard

## I. Definition

Managing the amount, source, placement, form, and timing of the application of nutrients and soil amendments.

## II. Purposes

This standard establishes the acceptable criteria and documentation requirements for a plan that addresses the application and *budgeting*<sup>1</sup> of nutrients for plant production. All nutrient sources, including soil reserves, commercial fertilizer, manure, organic byproducts, legume crops, and crop residues shall be accounted for and properly utilized. These criteria are intended to minimize nutrient entry into surface water, groundwater, and atmospheric resources while maintaining and improving the physical, chemical, and biological condition of the soil.

## III. Conditions Where Practice Applies

This standard applies to all *fields* where plant nutrient sources and soil amendments are applied during the course of a *rotation*.

## IV. Federal, State, and Local Laws

Users of this standard are responsible for compliance with applicable federal, state, and local laws, rules, or regulations governing nutrient management systems. This standard does not contain the text of federal, state, or local laws. Implementation of this standard may not eliminate nutrient losses that could result in a violation of law.

## V. Criteria

This section establishes requirements for planning, design parameters, acceptable management processes, and performance requirements for nutrient management plan development and implementation. Nutrient management plans shall be prepared according to all of Criteria A., B., C., D., and E.

All of the information contained in this section is required. Wisconsin Conservation Planning Technical Note WI-1 is the companion document to this standard and includes criteria that are required where referenced within this section.

## A. Criteria for Surface and Groundwater Resources

### 1. Nutrient Criteria for All Sites

- a. Develop and implement an annual field-specific nutrient application plan. Account for the source, rate, timing, form, and method of application for all *major nutrients* consistent with this standard and soil fertility recommendations found in University of Wisconsin-Extension (UWEX) Publication A2809, "Soil Test Recommendations for Field, Vegetable and Fruit Crops," unless use of one the following options are appropriate:
  - For crops not listed in A2809, use other appropriate Land Grant University recommendations.
  - For nutrient application decisions based on plant tissue analysis, the sampling and testing of plants and the resulting nutrient recommendations shall be done in accordance with University of Wisconsin recommendations. See V.A.1.1.

Annual plan updates shall document the crops, tillage, nutrient application rates, and methods actually implemented.

- b. The plan shall be based on yield goals that are attainable under average growing conditions and established

<sup>1</sup> Words in the standard that are shown in italics are described in X. Definitions. The words are italicized the first time they are used in the text.

- using soil productivity, local climate information, multi-year *documented yields*, and/or local research on yields for similar soils and crop management systems. Yield goals should not be higher than 15% above the previous 3-5 year average.
- c. Soils shall be tested a minimum of once every four years by a DATCP-certified laboratory for pH, phosphorus (P), potassium (K), and organic matter. A laboratory list is provided in Appendix 2 of the Wisconsin Conservation Planning Technical Note WI-1. Soil sampling shall be consistent with UWEX Publication A2100, "Sampling Soils for Testing." For perennial fruit crops, use of soil test recommendations from UWEX Publication A-2809 is only required as the basis for fertilizer applications prior to establishment of new plantings. Subsequent nutrient recommendations should be based on plant tissue analysis results. See V.A.1.I.
  - d. Annual P and K nutrient recommendations may be combined into a single application that does not exceed the total nutrient recommendation for the rotation. This combined annual application is not allowed on frozen or snow covered soil. Commercial P fertilizers shall not be applied to soils with P tests in the non-responsive range for the crop being grown with the exception of not more than 20 pounds per acre P<sub>2</sub>O<sub>5</sub> as starter for corn or recommended rates of starter P<sub>2</sub>O<sub>5</sub> for potatoes and other vegetable crops as identified in UWEX Publication A3422, "Commercial Vegetable Production in Wisconsin." All the P and K starter fertilizer shall be credited against crop needs. When grouping fields for nutrient application purposes, N, P, and K application rates shall match individual field recommendations as closely as possible.
  - e. Where practical, adjust soil pH to the specific range of the crop(s) grown to optimize nutrient utilization.
  - f. Available nitrogen from all sources shall not exceed the annual N requirement of non-legume crops consistent with UWEX Publication A2809, or the annual N uptake by legume crops. Because of variability in N mineralization and manure applications, it is acceptable for available N to be up to 20% more than the recommended N rate when legumes, manures, and organic byproducts are used to meet the entire N requirement of the crop to be grown.  
  
Starter N fertilizers are to be credited against crop needs as follows: all N beyond 20 pounds per acres for corn and 40 pounds per acre for potatoes.
  - g. First year available N in manure applied to fields prior to legume crop establishment shall not exceed the first year's annual N removal by legumes and companion crop. See Wisconsin Conservation Planning Technical Note WI-1, Part II B.4.
  - h. First and second-year legume credits shall be applied as identified in UWEX Publication A2809, Table 25, or through soil nitrate testing as identified in UWEX Publication A3624, "Soil Nitrate Tests for Wisconsin Cropping Systems."
  - i. Estimates of first-year available nutrient credits for manure shall be established in accordance with one of the following methods:
    - (1) A manure analysis from a laboratory participating in the Manure Analysis Proficiency (MAP) testing program and interpreted according to Part III, Table 3 of the Wisconsin Conservation Planning Technical Note WI-1, or
    - (2) Estimates of first-year available nutrients from manure. See Part III, Table 4 of the Wisconsin Conservation Planning Technical Note WI-1.
- Note:** It is strongly recommended that second-year nutrient credits, especially for areas receiving consecutive manure applications, be



- included in the nutrient management plan using values in Part III, Table 4 of Wisconsin Conservation Planning Technical Note WI-1 or soil nitrate testing.
- j. Organic byproducts other than manure (i.e., industrial wastes, municipal sludge, and septage) applied to fields shall be analyzed for nutrient content and applied in accordance with applicable regulations including restrictions on heavy metal content and land application rates.
  - k. Manures, organic byproducts, and fertilizers shall not run off the field site during or immediately after application. If ponding, runoff, or drainage to subsurface tiles of the applied materials occurs, implement the following activities as appropriate:
    - (1) Stop application.
    - (2) Take corrective action to prevent offsite movement.
    - (3) Modify the application (rate, method, depth of injection, timing) to eliminate runoff or drainage to subsurface tiles.
    - (4) Notify the Wisconsin Department of Natural Resources (WDNR) in the event that a spill or accidental release of any material or substance when required by the Agricultural Spill Law (s.289.11, Wis. Stats.) or the terms of a WPDES permit. Refer to the Wisconsin Conservation Planning Technical Note WI-1, Part IV, for contact information and "Agricultural Spills and How to Handle Them," Pub-RR-687-2002, August 2002.
  - l. Where nutrient application decisions are based on plant tissue analysis, the sampling and testing of plants and the resulting nutrient recommendations shall be done in accordance with University of Wisconsin recommendations in the references section of this standard. Nutrient recommendations for cranberries may be based on plant analysis as defined by appropriate publications in the references section of this standard.
  - m. Where *gleaning/pasturing* occurs, verify through computations that the nutrients deposited as manure within a field, do not exceed the N and P requirements of this standard.
2. Nutrient Application Prohibitions
- a. Nutrients shall not be spread on the following features.
    - (1) Surface water, established *concentrated flow channels*, or non-harvested *permanent vegetative buffers*.
    - (2) A non-farmed wetland, sinkhole, nonmetallic mine, or well.
    - (3) The area within 50 feet of a potable drinking water well shall not receive mechanical applications of manure.
    - (4) Areas contributing runoff within 200 feet upslope of *direct conduits to groundwater* such as a well, sinkhole, fractured bedrock at the surface, *tile inlet*, or nonmetallic mine unless the nutrients are *effectively incorporated* within 72 hours.
    - (5) Land where vegetation is not removed mechanically or by grazing, except to provide nutrients for establishment and maintenance, unless necessary in an emergency situation.
    - (6) Fields exceeding *tolerable soil loss (T)*. Erosion controls shall be implemented so that tolerable soil loss (T) over the crop rotation will not be exceeded on fields that receive nutrients.
  - b. When frozen or snow-covered soils prevent effective incorporation at the time of application and the nutrient application is allowed, implement the following:
    - (1) Do not apply nutrients within the *Surface Water Quality Management Area (SWQMA)*

- except for manure deposited through winter gleaning/pasturing of plant residue.
- (2) Do not apply nutrients to locally identified areas delineated in a *conservation plan* as contributing nutrients to direct conduits to groundwater or surface water as a result of runoff.
- (3) Do not exceed the P removal of the following growing season's crop when applying manure. Liquid manure applications are limited to 7,000 gallons per acre. The balance of the crop nutrient requirement may be applied the following spring or summer. Winter applications shall be conducted according to Section VII.B.
- (4) Do not apply nutrients on slopes greater than 9%, except for manure on slopes up to 12% where cropland is contoured or contour strip cropped.
- (5) Do not apply N and P in the form of commercial fertilizer. An exception is allowed for grass pastures and on winter grains that do not fall within a prohibition area defined by V.A.2.
3. Nutrient Application Restrictions
- a. When unincorporated liquid manure applications (less than 12% solids) occur on non-frozen soils within a SWQMA, use Table 1 to determine maximum acceptable rates. No applications are allowed on *saturated soils*.
- Sequential applications may be made to meet the desired nutrient additions consistent with this standard. Prior to subsequent applications soils shall be evaluated using Table 1 or wait a minimum of 7 days.

**Table 1.**

Surface Texture Class <sup>1</sup>	Max Application Rate <i>gal/acre</i>		Allowable Soil Moisture Description for Applications
	< 30%*	≥ 30%*	
Fine	3000	5000	Easily ribbons out between fingers, has a slick feel.
Medium	5000	7500	Forms a ball, is very pliable, slicks readily with clay.
Coarse	7000	10000	Forms a weak ball, breaks easily.

<sup>1</sup> Fine – clay, silty clay, silty clay loam, clay loam

Medium – sandy clay, sandy clay loam, loam, silt loam, silt

Coarse – loamy sand, sandy loam, sand. This category also includes peat and muck based on their infiltration capacity.

\* Crop residue or vegetative cover on the soil surface after manure application.

- b. For all nutrient applications on non-frozen soil within a SWQMA use one or more of the following practices as appropriate to address water quality concerns for the site:
  - (1) Install/maintain permanent vegetative buffers (harvesting is allowed unless restricted by other laws or programs). Refer to NRCS Field Office Technical Guide (FOTG), Section IV, Standard 393, Filter Strip, or ATCP 48 for land in drainage districts.
  - (2) Maintain greater than 30% crop residue or vegetative cover on the soil surface after nutrient application.
  - (3) Incorporate nutrients within 72 hours leaving adequate residue to meet tolerable soil losses.
  - (4) Establish cover crops promptly following application.
- 2. When manure is applied in late summer or fall to meet the fertility needs of next year's crop and soil temperatures are greater than 50°F, apply one of the following options:
  - a. Use a nitrification inhibitor with liquid manure and limit N rate to 120 pounds available N per acre.
  - b. Delay applications until after September 15 and limit available N rate to 90 pounds per acre.
  - c. Apply to fields with perennial crops or fall-seeded crops. N application shall not exceed 120 pounds available N per acre or the crop N requirement, whichever is less.
- 3. When manure is applied in the fall and soil temperatures are 50°F or less, limit available N from manure application to 120 pounds per acre or the crop N requirement, whichever is less.

**Note:** The restrictions in B. 2. and 3. do not apply to spring manure applications prior to planting. The balance of the crop N requirements may be applied the following spring or summer.

- 4. Where P enrichment of groundwater is identified as a conservation planning concern, implement practices to reduce delivery of P to groundwater.

#### B. Criteria to Minimize Entry of Nutrients to Groundwater

To minimize N leaching to groundwater on *high permeability soils*, or soils with less than 20 inches to bedrock, or soils with less than 12 inches to *apparent water table*, or within 1000 feet of a municipal well, apply the following applicable management practices:

**Note:** A list of soils with a high potential for N leaching to groundwater is provided in Appendix 1 of the Wisconsin Conservation Planning Technical Note WI-1.

- 1. Where sources of N are applied:
  - a. No fall commercial N applications except for establishment of fall-seeded crops. Commercial N application rates, where allowed, shall not exceed 30 pounds of available N per acre.
  - b. On irrigated fields, including irrigated manure, apply one of the following management strategies:
    - (1) A split or delayed N application to apply a majority of crop N requirement after crop establishment.
    - (2) Utilize a nitrification inhibitor with ammonium forms of N.

#### C. Additional Criteria to Minimize Entry of Nutrients to Surface Water

- 1. Where manure, organic byproducts, or fertilizers are applied:
  - a. Avoid building soil test P values when possible beyond the non-responsive soil test range for the most demanding crop in the rotation. For most agronomic crops in Wisconsin, the non-responsive soil test range is 30 to 50 parts per million (ppm) Bray P-1 soil test.
  - b. Establish perennial vegetative cover in all areas of concentrated flow resulting in reoccurring gullies.
- 2. Develop a P management strategy when manure or organic by-products are applied during the crop rotation to minimize surface

water quality impacts. Use either the *Phosphorus Index (PI)* in section a., or Soil Test Phosphorus Management Strategy found in section b. The single strategy chosen, either a. or b., shall be applied uniformly to all fields within a farm or tract.

**Note:** First year available N in manure applied to fields prior to legume crop establishment shall not exceed the first year's annual N removal by legumes and companion crop. See Wisconsin Conservation Planning Technical Note WI-1, Part II B.4. Available N applied cannot exceed the N need or legume crop N removal of the next crop to be grown.

- a. PI Strategy – The planned average PI values for up to an 8-year rotation in each field shall be 6 or lower. P applications on fields with an average PI greater than 6 may be made only if additional P is needed according to UWEX soil fertility recommendations. Strategies for reducing the PI, algorithms, and software for calculating the Wisconsin PI can be found at <http://wpindex.soils.wisc.edu/>.
- b. Soil Test Phosphorus Strategy - Management strategies based on soil test phosphorus may be used. Operations using this strategy shall have a conservation plan addressing all soil erosion consistent with the current crops and management or use the erosion assessment tools included with the Phosphorus Index model. In crop fields where ephemeral erosion is an identified problem, a minimum of one of the following runoff-reducing practices shall be implemented:
  - Install/maintain contour strips and/or contour buffer strips. Refer to NRCS FOTG, Section IV, Standard 585, Strip Cropping, and/or Standard 332, Contour Buffer Strip.
  - Install/maintain filter strips (NRCS FOTG, Section IV, Standard 393, Filter Strip) along surface waters and concentrated flow channels that empty into surface waters that are within or adjoin areas where manure will be applied.

- Maintain greater than 30% crop residue or vegetative cover on the soil surface after planting.
- Establish fall cover crops.

Available phosphorus applications from all sources shall be based on the following soil test P values (Bray P-1).

- (1) Less than 50 ppm soil test P: nutrient application rates allowed up to the N needs of the following crop or the N removal for the following legume crop.
- (2) 50-100 ppm soil test P: P application shall not exceed the total crop P removal for crops to be grown over a maximum rotation length of 8 years.
- (3) Greater than 100 ppm soil test P: eliminate P applications, if possible, unless required by the highest P demanding crop in the rotation. If applications are necessary, applications shall be 25% less than the cumulative annual crop removal over a maximum rotation length of 8 years.
- (4) For land with potatoes in the rotation, total P applications shall not exceed crop removal over a maximum rotation length of 8 years if soil tests are in the optimum, high, or excessively high range for potatoes.

#### **D. Additional Criteria to Minimize N and Particulate Air Emissions**

Where air quality is identified in a conservation plan as a resource concern, apply a management strategy that minimizes nutrient volatilization and particulate losses while maintaining tolerable soil erosion levels for wind and water.

#### **E. Additional Criteria to Protect the Physical, Chemical, and Biological Condition of the Soil**

1. Nutrients shall be applied in such a manner as not to permanently degrade the soil's structure, chemical properties, or biological condition.



2. To the extent practical, nutrients shall not be applied to flooded or saturated soil when the potential for soil compaction and/or the creation of ruts is high.

## VI. Considerations

The following are optional management considerations and are not required practices.

- A. Promote seeding and stabilization of concentrated flow channels, installation and maintenance of vegetative filter strips, riparian buffers and other buffer strips adjacent to surface water and wetlands in conjunction with other conservation practices in order to reduce the amounts of sediment and nutrients that reach surface water and/or groundwater.
- B. Corn nitrogen recommendations in A2809 can be adjusted for the effects of current corn and nitrogen fertilizer prices using the N rate calculator available at <http://www.uwex.edu/ces/crops/NComparison.htm>. Additional management practices that can be utilized to improve N use efficiency can be found in the Wisconsin Conservation Planning Technical Note WI-1, Part II.
- C. Apply nutrients not specifically addressed by this standard (i.e., secondary and micro nutrients) based on recommendations found in UWEX Publication A2809.  
  
Since specific environmental concerns have not been identified for potassium (K), K additions in manure or bio-solids will be determined by rate limits for the N or P in those materials. Commercial fertilizer K applications equal to crop removal will avoid building soil test K levels. K may be applied equal to crop removal at any soil test K level. Dairy producers should monitor K levels in forages and take additional steps to reduce soil K levels if consumption of forage with high K levels becomes an animal health problem.
- D. To minimize N leaching on medium and fine-textured soils, avoid fall commercial N applications for crops to be seeded the following spring. When commercial N is applied in the fall, use ammonium forms of N and delay N application until soil temperatures drop below 50°F. Use of a nitrification inhibitor with fall-applied N is recommended.
- E. Irrigated fields should use irrigation scheduling strategies with the intent of minimizing leaching

losses and improving water use efficiency and not exceeding intake/infiltration capacity of the soil.

- F. Consider the use of animal feeding strategies based on published nutrition research findings (National Research Council, etc.) to reduce excess P in rations when manure applications are made to cropland.
- G. Consider delaying surface applications of manure or other organic byproducts if precipitation capable of producing runoff is forecast within 24 hours of the time of planned application.
- H. Consider modifications to the crop rotation to provide crop fields for the application of manure during the summer crop growing season.
- I. Manure top-dressed on existing forages should not exceed the nutrient equivalent of 35 pounds N – 25 pounds P<sub>2</sub>O<sub>5</sub> – 80 pounds K<sub>2</sub>O (first year availability per acre) or no more than 10 tons of solid manure per acre per harvest. Additional management considerations can be found in “Applying Manure to Alfalfa,” North Central Regional Research Report 346.
- J. For fields directly adjacent to, or with areas of concentrated or channelized flow that drain directly to, Outstanding, Exceptional or nutrient impaired surface waters, avoid raising soil test P levels to the maximum extent practicable. In addition, implement conservation practices that reduce delivery of nutrients to these waters. For operations using the P-Index in high environmental risk areas, the P-Index values should be reduced to the maximum extent practicable by applying additional conservation practices.
- K. Where residual nitrate carryover is probable, the preplant soil nitrate test is recommended to adjust N application rates.

## VII. Plans and Specifications

- A. The minimum requirements for a nutrient management plan are specified in the previous sections of this standard and expanded in Part I of the Wisconsin Conservation Planning Technical Note WI-1. Include in a nutrient management plan:
  - a soil map and aerial photograph of the site;

- current and planned crops and crop yields; realistic yield goals;
  - results of soil, plant, manure, or organic byproduct sample analysis;
  - recommended nutrient application rates;
  - documentation of actual nutrient applications including the rate, form, timing, and method. Revise the plan to reflect any changes in crops, yields, tillage, management, and soil or manure analyses;
  - the location of sensitive areas and the resulting nutrient application restrictions;
  - guidance for implementation, maintaining records;
  - each field's tolerable and actual soil losses;
  - soil test P-ppm; P balance, or P Index level where applicable;
  - other management activities required by regulation, program requirements, or producer goals;
  - a narrative to explain other implementation clarifications.
- B. Winter Spreading Plan – The plan shall identify those areas of fields that meet the restrictions for frozen or snow-covered ground identified in this standard. If necessary, land application of manure on frozen and snow-covered ground shall occur on those fields accessible at the time of application that represent the lowest risk of runoff and deliverability to areas of concentrated and channelized flow and surface waters. Low-risk fields shall be identified using either the P-Index or an approved conservation plan. In general, fields most suitable for land application during frozen and snow-covered ground conditions include those fields:
- with low slope,
  - with low erosion,
  - with high levels of surface roughness,
  - with the greatest distance to surface waters and areas of concentrated flow,
  - with no drainage to Outstanding/ Exceptional/nutrient impaired water bodies,
  - with low delivery potential during active snowmelt.

Refer to section VIII.E for storage/infield stacking of manure during periods of active snowmelt.

- C. Persons who review or approve plans for nutrient management shall be certified through any

certification program acceptable to the NRCS (NRCS General Manual, Title 180, Part 409.9, NRCS TechReg) or other appropriate agencies within the state.

- D. Industrial wastes and byproducts and municipal sludge are regulated by the Wisconsin Department of Natural Resources (WDNR). They must be spread in accordance with a Wisconsin Pollution Discharge Elimination System (WPDES) permit as obtained from the WDNR.
- E. Plans for nutrient management shall be developed in accordance with policy requirements of the NRCS General Manual Title 450 Part 401.03 and Title 190, Part 402, the contents of this standard, the procedures contained in the National Planning Procedures Handbook, and NRCS National Agronomy Manual, Section 503.
- F. Plans for Nutrient Management that are elements of a more comprehensive conservation plan shall recognize other requirements of the conservation plan and be compatible with the other requirements. A Comprehensive Nutrient Management Plan (CNMP) is a conservation system unique to animal feeding operations (AFO). The CNMP will be developed to address the environmental risks identified during the resource inventory of an AFO. A CNMP will require use of all the applicable criteria in this technical standard along with the additional criteria located in NRCS National Planning Procedures Handbook, Subpart B, Part 600.54.

## VIII. Operation and Maintenance

- A. Document the actual nutrient application including the rate, form, timing, and method of the application. Revise the plan to reflect any changes in crops, tillage or management, soils, and manure tests.
- B. Evaluate the need to modify field operations to reduce the risk of large nutrient losses during a single runoff event based on current field conditions or forecasted weather events.
- C. Minimize operator exposure to potentially toxic gases associated with manure, organic wastes, and chemical fertilizers, particularly in enclosed areas. Wear protective clothing appropriate to the material being handled.

- D. Protect commercial fertilizer from the weather, and agricultural waste storage facilities from accidental leakage or spillage. See Wisconsin administrative rules and county or local ordinances concerning regulations on siting, design, operation, and maintenance of these facilities.
- E. During periods when land application is not suitable, manure shall be stored in a manure storage facility designed in accordance with the criteria contained in NRCS FOTG Standard 313, Waste Storage Facility. Temporary management of manure shall be in accordance with the criteria for temporary unconfined stacks of manure contained in Table 7 of Standard 313.
- F. When cleaning equipment after nutrient application, remove and save fertilizers or wastes in an appropriate manner. If the application equipment system is flushed, use the rinse water in the following batch of nutrient mixture where possible or dispose of according to state and local regulations. Always avoid cleaning equipment near high runoff areas, ponds, lakes, streams, and other water bodies. Extreme care must be exercised to avoid contaminating potable drinking water wells.
- G. The application equipment shall be calibrated to achieve the desired application rate.

## IX. References

Cranberry Tissue Testing for Producing Beds in North America (1995) Davenport et al., Oregon State Univ. Ext. Serv. Pub. CM8610.

Mineral Nutrition for Fruit Crops, Roper, Univ. of Wisconsin Dept. of Horticulture Pub.

National Research Council (NRC) Nutrient Requirements of Dairy Cattle, National Academy Press, 7<sup>th</sup> Revised Edition, 2001.

Nitrogen for Bearing Cranberries in North America (2000) Davenport et al., Oregon State Univ. Ext. Pub.

North Central Regional Research Report 346, Applying Manure to Alfalfa, December 2003.

Phosphorus for Bearing Cranberries in North America (2004) Roper et al., Univ. of Wisconsin Ext. Pub.

TechReg Website: <http://techreg.usda.gov>

USDA, NRCS, General Manual, Title 180, Part 409 Conservation Planning Policy, Wisconsin Supplement 409.9, Minimum Criteria to Achieve an NRCS Certified Conservation Planner Designation.

USDA, NRCS, General Manual, Title 190, Part 402, Nutrient Management.

USDA, NRCS, National Agronomy Manual, October 2002.

USDA, NRCS, National Planning Procedures Handbook, Amendment 4, March 2003.

USDA, NRCS, National Handbook of Conservation Practices, Subpart B, Part 600.54, Element Criteria for CNMP Development.

USDA, NRCS, Wisconsin Conservation Planning Technical Note WI-1, Companion Document to NRCS FOTG Standard 590, Nutrient Management.

USDA, NRCS, Wisconsin Field Office Technical Guide (FOTG), Section I, Erosion Prediction, Maps.

USDA, NRCS, Wisconsin Field Office Technical Guide (FOTG), Section II, Soil Interpretations (T-Value).

USDA, NRCS, Wisconsin Field Office Technical Guide (FOTG), Section IV, Practice Standards and Specifications.

University of Wisconsin-Extension (UWEX) Publication A2100, Sampling Soils for Testing, May 2, 2001.

University of Wisconsin-Extension (UWEX) Publication A2809, Soil Test Recommendations for Field, Vegetable, and Fruit Crops, revised 1998.

University of Wisconsin-Extension (UWEX) Publication A3340, Corn Fertilization.

University of Wisconsin-Extension (UWEX) Publication A3392, Guidelines for Applying Manure to Cropland and Pasture in Wisconsin, August, 1995.

University of Wisconsin-Extension (UWEX) Publication A3422, Commercial Vegetable Production in Wisconsin, 2005.

University of Wisconsin-Extension (UWEX) Publication A3512, Wisconsin's Preplant Soil Profile Nitrate Test, 1990.

University of Wisconsin-Extension (UWEX) Publication A3517, Using Legumes as a Nitrogen Source, September 1997.

University of Wisconsin Extension (UWEX) Publication A3557, Nutrient Management: Practices for Wisconsin Corn Production, September 1994.

University of Wisconsin-Extension (UWEX) Publication A3568, A Step-by-Step Guide to Nutrient Management, May 1992.

University of Wisconsin-Extension (UWEX) Publication A3624, Soil Nitrate Tests for Wisconsin Cropping Systems, 1994.

University of Wisconsin-Extension (UWEX) Publication A3634, Nitrogen Management on Sandy Soils, 1995.

University of Wisconsin-Extension (UWEX), Nitrogen Source and \$ Rate of Return Calculator, Rankin, <http://www.uwex.edu/ces/crops/NComparison.htm>

University of Wisconsin-Extension (UWEX), NPM Program, Know How Much You Haul!, [ipcm.wisc.edu](http://ipcm.wisc.edu).

University of Wisconsin-Extension (UWEX) Publication A3769, Recommended Methods of Manure Analysis, 2003.

University of Wisconsin Soil and Forage Analysis Lab Sampling for plant analysis: <http://uwlab.dyndns.org/marshfield/> (Click on Lab procedures and then plant analysis).

Wisconsin Administrative Code, Department of Agriculture, Trade and Consumer Protection, Chapter 48, Drainage Districts.

Wisconsin Phosphorus Index: <http://wpindex.soils.wisc.edu/>.

## X. Definitions

*Apparent Water Table* (V.B) - Continuous saturated zone in the soil to a depth of at least 6 feet without an unsaturated zone below it.

*Budgeting* (II) - Document present and prior year's crop, estimated nutrient removal by these crops and known nutrient credits. When nutrients are applied for future crop needs in the rotation, implement a tracking process to allow adjustment of subsequent nutrient applications so that the total amount of nutrients applied to the farm or tract complies with this standard and is documented in the plan. Required as a component for all nutrient management plans (VII.A.; Wisconsin Conservation Planning Technical Note WI-1 Part 1 B.d. (1), (2); C.6.).

*Concentrated Flow Channel* (V.A.2.a.(1)) - A natural channel or constructed channel that has been shaped or graded to required dimensions and established in perennial vegetation for the stable conveyance of runoff. This definition may include non-vegetated channels caused by ephemeral erosion. These channels include

perennial and intermittent streams, drainage ditches, and drainage ends identified on the NRCS soil survey and not already classified as SWQMAs.

Concentrated flow channels are also identifiable as contiguous up-gradient deflections of contour lines on the USGS 1:24,000 scale topographic map. The path of flow to surface water or direct conduits to groundwater must be documented. For construction, refer to NRCS FOTG Standard 412, Grassed Waterway, for more information.

*Conservation Plan* (V.A.2.b.(2)) - A plan developed and field verified by a conservation planner to document crop management and the conservation practices used to control sheet and rill erosion to tolerable levels (T) and to provide treatment of ephemeral soil erosion. A conservation plan must be signed by the land operator and approved by the county land conservation committee or their representative. A conservation plan will be needed for designating winter spreading restrictions other than those specifically listed in this standard, and when implementing the soil test P management strategy where the soil erosion assessment is not calculated with the Wisconsin Phosphorus Index model. A conservation planner must develop conservation plans using the minimum criteria found in the USDA, NRCS National Planning Procedures Handbook and the Wisconsin Field Office Technical Guide and be qualified by one of the following:

1. Meeting the minimum criteria in the NRCS General Manual, Title 180, Part 409.9(c), NRCS Certified Conservation Planner Designation.
2. Meeting criteria established by the county land conservation committee.
3. Meeting the NRCS TechReg Certified Conservation Planner Option 1, 2, 3.

*Direct Conduits to Groundwater* (V.A.2.a.(4)) - Wells, sinkholes, swallets (a sinkhole or rock hole that intercepts a stream, diverting all or a portion of it to the groundwater), fractured bedrock at the surface, mine shafts, non-metallic mines, tile inlets discharging to groundwater quarries, or depressional groundwater recharge areas over shallow fractured bedrock. For the purpose of nutrient management planning, these features will be identified on the NRCS soil survey and/or USGS 1:24,000 scale topographic map, or otherwise determined through on-site evaluation and documented in a conservation plan.



*Documented yields* (V.A.1.b.) - Crop production yield-records documented by field for at least two consecutive years that are used to determine phosphorus and potassium fertility recommendations. Yield record documentation may include measurements of harvested crop weight, volume, or the use of calibrated yield-monitors.

*Effectively Incorporated* (V.A.2.a.(4)) - Means the mixing with the topsoil or residue or subsurface placement of nutrients with topsoil by such means as injector, disc, sweep, mold-board plow, chisel plow, or other tillage/infiltration methods. Nutrients will not run off the field or drain to subsurface tiles during application.

*Fields* (III) - A group or single nutrient management unit with the following conditions: similar soil type, similar cropping history, same place in rotation (i.e., second year corn fields, established alfalfa), similar nutrient requirements, and close proximity. Examples include: alternate strips in a contour strip system, pasture, variable rate nutrient application management units, and other management units where grouping facilitates implementation of the nutrient management plan.

*Gleaning / Pasturing* (V.A.1.m.) - An area of land where animals graze or otherwise seek feed in a manner that maintains the vegetative cover over all the area and where the vegetative cover is the primary food source for the animals. Livestock shall be managed to avoid the routine concentration of animals within the same area of the field. Manure deposited near a well by grazing of livestock does not require incorporation.

*High Permeability Soils* (V.B) - Equivalent to drained hydrologic group A that meet both of the following criteria:

1. Permeability = 6 inches/hour or more in all parts of the upper 20 inches and
2. Permeability = 0.6 inches/hour or more in all parts of the upper 40 inches.

Use the lowest permeability listed for each layer when evaluating a soil. For a multi-component map unit (complex), evaluate each component separately. If the high permeability components meet the criteria and cannot be separated, the entire map unit should be considered as high permeability.

*Major Nutrients* (V.A.1.a) - Nitrogen (N), phosphorus (P), and potassium (K).

*Note* (V.A.1.i.) - Any section labeled as a 'note' is to be considered a recommendation rather than a requirement.

The note is included in the criteria section to ensure subject continuity.

*Permanent Vegetative Buffer* (V.A.2.a.(1)) - A strip or area of perennial herbaceous vegetation situated between cropland, grazing land, or disturbed land (including forest land) and environmentally sensitive areas (as defined in NRCS Technical Standard 393, Filter Strip).

*Phosphorus Index (PI)* (V.C.2) - The Wisconsin Phosphorus Index (PI) is an assessment of the potential for a given field to deliver P to surface water. The PI assessment takes into account factors that contribute to P losses in runoff from a field and subsequent transport to a water body, including:

- Soil erosion as calculated using the current approved NRCS soil erosion prediction technology located in Section I of the NRCS FOTG.
- Estimated annual field rainfall and snowmelt runoff volume.
- Soil P concentrations as measured by routine soil test P (Bray P-1).
- Rate and management of P applications in the form of fertilizer, manure, or other organic material.
- Characteristics of the runoff flow pathway from the field to surface water.

The algorithms and software for calculating the Wisconsin PI can be found at <http://wpindex.soils.wisc.edu/>.

*Rotation* (III) - The sequence of crops to be grown for up to an 8-year period as specified by the conservation plan or as part of the soil erosion assessment calculated with the Wisconsin Phosphorus Index model.

*Saturated Soils* (V.A.3.a) - Soils where all pore spaces are occupied by water and where any additional inputs of water or liquid wastes cannot infiltrate into the soil.

*Surface Water Quality Management Areas* (SWQMA) (V.A.2.b.(1)) - For the purposes of nutrient management planning, Surface Water Quality Management Areas are defined as follows:

1. The area within 1,000 feet from the ordinary high-water mark of navigable waters that consist of a lake, pond or flowage, except that, for a navigable water that is a glacial pothole lake, "surface water quality management area" means the area within

1,000 feet from the high-water mark of the lake.

2. The area within 300 feet from the ordinary high-water mark of navigable waters that consists of a river or stream that is defined as:
  - Perennial streams (continuous flow) identified on the NRCS soil survey and/or USGS 1:24,000 scale topographic map as solid lines,
  - Otherwise determined through an onsite evaluation and documented in an approved conservation plan.

Areas within the SWQMA that do not drain to the water body are excluded from this definition.

*Tile Inlet* (V.A.2.a.(4)) - The interception of surface runoff within a concentrated flow channel or field depression, by a constructed device designed to direct runoff into an underground tile for conveyance to surface or groundwater.

*Tolerable Soil Loss (T)* - For sheet and rill erosion (V.A.2.a.(6)) - T-value means the maximum rate of soil erosion established for each soil type that will permit crop productivity to be sustained economically and indefinitely. Erosion calculations shall be based on current approved erosion prediction technology found in NRCS FOTG Section I or the soil loss assessment calculated using the Phosphorous Index Model. Tolerable soil erosion rates shall be determined using the RUSLE2 Related Attributes Report located in Section 2, e-FOTG, Soil Report.

# *A Step-by-Step Guide to Nutrient Management*

*Richard P. Wolkowski*



## ***Introduction***

This publication is designed to help farmers, consultants, governmental agencies, fertilizer dealers, and others determine the crop nutrient requirements of individual fields. The assessment will focus on the primary nutrients – nitrogen (N), phosphorus (P), and potassium (K) – because they represent the largest cost to the farmer and present the greatest risk to the environment when improperly managed. A logical, step-wise process is used to calculate the amount of nutrients needed to grow a crop by accounting for nutrients that are available from several sources.

The assessment begins with the fertilizer recommendations found on the soil test report. The soil test recommendations are based on the level of available nutrients in the soil and the nutrient demand of the crop(s) to be grown. Nutrient credits for soil organic matter, manure, legumes, and/or residual soil nitrate need to be subtracted from the fertilizer recommendation to determine the adjusted nutrient need. Worksheets for conducting field-specific nutrient assessments can be found near the end of this publication. Once completed, this worksheet can be filed with the

soil test report to furnish a record of fertilization and cropping information. Recommendations and credits used in this publication are identical to those used by the University of Wisconsin Soil Testing Program and can also be developed by using the Wisconsin Interactive Soil Program for Economic Fertilizer Recommendations (WISPer) computer program.

Where the University of Wisconsin soil test recommendation program is used, and accurate manure and legume crediting information is provided with the soil samples, nutrient credits are subtracted from the total nutrient requirement. In this case, the adjusted nutrient need has been calculated and the farmer can determine a fertilization program. Where other soil testing programs are used or when a change in management plans occur, the adjusted nutrient need may have to be calculated by the individual grower, farm manager, or crop consultant.

Ideally, nutrients should be applied to fields at rates matching the adjusted nutrient need. However, for reasons of practicality it is expected that fields with similar nutrient recommendations will be grouped together. Then a whole-farm fertilization program can

be developed using the adjusted field nutrient needs from the worksheet to determine a reasonable number of rates and blends of fertilizer materials. An additional worksheet, found at the end of this publication, tallies the adjusted nutrient requirements from individual fields. This can serve as a nutrient management plan for the entire farm.

## Completing the Worksheet

### Step 1. Field Information

Fill in the appropriate information for field identification, year, size, crop, soil name(s), and previous crop. This will provide a condensed record containing the treatment of each field and can serve as a future reference. Enter this information on the worksheet in the space provided in box 1.

### Step 2. Nutrient Need

Determine field-specific nutrient needs by completing the worksheet according to the following directions.

**Recommended N-P<sub>2</sub>O<sub>5</sub>-K<sub>2</sub>O.** From the soil test report form fill in the recommendations for N, phosphate (P<sub>2</sub>O<sub>5</sub>), and potash (K<sub>2</sub>O) in the spaces at line 2a. These are the nutrients which the soil test levels, crop to be grown, and yield goal indicate are needed for each acre in the selected field. University of Wisconsin soil test reports provide nutrient recommendations for two different crop rotation options. It is important to note that nutrient recommendations from soil test reports may not account for nutrient credits when services other than University of Wisconsin or ASCS- approved soil testing laboratories are used.

**Special N-P<sub>2</sub>O<sub>5</sub>-K<sub>2</sub>O.** Certain cropping conditions can affect crop nutrient needs. Special nutrient recommendations are printed as a comment on University of Wisconsin soil test reports. These recommendations are not considered in the cal-

**Table 1. Recommended special fertilization adjustments for special cropping situations.**

Situation	Recommendation
Conservation tillage	Where more than 50% residue cover remains on the surface, increase the N requirement for corn by 30 lb/a N.
Corn silage	Where corn is harvested for silage and soil tests are in the optimum range or below, apply 30 lb P <sub>2</sub> O <sub>5</sub> and 90 lb K <sub>2</sub> O per acre to the succeeding crop. (If soil test P or K exceed the optimal level do not apply the additional nutrients).
Legume forage	Where an alfalfa stand is to be maintained for more than three years increase the annual topdressed potash application by 20%.  Apply 30 lb/a N in the seeding year if grown on soils with less than 2% organic matter.  Apply 40 lb/a N for legume pasture on sandy soils and 20 lb/a N for legume pasture on soils with less than 2 % organic matter.
High P soils	If soil test P levels exceed 150 ppm, do not apply additional P, except for a maximum of 20 lb/a of starter P <sub>2</sub> O <sub>5</sub> for row crops.
N availability tests	Where a N availability test, such as the preplant soil or the pre-sidedress nitrate test has been performed, use the recommended N adjustment.
Nurse crops	Where barley or oats are seeded with a legume forage, reduce N by 50%.
Sandy soils	Recommended N should be applied in sidedress or post emergence split applications.
Sewage sludge	Where sewage sludge is to be applied the soil pH must be 6.5 or higher.

ulation of the report’s fertilizer recommendation. It is the responsibility of the user to include the special nutrient recommendations in the final calculation of nutrient application rates. A summary of the most common of these recommendations is listed in Table 1. Enter any special N, P<sub>2</sub>O<sub>5</sub>, K<sub>2</sub>O recommended at line 2b.

The nutrient need for the primary nutrients can be determined by adding lines 2a and 2b. Fill in the sum for each nutrient at line 2c.

**Starter fertilizer.** It is commonly recommended that a minimal amount of starter fertilizer be applied for corn planted in soils slow to warm in the spring. For corn grown on medium and fine textured soils, apply at least 10 lb N, 20 lb P<sub>2</sub>O<sub>5</sub>, and 20 lb K<sub>2</sub>O per acre at planting as a starter fertilizer. In most row crop fields, all the recommended P<sub>2</sub>O<sub>5</sub> and K<sub>2</sub>O can be applied as starter fertilizer. On soils with test levels in the excessively high range, starter fertilizer applications in excess of 10 lb/a N, 20 lb/a P<sub>2</sub>O<sub>5</sub>, and 20 lb/a K<sub>2</sub>O should be avoided. The amount of N applied as starter fertilizer that exceeds 20 lb/a should be credited against the overall N recommendation.

In-row placement of fertilizer is an efficient means for supplying crop nutrients. The fertilizer is placed near the germinating seed and is immediately available to the crop. Starter fertilizer application is an ideal method of applying a relatively small amount of nutrients to row crops. Starter applications usually supply all the recommended P<sub>2</sub>O<sub>5</sub> and K<sub>2</sub>O for soils testing in the optimum or higher ranges.

**Secondary and micronutrients.** If soil tests for other nutrients (eg., Ca, Mg, S, Zn, B, Mn) were performed, refer to the comments section of the soil test report form to determine if any of the tests indicate a need for secondary or micronutrients. Applications of these nutrients may also be considered without a soil test when there is evidence of a need through plant analysis, visual deficiency symptoms, or previous experience. Enter the recommended application of the appropriate nutrient at line 5a.

**Table 2. Availability estimates for N, P<sub>2</sub>O<sub>5</sub>, and K<sub>2</sub>O for un-analyzed solid manure.**

Animal Type	Available		
	N	P <sub>2</sub> O <sub>5</sub>	K <sub>2</sub> O
	lb per ton		
<b>First Year</b>			
Dairy	3(4) <sup>1</sup>	3	8
Beef	4(4)	5	8
Poultry	13(15)	14	9
Swine	4(5)	3	7
<b>Second Year</b>			
Dairy	4(5)	3	9
Beef	5(6)	6	9
Poultry	15(18)	16	10
Swine	5(6)	4	8
<b>Third or more</b>			
Dairy	5(5)	4	9
Beef	6(6)	6	10
Poultry	16(19)	18	11
Swine	6(7)	4	8

See Nutrient Management Fact Facts for updated information.

<sup>1</sup> Nutrient values in parenthesis are for incorporated manure



**Lime needs.** The need for lime must not be overlooked, because a low soil pH will reduce the response to applied nutrients. Where a lime recommendation is given on the soil test report, enter the recommended rate of 60-69 or 80-89 neutralizing index (NI) lime at line 5b. If the lime to be used has a different NI calculate the amount needed using the equation provided below.

$$\text{Lime to apply} = (t/a \text{ 60-69 required}) \times \frac{65}{\text{Midpoint NI of your lime}}$$

### Step 3. Nutrient Replacement Credit

A goal of nutrient management planning is to allow farmers the opportunity to maximize the value of their on-farm nutrients. For most Wisconsin farms this means utilizing fertilizer replacement credits for legumes, manure, or carry-over soil nitrogen.

**Manure.** Manures contain significant amounts of the primary plant nutrients (N, P, and K), as well as other essential plant nutrients. An accurate manure nutrient credit can be determined only if the *available nutrient content of the manure* and the *manure application rate* are known.

**Table 3. Availability estimates for N, P<sub>2</sub>O<sub>5</sub>, and K<sub>2</sub>O for the application of un-analyzed liquid manure.**

Animal Type	Available		
	N	P <sub>2</sub> O <sub>5</sub>	K <sub>2</sub> O
	lb per 1000 gal		
<b>First Year</b>			
	8(10) <sup>1</sup>	8	21
	10(12)	14	23
	35(41)	38	25
	22(28)	15	26
	12(15)	6	8
<b>Second Year</b>			
Dairy	11(13)	9	24
Beef	14(16)	16	26
Poultry	42(48)	45	28
Swine (f.u.)	28(33)	18	29
Swine (f.n.)	15(18)	7	9
<b>Third or more</b>			
Dairy	13(14)	10	25
Beef	16(18)	17	28
Poultry	45(52)	48	30
Swine (f.u.)	30(36)	19	31
Swine (f.n.)	17(20)	8	9

See Nutrient Management Fast Facts for updated information.

<sup>1</sup> Nutrient values in parenthesis are for incorporated manure.

<sup>2</sup> f.u. = finishing unit; f.n. = farrow nursery

**Table 4. First year availability estimates for N, P<sub>2</sub>O<sub>5</sub>, and K<sub>2</sub>O for analyzed manure.**

Animal Type	First year availability		
	N	P <sub>2</sub> O <sub>5</sub>	K <sub>2</sub> O
	Percent available nutrients		
Dairy	30(35) <sup>1</sup>	55	75
Beef	25(30)	55	75
Poultry	50(60)	55	75
Swine	40(50)	55	75

<sup>1</sup> Nutrient values in parenthesis are for incorporated manure.

For analyzed manure, multiply the total nutrient content by the appropriate percent available nutrients found in Table 5 and the application rate. If manure has been applied to the same field at similar rates for two or three consecutive years, increase the nutrient availability of each nutrient by 10% or 15%, respectively.

Source: USDA-SCS *Wisconsin Field Office Tech. Guide*, Sec. IV-Spec. 590.

### Examples for calculating manure nutrient credit:

#### 1) Not analyzed, first year of application.

$$\frac{\text{Manure applied in tons or gallons}}{\text{acre}} \times \frac{\text{lb Nutrient}}{\text{tons or 1000 gal}} = \frac{\text{lb Nutrient credit}}{\text{acre}}$$

#### a) 30 T/a Solid dairy manure, incorporated.

$$\frac{30 \text{ tons}}{\text{acre}} \times \frac{4 - 3 - 8 \text{ lb (N - P}_2\text{O}_5 - \text{K}_2\text{O)}}{\text{ton}} = \frac{120 - 90 - 240 \text{ lb (N - P}_2\text{O}_5 - \text{K}_2\text{O)}}{\text{acre}}$$

#### b) 10,000 gal/a liquid dairy manure, not incorporated.

$$\frac{10,000 \text{ gal}}{\text{acre}} \times \frac{8 - 8 - 21 \text{ lb (N - P}_2\text{O}_5 - \text{K}_2\text{O)}}{1000 \text{ gal}} = \frac{80 - 80 - 210 \text{ lb (N - P}_2\text{O}_5 - \text{K}_2\text{O)}}{\text{acre}}$$

#### 2) Analyzed, first year of application.

$$\text{Manure application rate} \times \text{Total nutrient content} \times \text{Available nutrient fraction} = \text{Nutrient credit}$$

#### a) 30 T/a solid dairy manure, incorporated.

$$\frac{30 \text{ tons}}{\text{acre}} \times \frac{10 - 6 - 11 \text{ lb (N - P}_2\text{O}_5 - \text{K}_2\text{O)}}{\text{ton}} \times 0.35 - 0.55 - 0.75 \text{ (N - P}_2\text{O}_5 - \text{K}_2\text{O)} = \frac{105 - 99 - 248 \text{ lb (N - P}_2\text{O}_5 - \text{K}_2\text{O)}}{\text{acre}}$$

Manures vary in nutrient content depending upon the animal type and livestock management system. Nutrients contained in manures are not immediately available to crops but are gradually released over time. Therefore, the amount of nutrients which should be credited from manure increases if applications are made to the same field for consecutive years. The N credit increases each successive year of application (up to three consecutive years) by approximately 30%. For example, N credits with consecutive applications of surface-applied dairy manure are 3, 4, and 5 lb/ton N in the first, second, and third or more years of application, respectively (Table 2). Credits for P and K increase somewhat less.

There are several methods that can be used to determine the manure application rate.

These include:

- 1) weighing a full spreader or estimating weight according to spreader volume and calculating the number of loads needed to cover a known acreage;
- 2) calculating the spreader output by driving at a constant speed over a plastic sheet of known size and weighing the manure collected on the sheet; or
- 3) calculating the manure output of confined animals based on their size and type.

Consult UWEX publication A3537, *Nitrogen Credits for Manure Applications*, for more information on estimating manure application rates.

**Table 5. Nitrogen credit for legumes.**

Legume crop	N Credit	Special Considerations
<i>Forages</i>		
<b>FIRST YEAR CREDIT</b>		
Alfalfa	190 lb N/acre for a good stand <sup>1</sup> 160 lb N/acre for a fair stand <sup>1</sup> 130 lb N/acre for a poor stand <sup>1</sup>	Reduce credit by 50 lb N/acre on sandy soils. <sup>2</sup> Reduce credit by 40 lb N/acre if less than 8 inches of regrowth after last harvest.
Red clover Birdsfoot trefoil	Use 80% of alfalfa credit	Same as alfalfa.
<b>SECOND YEAR CREDIT</b>		
Fair or good stand	50 lb N/acre	No credit on sandy soils. <sup>2</sup>
<i>Soybeans</i>	40 lb N/acre	No credit on sandy soils. <sup>2</sup>
<i>Leguminous vegetables</i>		
Peas Snapbeans Lima beans	20 lb N/a	No credit on sandy soils. <sup>2</sup>
<i>Green Manure</i>		
Alfalfa Red Clover Sweet Clover	60-100 lb N/acre 50-80 lb N/acre 80-120 lb N/acre	Use 20 lb N/acre credit if field has less than 6 inches of growth before tillage, killing frost, or herbicide application.

<sup>1</sup>A good stand of alfalfa (70-100% alfalfa) has more than 4 plants/ft<sup>2</sup>; a fair stand (30-70% alfalfa) has 1.5 to 4 plants/ft<sup>2</sup>; and a poor stand (<30% alfalfa) has less than 1.5 plant/ft<sup>2</sup>.

<sup>2</sup>Sandy soils are sands and loamy sands.

### Example for calculating legume nitrogen credit:

#### Alfalfa (fair stand, sandy soil, fall harvest)

Base Credit	Sandy Soil Deduction	Fall Harvest Deduction	Actual Credit
<u>160 lb N</u>	<u>- 50 lb N</u>	<u>- 40 lb N</u>	<u>= 70 lb N</u>
acre	acre	acre	acre

Nutrient losses from manure can be minimized by incorporating surface applied manure within 72 hours. If manure remains on the soil surface, losses of nutrients may occur to the atmosphere or in runoff.

To determine nutrient credits for manure that has not been analyzed, establish the field manure history and use the values in Tables 2 or 3. Multiply the manure application rate by the appropriate nutrient content (lb per ton or lb per 1000 gal). In situations where the nutrient content of manure has been analyzed, multiply the total nutrient content by the appropriate percent available nutrient value (found in Table 4) by the application rate. If analyzed manure has been applied to the same field at similar rates for two consecutive years, increase the nutrient availability of each nutrient by 10%. If manure has been applied to the same field at similar rates for three or more consecutive years, increase the nutrient availability in Table 4 by 15%. Enter the manure credit on line 3a.

The University of Wisconsin soil test recommendations are adjusted for manure applications if accurate manure management information is supplied with the soil samples. Examples for determining manure nutrient credits are provided.

**Legumes.** Legume plants, together with certain soil microorganisms can convert gaseous nitrogen from the air to plant available nitrogen. The most common examples of such plants are alfalfa and soybeans, but trefoil, clovers, beans, and peas are also important in Wisconsin.

A stand condition evaluation is needed to determine the legume credit for forage legumes, while a yield measurement is used for soybeans. For other crops a singular value is used. In some

cases nitrogen credits are affected by soil texture or harvest management.

Use Table 5 to determine the nitrogen credit for legumes. Enter the calculated credit on line 3b. As with manure, if accurate legume cropping information was supplied with soil samples and the University of Wisconsin recommendations are used, the legume credit has already been subtracted. Some examples are provided above.

**Residual nitrate.** Recent research has shown that in some years, significant amounts of N can remain in the root zone from one year to the next where it can be utilized by the following crop. The amount of “carry-over” N is dependent upon previous precipitation, soil texture, and previous crop management. The preplant soil nitrate test measures residual soil nitrate so that N fertilizer recommendations can be reduced to reflect the soil’s residual nitrate content. This test is recommended for corn grown on medium and fine textured soils, in years of normal or below normal precipitation. The test is most useful in years of corn following corn in a rotation. Standard N credit values should be taken for corn following alfalfa or fields where manure was applied the previous fall or spring. More information on the test and the sampling procedure is contained in UWEX Publications A3512 (*Wisconsin’s Preplant Soil Profile Nitrate Test*) and A3624 (*Soil Nitrate Tests for Wisconsin Cropping Systems*). If a preplant soil nitrate test has been performed, enter the credit on line 3c.

**Other nutrients.** Nutrients can be credited from other sources if the nutrient content and rate of application of the material is known. Most of these sources would be organic wastes or by-products such as sewage sludge, whey, or cannery wastes. Some inorganic wastes such as papermill lime-sludge or fly ash are recognized for their liming ability, but may also contain significant levels of plant nutrients. Availability of the nutrients in these materials may vary. The available N-P<sub>2</sub>O<sub>5</sub>-K<sub>2</sub>O should be requested from the supplier. Enter the available nutrient content on line 3d.

**Total nutrient credit.** The Total Nutrient Credits for N-P<sub>2</sub>O<sub>5</sub>-K<sub>2</sub>O can be determined by adding lines 3a through 3d. Fill in the sum for each nutrient at line 3e.

#### **Step 4. Adjusted Nutrient Need**

The Adjusted Nutrient Need can be determined for each of the primary nutrients by subtracting the Total Nutrient Credit (line 3e) from the Total Nutrient Need (line 2c). This value represents the amount (lb/a) of available nutrients needed from commercial or non-commercial fertilizer sources. Enter this value under the appropriate nutrient in box 4.

The adjusted nutrient need assumes that nutrients, whether from fertilizer, manure, or some other source, are applied in a manner that will minimize loss. Therefore, management decisions related to placement, timing, source, and method must still be considered. For example, urea-containing fertilizers should be incorporated to reduce the loss of nitrogen by ammonia volatilization. On sandy soils, nitrogen should be sidedressed to reduce the potential loss by leaching.

Over-application of nutrients occurs where nutrient credits exceed nutrient recommendations – or when fertilizer recommendations are developed without assessing (or only partially assessing) nutri-

ent credits. In fields where N credits exceed N recommendations, decrease or omit N additions from manure or other materials, or plant a crop that has a higher N requirement. Where P or K are the nutrients of concern, monitor nutrient build-up by frequent soil testing. High and/or continuous applications of manure lead to elevated soil test P and K levels. This is often the case with fields near the barn. If soil test levels exceed 150 ppm P, every effort should be made to distribute manure to lower testing fields in order to maximize the agronomic benefits of manure-supplied nutrients.

#### **Step 5. Farmstead Nutrient Use Summary**

A nutrient management plan for determining crop nutrient need can be developed for any farm. The result of a sound nutrient management plan can be increased economic returns and decreased risks to the environment. After the nutrient needs of individual fields have been determined, it would be helpful to summarize the entire farm nutrient requirements on a single summary sheet. The Farmstead Nutrient Use Summary Worksheet (found at the end of this publication) can be completed by transferring the total nutrient need, total nutrient credit, and adjusted nutrient need information from the field-specific worksheets to the summary sheet. The farmstead worksheet will provide a record of nutrient use on the farm and can serve as a component of a farm nutrient management plan.

To determine the supplemental fertilizer requirement for the whole farm, it may be helpful to group fields by crop and similar adjusted nutrient need. Fields with reasonably similar nutrient needs can be treated alike. For corn production, nutrient applications can most easily be fine-tuned by adjusting the starter (row) fertilizer rate. By grouping similar fields according to nutrient need, a single grade of starter fertilizer for corn could be purchased and applied at variable rates that match field nutrient needs.



# Worksheet for a Step-by-Step Guide to Nutrient Management on Your Farm

Complete One Form Per Field

## 1. Field Information

a) Field ID \_\_\_\_\_ c) Acres \_\_\_\_\_ e) Soil name \_\_\_\_\_  
 b) Year \_\_\_\_\_ d) Crop to be grown \_\_\_\_\_ f) Previous crop \_\_\_\_\_

## 2. Nutrient Need

	N (lbs/acre)	P <sub>2</sub> O <sub>5</sub> (lbs/acre)	K <sub>2</sub> O (lbs/acre)
a) Nutrient recommendations soil test report	_____	_____	_____
b) Special nutrient need (from table 1)	_____	_____	_____
c) <i>Total nutrient need</i>			

## 3. Nutrient Credit

a) Manure (from table 2, 3, or 4)	_____	_____	_____
b) Legume (from table 5)	_____	_____	_____
c) Residual nitrate (if test was not conducted enter 0)	_____	_____	_____
d) Other sources (whey, sludge, etc., must have sample analysis)	_____	_____	_____
e) <i>Total nutrient credit</i>			

## 4. Adjusted Nutrient Need

(Total nutrient need - Total nutrient credit)

--	--	--

## Other Nutrient Needs

a) Secondary and micronutrients

Specific nutrient \_\_\_\_\_

Application rate (lb/acre) \_\_\_\_\_

b) Lime

Application rate (tons/acre) \_\_\_\_\_

# Worksheet for a Step-by-Step Guide to Nutrient Management on Your Farm

Complete One Form Per Field

## 1. Field Information

a) Field ID \_\_\_\_\_ c) Acres \_\_\_\_\_ e) Soil name \_\_\_\_\_  
 b) Year \_\_\_\_\_ d) Crop to be grown \_\_\_\_\_ f) Previous crop \_\_\_\_\_

## 2. Nutrient Need

	N (lbs/acre)	P <sub>2</sub> O <sub>5</sub> (lbs/acre)	K <sub>2</sub> O (lbs/acre)
a) Nutrient recommendations soil test report	_____	_____	_____
b) Special nutrient need (from table 1)	_____	_____	_____
c) Total nutrient need	[ ]	[ ]	[ ]

## 3. Nutrient Credit

a) Manure (from table 2, 3, or 4)	_____	_____	_____
b) Legume (from table 5)	_____	_____	_____
c) Residual nitrate (if test was not conducted enter 0)	_____	_____	_____
d) Other sources (whey, sludge, etc., must have sample analysis)	_____	_____	_____
e) Total nutrient credit	[ ]	[ ]	[ ]

## 4. Adjusted Nutrient Need

(Total nutrient need - Total nutrient credit)

[ ]	[ ]	[ ]
-----	-----	-----

## Other Nutrient Needs

a) Secondary and micronutrients

Specific nutrient \_\_\_\_\_

Application rate (lb/acre) \_\_\_\_\_

b) Lime

Application rate (tons/acre) \_\_\_\_\_



# Workspace

---

**Author:** Richard P. Wolkowski is an outreach program manager in the Department of Soil Science, University of Wisconsin-Madison, and extension soil science specialist, University of Wisconsin-Extension. Typesetting by Kimberly Binning, Editor, Nutrient and Pest Management program, University of Wisconsin-Madison.“



*A Step-by-Step Guide to Nutrient Management* is published by the Nutrient and Pest Management (NPM) program. NPM links the research base of the Center for Integrated Agricultural Systems of the UW-Madison College of Agricultural and Life Sciences with Wisconsin’s agricultural community.“

**This publication is available** from your Wisconsin County Extension office or from: Extension Publications, Rm. 245, 30 N. Murray St., Madison, Wisconsin 53715, Phone 608-262-3346. Contact Extension Publications to determine availability before publicizing.“

University of Wisconsin-Extension, Cooperative Extension, in cooperation with the U.S. Department of Agriculture and Wisconsin counties, publishes this information to further the purpose of the May 8 and June 30, 1914 acts of Congress; and provides equal opportunities in employment and programming including Title IX requirements.“

**A3568 A Step-by-Step Guide to Nutrient Management**

# What Is A Farm Nutrient Management Plan?

*Ideally, a farm nutrient management plan is a strategy for obtaining the maximum return from your on-and off-farm fertilizer resources in a manner that protects the quality of nearby water resources. Sounds easy, right? Well in many cases it is. In others, nutrient management planning involves some unique challenges. All plans require thought and understanding between the person developing the plan and the person following the plan—the farmer!*



*There are basic components to all farm nutrient management plans. These include the following:*

## Soil Test Reports

Complete and accurate soil tests are the starting point of any farm nutrient management plan. All cropland fields must be tested or have been tested within the last three years. From the soil test results, the base fertilizer recommendations for each field are given.

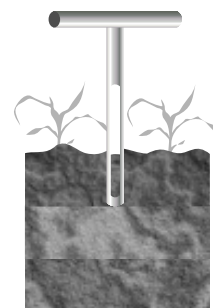

## Assessment Of On-Farm Nutrient Resources

The amount of crop nutrients supplied to your fields from on-farm nutrient resources such as manure, legumes, and organic wastes need to be determined and deducted from your base fertilizer recommendations.



Manure applications to fields supply crops with nitrogen, phosphorus, and potassium—as well as sulfur and organic matter. Legume crops such as alfalfa, clover, soybean, etc. supply nitrogen to the crops that follow them.



## Nutrient Crediting

Once your on-farm nutrient resources are determined, your commercial fertilizer applications should be adjusted to reflect these nutrient credits. This action will not only reduce your commercial fertilizer bills, but it will also protect water quality by eliminating nutrient applications that are in excess of crop need. It has been shown that excessive nutrient additions to cropland can result in contamination of both ground water as well as lakes and streams.



Management skills come into play when determining nutrient credits. For example, to properly credit the nutrients supplied from manure, a grower must know both the manure application rate and the crop-available nutrient content of the manure. To credit the nitrogen available to crops following alfalfa, the condition of the alfalfa stand as well as last cutting date need to be known.

## Consistent With Your Farm Conservation Plan

A nutrient management plan needs to be consistent with your farm conservation plan. If you participate in any federal farm programs, you probably have a soil conservation plan for your farm. The conservation plan is another important component of any nutrient management plan for it contains needed information on your planned crop rotations, identification of the slopes of all fields (which is important when planning manure applications), and the conservation measures you are following to maintain your soil erosion rates at “T” or tolerable rates.

In the event that you do not have a soil conservation plan for your farm, or your existing plan farm does not meet “T”, the information contained in a conservation plan will have to be obtained before a nutrient management plan can be developed. This usually means a that revised or new soil conservation plan will need to be prepared for your farm.



## Manure Inventory

Probably the most challenging aspect of developing and implementing a farm nutrient management plan is the advance planning of manure applications to cropland fields. This involves estimating the amount of manure produced on the farm and then planning specific manure application rates for individual cropland fields. Sounds challenging—and it is, but there are some tricks to the trade.



One of them is calibrating your manure spreader. This is done using scales—either your own platform scales or portable axle scales available from your county Extension or Land Conservation office. By calibrating your manure spreader, you will know the number of tons of manure your spreader typically holds. Once this is known, a specific number of spreader loads can be applied to a given field in order to deliver a planned manure application rate.

## Manure Spreading Plan

The majority of any nutrient management plan for farms with livestock will deal with a manure spreading plan. The amount of manure the farm produces has to be applied to fields in a manner that makes sense both environmentally and agronomically.



Planned manure applications should be made at rates that do not exceed crop nutrient need as identified in the soil test report. The nutrient management plan will also prioritize those fields that would benefit the most from the manure-supplied nutrients while posing little threat to water quality. Also, the nutrient management plan will identify those fields that have manure spreading restrictions. Examples of such restrictions would be fields adjacent to lakes and streams, sloping fields where the threat of spring runoff prohibits manure applications in the winter, and fields in the vicinity of wells, sinkholes, or fractured bedrock.

## Manure Spreading Plan (continued)

The seasonal timing of manure applications to cropland will also be identified in the farm nutrient management plan. The timing of planned manure applications will depend upon each farm's manure handling system. Manure application periods for a farmer with manure storage will be significantly different than that of a farmer who has to haul manure on a daily basis.



## The 590 Nutrient Management Standard

You may have heard or read about something called the “590 standard” and you might be wondering what it is and what it has to do with nutrient management planning. The 590 standard is a USDA-Natural Resources Conservation Service (formerly Soil Conservation Service) document that defines the minimum requirements and components of an acceptable nutrient management plan. A nutrient management plan meeting the 590 standard is a requirement for participation in some federal and state farm programs involving cost-sharing. A farm nutrient management plan that meets the 590 standard is also a requirement of some county ordinances dealing with the construction of manure storage facilities or livestock expansion.



## Contents

Chapter 7: Weeds . . . . .	1
Monocot Weed Seedling Identification Key . . . . .	2
Monocot Weed Identification Key . . . . .	3
Identification of Common Wisconsin Weeds . . . . .	4
Yellow nutsedge . . . . .	4
Barnyardgrass . . . . .	4
Yellow foxtail . . . . .	4
Sandbur . . . . .	4
Giant foxtail . . . . .	5
Green foxtail . . . . .	5
Green/white robust foxtail . . . . .	5
Witchgrass . . . . .	5
Wild proso millet . . . . .	5
Fall panicum . . . . .	6
Woolly cupgrass . . . . .	6
Shattercane . . . . .	6
Large Crabgrass . . . . .	6
Smooth Crabgrass . . . . .	6
Quackgrass . . . . .	7
Wirestem muhly . . . . .	7
Identification of Common Wisconsin Weeds . . . . .	8
Wild buckwheat * . . . . .	8
Pennsylvania smartweed . . . . .	8
Ladysthumb smartweed . . . . .	8
Common lambsquarters . . . . .	9
Redroot pigweed . . . . .	9
Smooth pigweed . . . . .	9
Waterhemp . . . . .	10
Purslane . . . . .	10
Wild mustard . . . . .	10
Wild radish . . . . .	11
Shepherd's purse . . . . .	11

Field pennycress . . . . .	11
Velvetleaf . . . . .	12
Jimson weed . . . . .	12
Eastern black nightshade . . . . .	12
Hairy nightshade. . . . .	13
Bur Cucumber . . . . .	13
Common ragweed . . . . .	13
Giant ragweed . . . . .	14
Horseweed . . . . .	14
Galinsoga . . . . .	14
Prickly Lettuce . . . . .	15
Cocklebur . . . . .	15
Burdock . . . . .	15
Musk thistle . . . . .	16
Plumeless thistle . . . . .	16
Bull thistle . . . . .	16
Horsetail . . . . .	17
Curly dock . . . . .	17
White cockle . . . . .	17
Yellow rocket . . . . .	18
Hoary alyssum . . . . .	18
Leafy Spurge . . . . .	18
Hemp dogbane . . . . .	19
Common Milkweed . . . . .	19
Field bindweed . . . . .	19
Hedge bindweed . . . . .	20
Horsenettle . . . . .	20
Blackseed Plantain . . . . .	20
Canada thistle . . . . .	21
Perennial SowThistle . . . . .	21
Dandelion . . . . .	21

Key Characteristics of Several Plant Families 22

# Monocot Weed Seedling Identification Key

Monocot seedling identification can be challenging. Careful attention to detail is required. Check the drawings for key terms and structures that you need to know to successfully identify plants in this group. Then examine the leaf collar, leaf blade, leaf sheath and shoot of the weed in question and follow the key on the next page.

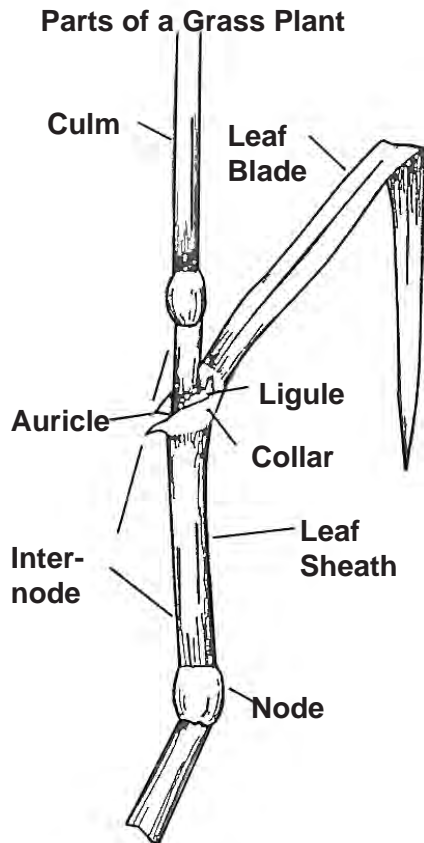

## Terminology of Grass Leaves

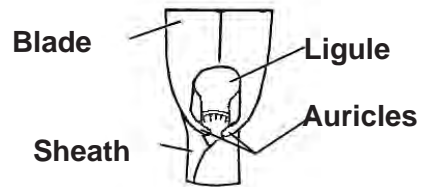

## Leaf Arrangement in Young Shoot

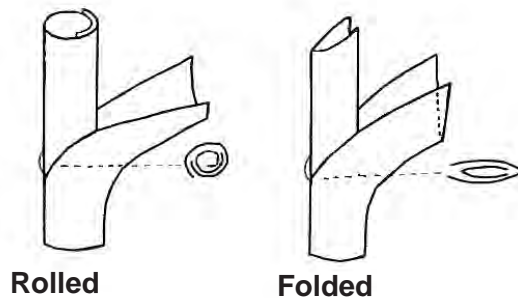

## Ligule Types

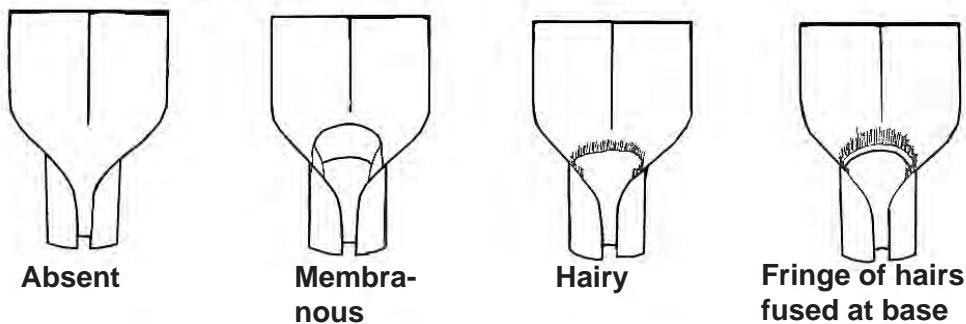

## Ligule Margins

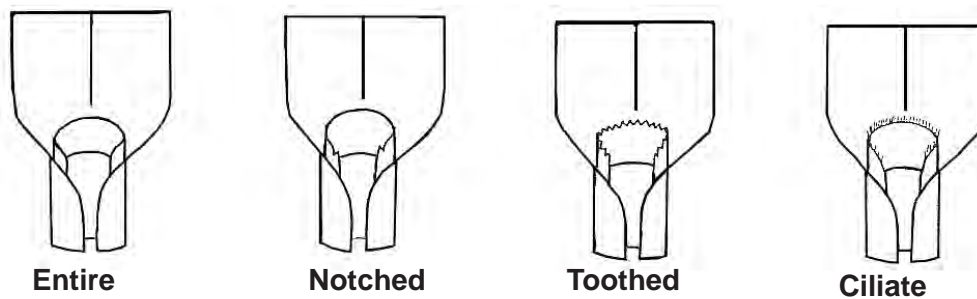



# Monocot Weed Identification Key

Grass and grass-like weeds pose some of the greatest challenges in weed identification. Accurate identification, even at the difficult seedling stage, is however crucial to formulating a successful weed management strategy. Although this key is not all inclusive (it covers 14 grasses and 1 sedge), these are the grasses which predominate Wisconsin agriculture.

To use this key, begin by determining the absence or presence of a ligule (diagrams defining identification terminology can be found on the back side of this page), checking for hairs on the leaf blade and sheath, and then determining if any of the confirming traits are present. This key is meant to be a quick and concise identification tool. If you are left with any question concerning the identification of a weed, consult one of the many in-depth weed identification guides readily available today.

Ligule	Hairs present on:		Confirming Traits	The Weed Is...
	Blade	Sheath		
none	no	no	Triangular stems, 3-ranked waxy leaves, tubers at end of rhizomes	Yellow Nutsedge
none	no	no	Stem sharply flattened, leaf collar yellowish	Barnyardgrass
hairy	long wiry hairs at base of blade	no	Stem flattened, cylindrical seed heads with yellowish awns	Yellow Foxtail
hairy	no	occasionally on sheath margin	Stem flattened with purplish bases, common on sandy soils, twisted leaves & spiny fruit	Sandbur
hairy	no	margin – yes surface – rarely	Seed head tapers at tip, purple & white biotypes exist (rare)	Green Foxtail
hairy	short hairs on entire upper surface	margin – yes surface – rarely	Large drooping seedheads	Giant Foxtail
hairy	few hairs on blade near ligule	sheaths of first tillers hairy	Prominent midrib white on older plants, stem bases often purplish	Fall Panicum
hairy	very hairy upper and lower surface	covered with bristly hairs	Rounded stems, open panicle seed head with very small seeds	Witchgrass
hairy	some hairs on both leaf surfaces	covered with bristly hairs	Tan to black shiny seeds, often attached to root	Wild Proso Millet
hairy	short hairs on both upper & lower surface	covered with short, fine hairs	First leaf relatively wide, 900 to stem, stem nodes swollen, one leaf margin often wrinkled	Woolly Cupgrass
membranous (very short)	no	sheaths hairy in spring	Whitish-yellow leaf collar with clasping auricles, long rhizomes	Quackgrass
membranous	no	no	Jagged ligule, wire-like stems with narrow leaves, short scaly rhizomes, plant appears bushy	Wirestem Muhly
membranous	yes	yes	Flattened stems, low spreading growth, roots at nodes	Large Crabgrass
membranous	sparse if present	sparse if present	Lighter green, smaller and less hairy than large crabgrass	Smooth Crabgrass
membranous initially (hairy later)	no	no	Stems round, leaf blades wide, large black & shiny seeds often attached to root	Shattercane

# Identification of Common Wisconsin Weeds

## Annual & Perennial Monocots

### SEDGE FAMILY

#### Yellow nutsedge

- stems: triangular, nodeless and solid
- leaves: 3-ranked, shiny and waxy; basal and involucrel
- flowers: small, yellowish to yellowish-brown
- rhizomes: 4" - 12" long tubers formed at the end of rhizomes
- other: seeds brownish, 3 sided; perennial

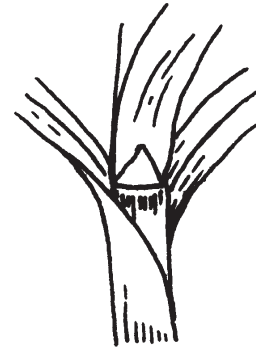

### GRASS FAMILY

#### Barnyardgrass

- stems: flattened
- leaves: smooth; occasionally few hairs in leaf collar area
- ligule: absent
- other: seed head has awns that vary in length

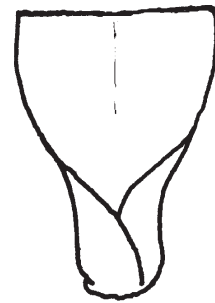

### GRASS FAMILY

#### Yellow foxtail

- stems: flattened
- leaves: long hairs on upper surface at base of blade
- ligule: hairy
- other: seed head is yellowish color, bristly, cylindrical and erect



### GRASS FAMILY

#### Sandbur

- stems: flattened; base often reddish
- leaves: smooth, twisted
- ligule: hairy
- other: found mostly on sandy soil; fruit a spiny bur

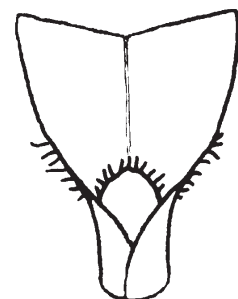

# Annual & Perennial Monocots

## GRASS FAMILY

### Giant foxtail

- stems: rounded to slightly flat
- leaves: short hairs on upper surface only; hairy sheath margin
- ligule: hairy
- other: seed head is large and drooping

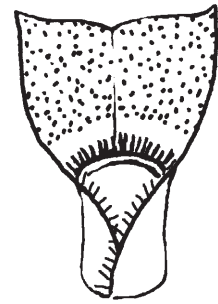

## GRASS FAMILY

### Green foxtail

- stems: rounded to flattened
- leaves: no hairs on blade; hairy sheath margin
- ligule: hairy
- other: seed head usually smaller than giant foxtail; larger at base and tapering at tip.

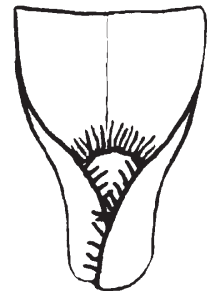

## GRASS FAMILY

### Green/white robust foxtail

- Plants usually larger than green foxtail; no hair on blade; large, drooping seedheads with purple or white bristles

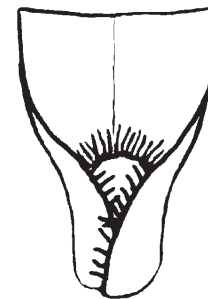

## GRASS FAMILY

### Witchgrass

- stems: rounded; semi-decumbent
- leaves: sheath and blade very hairy
- ligule: hairy
- other: seed head on open panicle with very small seeds

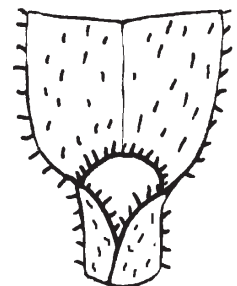

## GRASS FAMILY

### Wild proso millet

- stems: rounded, with many tillers
- leaves: hairy blades, always on top, sometimes below; sheath always bristly hairy
- ligule: hairy
- other: relatively large tan to black shiny seeds

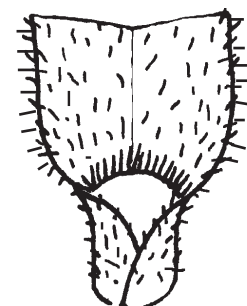

# Annual & Perennial Monocots

## GRASS FAMILY

### Fall panicum

- stems: rounded, with a reddish-purple base
- leaves: first leaf sheaths hairy; later smooth; sheath margin smooth; few hairs at blade base; prominent midrib
- ligule: hairy
- other: seeds smaller than wild proso millet

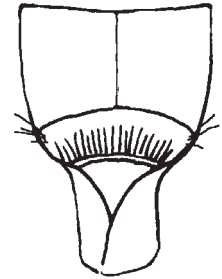

## GRASS FAMILY

### Woolly cupgrass

- stems: rounded stems with swollen nodes
- leaves: blades & sheath finely pubescent; blade wrinkled on one edge
- ligule: hairy, short
- seeds: large straw-colored seeds
- seed head: composed of several branches (*rachis*)

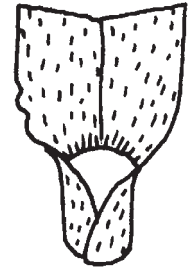

## GRASS FAMILY

### Shattercane

- stems: rounded, large and with many tillers
- leaves: sorghum-like; white midrib above and prominent below
- ligule: membranous with hairs on top by midseason
- seed head and seeds: panicle inflorescence, a panicle; relatively large black, shiny seeds
- other: grows 4-8 feet tall; if rhimomes found, it is sorghum alnum

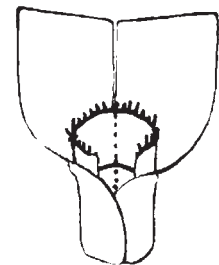

## GRASS FAMILY

### Large Crabgrass

- stems: rounded to flattened, decumbent and branched
- ligule: membranous
- leaves: sheath & blade hairy
- seedhead: a branched finger-like structure; seeds flattened against branches
- other: roots often form at nodes

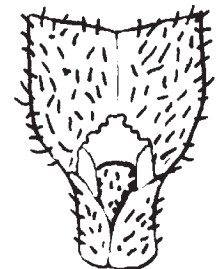

## GRASS FAMILY

### Smooth Crabgrass

- Similar to large crabgrass but few if any hairs on leaf sheath and blade;
- smaller; lighter green color

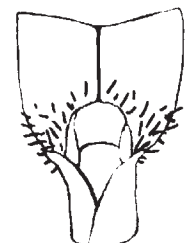

# Annual & Perennial Monocots

## GRASS FAMILY

### Quackgrass

- stems: rounded
- leaves: sheath hairy early
- ligule: membranous; very short and hard to see
- auricles: clasping (*Barley & wheat have also*)
- rhizomes: long, whitish, slender
- other: perennial, cool season

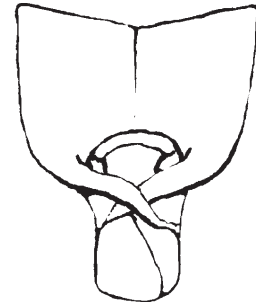

## GRASS FAMILY

### Wirestem muhly

- stems: rounded; wiry
- leaves: numerous, relatively short, narrow, pale green
- ligule: membranous; easily visible
- auricles: absent
- rhizomes: short, scaly, irregularly shaped; short internodes = many buds
- other: perennial, warm season; prolific seed producer

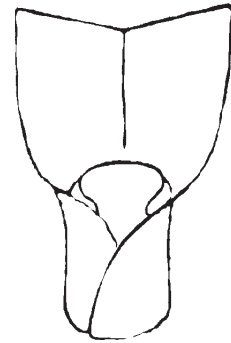



# Identification of Common Wisconsin Weeds

## Annual Broadleaves

### BUCKWHEAT FAMILY

#### Wild buckwheat \*

- cotyledon: oblong-oval with granular-waxy surface
- ocrea: at leaf axils; small
- stems: trailing vines
- leaves: heart-shaped with pointed tips
- flowers: greenish-white, small and inconspicuous
- seeds: 3-sided

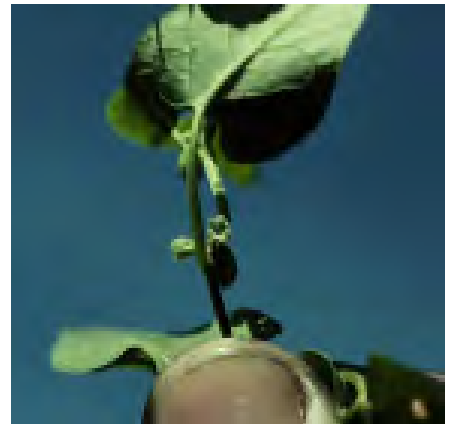

### BUCKWHEAT FAMILY

#### Pennsylvania smartweed

- cotyledon: lanceolate to oblong, rounded tips
- ocrea: at leaf axils; smooth top
- stems: reddish, branched swollen nodes
- leaves: rounded at base; pointed at tip
- flowers: pink, terminal flower clusters
- other: seed black, shiny, flattened, circular with pointed tip



### BUCKWHEAT FAMILY

#### Ladysthumb smartweed

- cotyledon: lanceolate to oblong, rounded tips
- ocrea: at leaf axils; hairy top
- stem: reddish with swollen nodes; branched
- leaves: pointed at both ends, often have "thumb print"
- flowers: pink, terminal flower clusters
- other: seeds black, most triangular

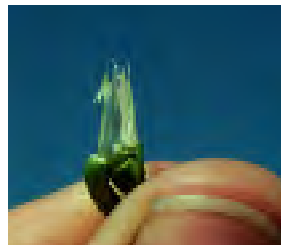

# Annual Broadleaves

## GOOSEFOOT FAMILY

### Common lambsquarters

- cotyledon: linear, small
- leaves: often have whitish, 'mealy' covering; shape is triangular or "goosefoot" shaped
- stems: have reddish streaks, branched
- seed: shiny, black, disk-shaped, 1/16 inch in diameter
- other: many biotypes, some resistant to herbicides

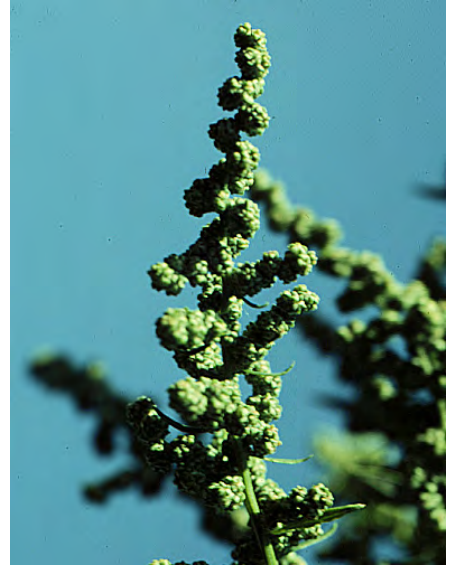

## PIGWEED FAMILY

### Redroot pigweed

- cotyledon: linear, smooth
- root: often reddish-pink taproot
- leaves & stems: notch in tip of first leaves; finely pubescent; reddish-purple color on underside of leaves
- seed head: somewhat spiny, small, black, shiny seeds
- other: also called rough pigweed

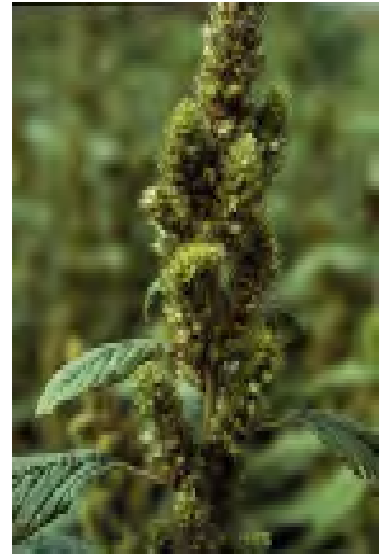

## PIGWEED FAMILY

### Smooth pigweed

- cotyledon shape: linear, smooth
- root: often reddish pink taproot
- leaves & stems: generally smooth
- seed heads: longer than redroot pigweed ; rarely branched
- other: resistant biotypes

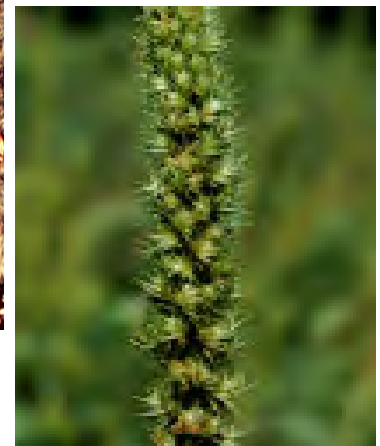
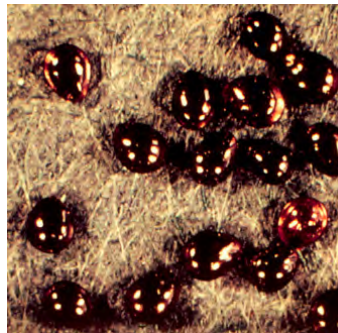

# Annual Broadleaves

## PIGWEEED FAMILY

### Waterhemp

cotyledon

shape: linear; egg-shaped

leaves: nick in tip of first leaves; long-petioled; 3 to 6 in. long; somewhat shiny

stems: smooth, often with colored stripes

inflorescence: small greenish flowers, male and female flowers on separate plants

other: several species of waterhemp in the region; resistant biotypes

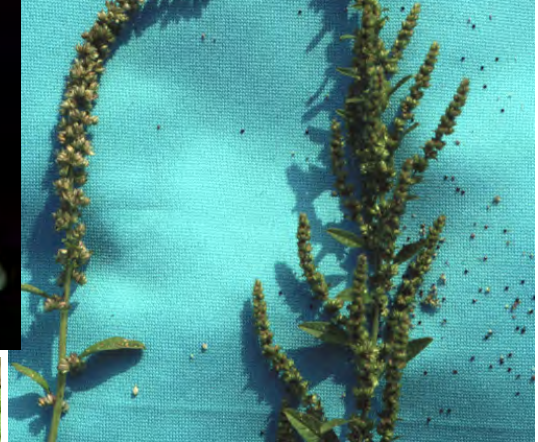

## PURSLANE FAMILY

### Purslane

cotyledon: linear or oblong, smooth

leaves: fleshy, rounded, opposite

stems: fleshy, prostrate, reddish, branched

flowers: 5 yellow petals; small; numerous

seeds: small, flattened, oval, glossy black

other: plants can establish from stem pieces



## MUSTARD FAMILY

### Wild mustard

cotyledon: heart or kidney-shaped; smooth

leaves

and stems: few bristly hairs

lower leaves: large, triangular and lobed (not to midrib)

upper

leaves: reduced in size; no petioles

flowers: 4 bright yellow petals

seed pods: "beak" of seed capsule 1/3 length of whole capsule; open to release round seeds

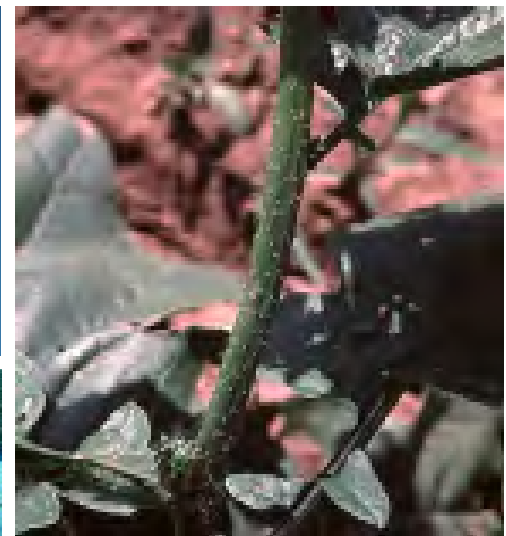
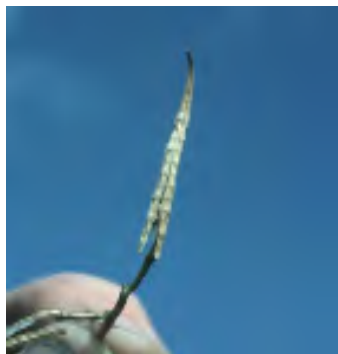



# Annual Broadleaves

## MUSTARD FAMILY

### Wild radish

- cotyledon: heart or kidney-shaped, smooth
- lower leaves: rounded lobes often reach to midrib
- stems & leaves: stiff, scattered hairs
- flowers: 4 yellowish-white petals; sometimes with purplish veins
- seed pods: form constrictions and break into small segments with seed inside
- other: fruits contaminate oats and barley grain



## MUSTARD FAMILY

### Shepherd's purse

- cotyledon shape: ovate to rounded
- rosette leaves: starlike branched hairs on upper surface; leaf lobes point to leaf tip
- stalk/stems: elongated stalk; leaves clasp stem
- flowers: small with 4 white petals
- seed pod: small, triangular-shaped



## MUSTARD FAMILY

### Field pennycress

- cotyledon: round, bluish-green
- leaves: rosette and stem leaves; ear-like lobes that clasp stems on upper leaves
- flowers: flowers with 4 white petals; in clusters
- seed pod: notch in top of pod and flat wing around edge
- other: garlic-like odor in crushed leaves and stems



# Annual Broadleaves

## MALLOW FAMILY

### Velvetleaf

- cotyledon: round or heart-shaped
- leaves: very large, heart-shaped, softly hairy
- stem: pubescent
- flowers: yellow with 5 petals
- seed
- capsules: 13-15 segments; resembles "butterprint"

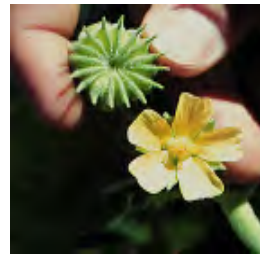
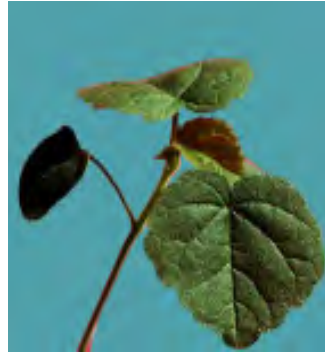

## NIGHTSHADE FAMILY

### Jimson weed

- cotyledon: lanceolate, smooth
- leaves: ovate (egg-shaped) with pointed tip lobes; wavy margins
- stems: hollow, purplish, and smooth
- flower: white tubular flowers
- seed
- capsules: spiny, golf ball sized with many seeds
- other: strong, foul odor in leaves and stems; poisonous



## NIGHTSHADE FAMILY

### Eastern black nightshade

- cotyledon: ovate, smooth, small
- leaves: purplish color on underside of young leaves; often with "shot holes"
- stems: erect or spreading; widely branched
- flowers: 5 white reflexed petals
- fruits: green, turning black at maturity; contaminate harvested products

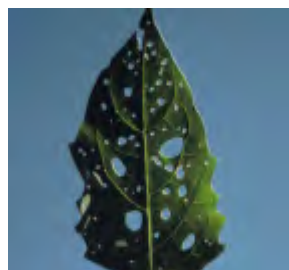



# Annual Broadleaves

## NIGHTSHADE FAMILY

### Hairy nightshade

- cotyledon: ovate, hairy
- leaves: ovate to nearly triangular; finely hairy, especially veins & margins
- stems: finely hairy
- flowers: 3-9 flowers on short stalk; 5-petaled; white or tinged with purple
- fruit: turns olive to brown when ripe



## GOURD FAMILY

### Bur Cucumber

- cotyledon: large; spoon-shaped, thick with dense short hairs
- stem: long, ridged vines; sticky-hairy; branched tendrils allow plants to climb over crops
- leaves: 3 to 5 shallow lobes (pentagon-shaped), alternate, petioled
- flowers: male and female flowers arise at separate axils; 5 greenish-white fused sepals and petals
- fruits: in clusters of 3 to 20 egg-shaped, barbed, prickly pods; each pod with one seed



## COMPOSITE FAMILY

### Common ragweed

- cotyledon: oval to spatulate, thick
- leaves: lacy, finely divided, opposite initially, then alternate; first leaves with 5 lobes
- stems: rough, hairy and branched
- flowers: male flowers in terminal clusters; female flowers in leaf axils

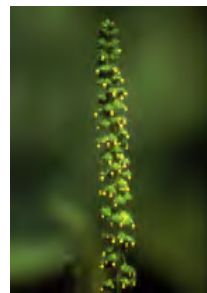

# Annual Broadleaves

## COMPOSITE FAMILY

### Giant ragweed

- cotyledon: oval to spatulate
- leaves: opposite, large and 3-5 lobed; upper leaves often simple; roughly hairy
- stems: woody and 1-2 inches thick; tough, hairy; 6-14 feet tall
- flowers: male flowers in terminal clusters; female flowers in leaf axils



## COMPOSITE FAMILY

### Horseweed

- cotyledon: round to ovate
- leaves: many leaves, no petioles; hairy; entire or toothed
- stems: covered with bristly hairs; branched at top
- flowers: many small flowers on axillary branches
- other: also called mareastail; common in no-till sites



## COMPOSITE FAMILY

### Galinsoga

- cotyledon: oval to squarish, hairy; abruptly tapered at base
- leaves: opposite, toothed
- stems: branched, hairy
- flowers: 4-5 white ray flowers surrounding yellow disk flowers





# Annual Broadleaves

## COMPOSITE FAMILY

### Prickly Lettuce

- cotyledon: ovate to spoon-shaped
- first leaves: rosette of pale green leaves; no spines
- later leaves: lobed with spiny edges and spines on midrib of underside of leaves; leaf bases clasp the stem
- stem: hollow; top very branched when mature
- flowers: pale yellow flower heads that release seeds attached to a pappus
- other: leaves and stems with milky sap

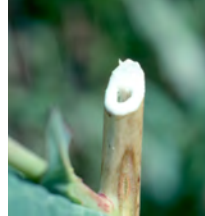

## COMPOSITE FAMILY

### Cocklebur

- cotyledon: lanceolate, thick
- leaves: large, triangular and lobed; 3 prominent veins
- stems: rough texture, dark purple spots
- stem & leaves: sandpaper-like textured surface
- flowers: small, male and female separate but borne together in clusters in axils of upper leaves



# Biennial Broadleaves

## COMPOSITE FAMILY

### Burdock

- taproot: large, thick, and fleshy
- rosette leaves: huge with heart-shaped base; white-woolly below
- stem leaves: alternate, prominent veins
- stem: tough; much branched
- flowers: red-violet color; 3/4 - 1 inch across
- fruit: a bur with hooked spines

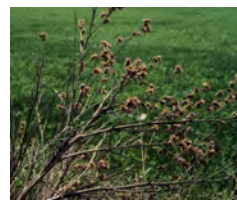

# Biennial Broadleaves

## COMPOSITE FAMILY

### Musk thistle

- leaves: smooth, waxy; grey-green margin with a white, hairless midrib; spiny edges that extend down stem
- stems: spiny from leaf bases except right below flower head
- flowers: 1 ½ to 2 inches in diameter; rich pink color; head often tips downward



## COMPOSITE FAMILY

### Plumeless thistle

- leaves: leaves deeply divided; hairy esp. lower surface midrib; decurrent
- stems: spiny from base to flower head due to decurrent leaves
- flowers: ¾ to 1 ½ inches in diameter; pinkish



## COMPOSITE FAMILY

### Bull thistle

- leaves: deeply cut, spiny margins with a wrinkled surface; hairy
- spines: prominent; needle-like
- stems: spiny with decurrent leaves (extend down the stem)
- flowers: 1 – 2 inches in diameter; are flask-shaped; pink to pink-lavender





# Perennial Broadleaves

## HORSETAIL FAMILY

### Horsetail

spreads: by spores and rhizomes

fertile stems: stems hollow, not branched; easily separated joints

vegetative

stems: "leaves" in whorls at joints; looks like small pine trees

other: most common in wet areas



## BUCKWHEAT FAMILY

### Curly dock

taproot: fleshy, branched, and yellow

ocrea: long; prominent

basal leaves: 6-12 inches with wavy edges

stems: smooth, erect, reddish

flowers: small greenish becoming reddish brown at maturity, found in dense clusters on branches at tip of stem



## PINK FAMILY

### White cockle

leaves: hairy and opposite, with no petiole; softly hairy

stems: softly hairy

flowers: white; male & female parts on separate plants (dioecious)

fruit: seed pods with 10 short teeth

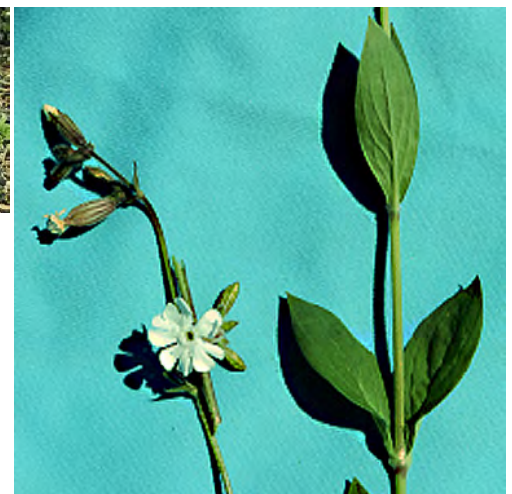
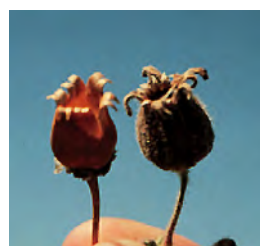



# Perennial Broadleaves

## MUSTARD FAMILY

### Yellow rocket

rosette

leaves: pinnate with large terminal lobe

stem leaves: smooth with waxy surface

upper leaves: clasp stem

flowers: 4 yellow petals, similar to wild mustard but smaller



## MUSTARD FAMILY

### Hoary alyssum

stem/leaves: grey-green in color; rough hairs on whole plant

flowers: white with 4 deeply-divided petals

fruit: seed pods small with short "beak"



## SPURGE FAMILY

### Leafy Spurge

roots: deep and spreading

stems: smooth

leaves: alternate, strap-shaped, ¼ inch wide, usually drooping

flowers: small and borne above greenish-yellow bracts

fruit: explode when ripe, shooting 3 seeds, from parent plant

other: all plant parts have milky sap



# Perennial Broadleaves

## DOGBANE FAMILY

### Hemp dogbane

- roots: deep and branched
- leaves: opposite, narrow and pointed tips
- stems: smooth, reddish
- flowers: 5 greenish white petals that are slightly longer than green sepals
- fruits: long, slender pods; occur in pairs
- other: all plant parts have milky sap



## MILKWEED FAMILY

### Common Milkweed

- roots: deep and branched
- leaves: opposite, thick, oblong, rounded tips, prominent veins
- flowers: pink to white in large many-flowered ball-like clusters at tip of stem and in axils of upper stems
- other: all plant parts have milky sap



## MORNINGGLORY FAMILY

### Field bindweed

- roots: deep and spreading
- stems: trailing or climbing
- leaves: "arrowhead"-shaped leaves with 3 "points"
- flowers: white or pink, funnel-shaped, 1 inch or less in diameter, found in axils of leaves
- other: flower stalks have 2 stipules below flowers





# Perennial Broadleaves

## MORNINGGLORY FAMILY

### Hedge bindweed

- roots: deep and spreading
- stems: trailing or climbing (similar to field bindweed)
- leaves: "arrowhead"-shaped leaves with 5 "points"
- flower stalks: no stipules below flowers
- flowers: large, 1 ½ to 2 inches, white or pinkish



## NIGHTSHADE FAMILY

### Horsenettle

- root: spreading, deep with adventitious buds
- leaves: with yellow prickles on the petioles, veins and midribs; hairy; oblong with wavy edges (like oak leaf)
- stems: with sharp, stout spines; simple or branched
- flowers: potato-like with 5 fused white to purple petals; prominent anthers
- fruits: smooth green berries to 0.5" diameter, becoming yellow; become wrinkled and hang on plants most of winter
- other: plants poisonous

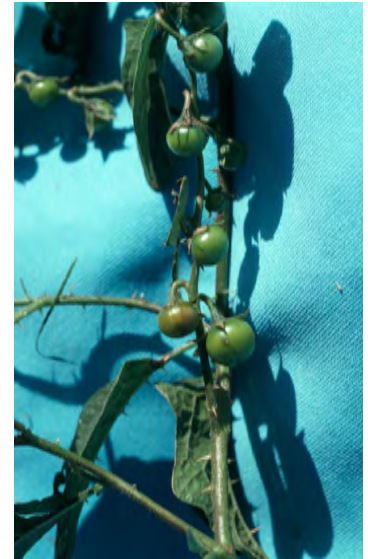

## PLANTAIN FAMILY

### Blackseed Plantain

- root: fibrous, tough
- leaves: in rosette, broad, ovate with 3 to 5 prominent veins; smooth; petioles purplish; egg-shaped, wavy margins
- flowering stems: leafless with many small inconspicuous flowers
- other: broadleaf plantain similar but lacks purple petioles and has smaller leaves



# Perennial Broadleaves

## COMPOSITE FAMILY Canada thistle

- roots: deep and branched
- stems: hairy
- leaves: crinkled edges and spiny margins; smooth
- flowers: pink to purple, flash-shaped rarely white,  $\frac{3}{4}$  inches wide; male and female flowers on separate plants

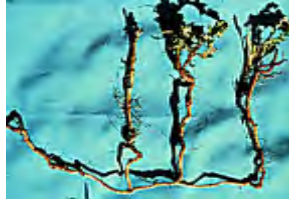

## COMPOSITE FAMILY Perennial SowThistle

- roots: spreading; shoots arise from buds
- leaves: prickly toothed, lobed; milky sap
- stems: milky juice; hollow; branch near top
- flower heads: branched with yellow ray flowers
- seeds: ribbed; with feathery pappus



## COMPOSITE FAMILY Dandelion

- roots: deep taproot with many buds
- leaves: lobes point to base of plant; watery, milky juice
- flowers: bright yellow with many seeds
- seeds: ribbed with barbs to aid in soil penetration; pappus aids in seed spread





# Key Characteristics of Several Plant Families

## A. Amaranthaceae (Pigweed Family) pigweeds, waterhemp

1. annual herbs
2. alternate or opposite leaves
3. inflorescences dense and spike-like
4. flowers small
5. sepals 3-5
6. petals - none
7. stamens -5
8. fruits - achene or capsule-like

## B. Apocynaceae (Dogbane Family) dogbanes

1. perennial herbs, milky sap in all plant parts
2. stems branched, smooth, fibrous
3. leaves opposite, simple, entire
4. inflorescence terminal or axillary cymes
5. petals and sepals - 5 each
6. fruit - long, slender follicles borne in pairs, often curved
7. seed with pappus

## C. Asclepiadaceae (Milkweed Family) milkweeds

1. perennial herbs or vines, most with milky sap in all plant parts
2. stems unbranched
3. leaves opposite or whorled, simple, entire
4. inflorescence terminal or axillary globe-like clusters (umbels)
5. petals and sepals - 5 each; individual flowers have hour-glass shape
6. fruit - a large, cigar-shaped follicle or pod; often in pairs
7. seed with pappus

## D. Caryophyllaceae (Pink Family) chickweed, white cockle

1. herbs
2. annual or perennial
3. opposite entire leaves without petioles
4. nodes usually swollen
5. inflorescences typically cymes
6. flowers - perfect
7. sepals - 5, petals - 5
8. stamens, usually 10
9. fruits - capsules, usually toothed at apex when open

## E. Chenopodiaceae (Goosefoot Family) lam- quarters, kochia

1. succulent plants
2. simple, entire or lobed leaves
3. leaves often mealy in appearance
4. flowers in dense axillary clusters
5. flowers greenish
6. sepals - 5, no petals
7. stamens - 5
8. fruits achene-like

## F. Convolvulaceae (Morningglory Family) bindweeds, dodder

1. twining herbaceous vines
2. sap sometimes milky
3. leaves alternate and simple, frequently heart or arrow-shaped
4. sepals - 5
5. petals - 5, almost always completely united
6. stamens - 5
7. fruits - capsules

## G. Compositae/Asteraceae (Aster Family) very large

1. leaves usually alternate, sometimes opposite or whorled
2. petals - 5,4, or none, in florescene a head of several to >100 flowers
3. ligulate(ray) or tubular(disc) flowers, or both
4. head subtended by involucre bracts
5. pappus of crown-like ridges, scales, awns or bristles
6. fruits achenes

## H. Cruciferae (Mustard family) mustards, wild radish, shepherd's purse

1. leaves mostly alternate
2. inflorescences racemes
3. sepals - 4, petals - 4
4. stamens - 6 (4 long and 2 shorter)
5. fruits, 2-celled siliques

## I. Cyperaceae (Sedge Family) nutsedge

1. annual or perennial herbs
2. triangular solid stems
3. 3-ranked leaves with closed sheaths
4. inflorescences, spikes or panicles
5. style - 1, stigmas - 2 or 3
6. fruits - achenes



**J. Euphorbiaceae (Spurge Family)**  
**prostrate spurge, leafy spurge**

1. annual or perennial herbs
2. mostly with milky juice (sap)
3. alternate, opposite, whorled leaves
4. inflorescences commonly cymes
5. flowers unisexual and highly variable
6. sepals variable or none
7. petals usually absent
8. stamens - 1 to many
9. fruits usually capsules
10. an extremely variable family

**K. Gramineae/ Poaceae (Grass Family)**

1. leaves - alternate, parallel veined; with sheath and blade
2. true stems - round or oval, usually hollow between nodes
3. flowers - in spikelets, no petals, 3 or 6 anthers
4. inflorescence - a spike, panicle or raceme

**L. Labitae (Mint Family) healall, henbit, creeping charlie**

1. annual or perennial
2. mostly aromatic (odor)
3. square stems and opposite or whorled simple leaves
4. flowers 2-lipped
5. sepals - 5, petals - 5
6. stamens - 2 or 4 (unequal pairs if 4)
7. fruits - 4 nutlets

**M. Leguminoseae (Pea Family)**  
**clovers, black medic**

1. alternate, usually compound leaves
2. leaves bear stipules
3. inflorescences mostly racemes
4. flowers mostly perfect and irregular
5. sepals usually 5, often united
6. petals - 5, the upper the largest
7. stamens, mostly 10
8. fruits, legumes (true pods)

**N. Malvaceae (Mallow Family)**  
**velvetleaf, mallows**

1. common in warm climates
2. leaves alternate and usually large, often palmately lobed
3. sepals - 5
4. petals - 5
5. stamens - many
6. fruits - mostly capsules

**O. Plantaginaceae (Plantain Family)**  
**plantains**

1. annual or perennial herbs
2. basal leaves only
3. inflorescences - bracted spikes
4. flowers small
5. sepals - 4, united
6. petals - 4, papery
7. stamens - 2 or mostly 4
8. fruits - circumscissile capsules

**P. Polygonaceae (Buckwheat Family) smart-weeds, knotweeds**

1. alternate simple leaves
2. swollen nodes usually
3. ocrea, covering at nodes
4. sepals 2-6 commonly petal-like
5. petals - none
6. stamens - 4-9
7. fruits - achenes, commonly triangular

**Q. Solonaceae (Nightshade family)**  
**nightshades, groundcherry, jimson weed**

1. leaves alternate
2. many species with rank-smelling foliage
3. some species mildly or severely poisonous
4. flowers tomato or potato-like
5. petals and sepals - 5 each
6. fruit - a many-seeded berry; sepals enclose the fruit in groundcherry
7. fruit of jimsonweed golf ball sized capsule covered with blunt spines.

# Interactive Weed Identification Database Created for Wisconsin

Mark Renz

Extension Weed Scientist, University of Wisconsin-Madison

Have you ever had difficulty identifying a plant and found yourself flipping through pages of a plant identification book looking for a matching picture? This is a common method used, but is not very efficient. Partially because I got tired of doing this myself, I have created a new online weed identification tool to help with weed and invasive plant identification. The database contains 355 of the most common weeds/invasive plants found in agricultural, urban, and natural settings in Wisconsin. The database can be accessed (for free) by going to the website <http://weedid.wisc.edu>. Once you arrive at this website click on the Weed ID Tool on the left column. The database is organized to ask questions about the unknown plant and based on the user's input, the website will produce a list of plants (scientific and common names) along with thumbnail images that match the information entered.

**How does it work?** The website is separated into two steps; first the user is asked if the plant in question is a broadleaf, grasslike, or woody species (See figure 1).

Figure 1: Demonstration of the first step

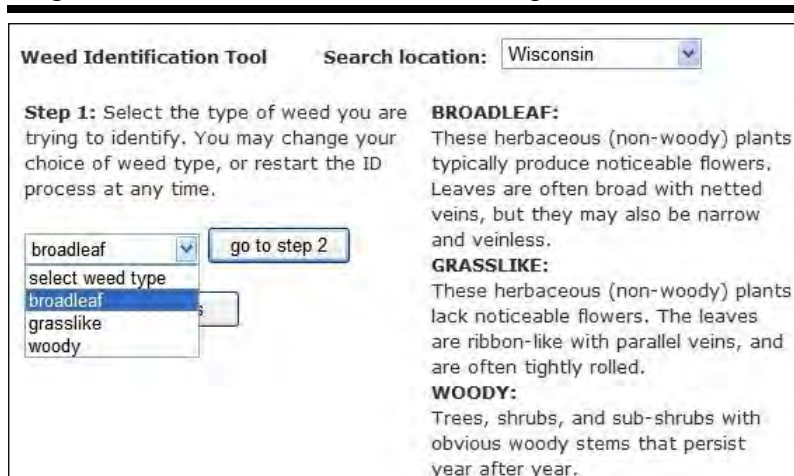

The screenshot shows the 'Weed Identification Tool' interface. At the top, there is a 'Search location:' dropdown menu set to 'Wisconsin'. Below this, the interface is divided into two columns. The left column contains the text: 'Step 1: Select the type of weed you are trying to identify. You may change your choice of weed type, or restart the ID process at any time.' Below this text is a dropdown menu with 'broadleaf' selected, and a 'go to step 2' button. The right column contains three categories: 'BROADLEAF:' with a description of herbaceous plants with noticeable flowers and broad leaves; 'GRASSLIKE:' with a description of herbaceous plants without noticeable flowers and ribbon-like leaves; and 'WOODY:' with a description of trees, shrubs, and sub-shrubs with woody stems.

Once this information is entered it will lead the user to a separate screen that will ask specific questions of each group. Questions ask where it was found as well as specific questions about the growth, leaf, stem, and floral characteristics (see Figures 2 and 3). The user has several answers available to select from a dropdown menu to the right of each question. The user is not required to answer any of these questions, but it is recommended to begin your search by answering just a few questions that are

distinct. If selections result in too many plants, continue to answer additional questions to narrow the number of results. It is rare that the selection will result in one plant, but often a list of several result. The user can quickly scroll down the page looking at the images and click on pictures to verify the identification of the unknown plant. Avoid answering too many questions as one incorrect answer can eliminate the desired plant from the results. Therefore, it is better to answer fewer questions that are unique to the plant (such as plants have spines, thorns, or prickles). The user may change answers and re-search the database to narrow or broaden the search. Leaving all questions unanswered will return all species of the chosen weed type contained in the database.

**Example:** I have a weed species that I recognize is a broadleaf plant with purple flowers and a square stem that I found in a wetland (purple loosestrife). Searching all broadleaf weeds would result in looking at images of over 200 plants, but by just entering that this plant was found in a wetland would reduce the number of plants to 86. Entering that the plant also has purple flowers would further reduce the selected plants to 17. If the user also included that plants had square stems only two plants resulted, purple loosestrife and wild mint. The user could then view the images to see which plant best fit the sample. See figures 2-3 for examples of the output.

Typically answering five to six questions can narrow the search to 10 plants or less. In some cases, the search will result in several species that are very similar and cannot be distinguished by the characteristics

the database uses. In these cases it is common that a genus is identified, but the user will need to check other resources on how to distinguish between the species identified in the database.

**Limitations of this tool:** While useful, this tool is limited in several ways. The biggest limitation is that the species must be entered in the database to be found. With over 3,000 plants found in Wisconsin, adding all plants would limit the usefulness of this tool. The goal of this database is to help identify weeds and/or invasive plants, *not all plants of Wisconsin*. This allowed for a smaller set of species (approx. 10%) to be entered and allow for selection of the appropriate species while entering only a few characteristics. Some weed/invasive plants were omitted from this database as species selection focused on commonly found species to Wisconsin. Due to this, new invaders, or species that are not known to be present in Wisconsin have not been included. In addition, ornamental plants will also not appear on this database unless they have been documented to be weedy/invasive in Wisconsin.

**Feedback:** If you use this website please fill out the survey at the bottom of the search page. It asks if the plant was identified correctly, and has a space provided that allows for the user to provide comment. Any information given by the user will help document the usefulness of this tool, and allow for comments on how to improve the database in the future. I also welcome any suggested additions to the database species list, as unfortunately several species that are not currently common in Wisconsin will be so in the near future.

Figure 2: Demonstration of the second step of the weed identification tool for purple loosestrife

The screenshot shows a web form for identifying weeds. The left side is titled "Where was the weed found?" and includes sections for "Agriculture field:", "natural and grazed areas (non-crop):", "Urban:", "General characteristics", "Growth Form:", "Life Cycle:", "Tendrils:", "Produces milky sap:", "Leaf characteristics", "If leaf is simple:", "If leaf is compound:", "Leaf margin:", "Petioles:", "Leaf hairs:", and "Spines/thorns/prickles:". The right side is titled "Stem characteristics" and includes "Stems square:", "Leaves on flowering stems:", "Spines/thorns/prickles:", "Floral characteristics", "Flower color:", and "Flower symmetry:". A "search database" button is at the bottom. The "wetland/riparian" option is selected in the "natural and grazed areas" dropdown, and "blue-purple" is selected in the "Flower color" dropdown.

Figure 3: Demonstration of the result of the search for a plant found in a wetland/riparian area, with square stems, and purple flower color. Thumbnails can then be enlarged to confirm identification.

Your database search has yielded 2 possible matches found in (WI)

Scientific Name	Common Name	Pictures
Lythrum salicaria	purple loosestrife	
Mentha arvensis	wild mint field mint	